



Shire of Northam
Heritage, Commerce and Lifestyle

Shire of Northam

Minutes

Ordinary Council Meeting

16 October 2019



DISCLAIMER

In certain circumstances members of the public are not entitled to inspect material, which in the opinion of the Chief Executive Officer is confidential, and relates to a meeting or a part of a meeting that is likely to be closed to members of the public.

No responsibility whatsoever is implied or accepted by the Shire of Northam for any act, omission, statement or intimation occurring during Council or Committee meetings.

The Shire of Northam disclaims any liability for any loss whatsoever and howsoever caused arising out of reliance by any person or legal entity on any such act, omission or statement of intimation occurring during Council or Committee meetings.

Any person or legal entity who acts or fails to act in reliance upon any statement, act or omission made in a Council or Committee meeting does so at that person's or legal entity's own risk.

In particular and without derogating in any way from the broad disclaimer above, in any discussion regarding any planning application or application for a licence, any statement or intimation of approval made by any member or Officer of the Shire of Northam during the course of any meeting is not intended to be and is not taken as notice of approval from the Shire of Northam.

The Shire of Northam advises that anyone who has any application lodged with the Shire of Northam must obtain and should only rely on WRITTEN CONFIRMATION of the outcome of the application and any conditions attaching to the decision made by the Shire of Northam in respect of the application.

The Shire of Northam advises that any plans or documents contained within this agenda may be subject to copyright law provisions (*Copyright Act 1968*, as amended) and that the express permission of the copyright owner(s) should be sought prior to their reproduction. It should be noted that copyright owners are entitled to take legal action against any persons who infringe their copyright. A reproduction of material that is protected by copyright may represent a copyright infringement.

Contents

1.	DECLARATION OF OPENING	5
2.	ATTENDANCE.....	5
2.1	APOLOGIES.....	5
2.2	APPROVED LEAVE OF ABSENCE	5
3.	DISCLOSURE OF INTERESTS.....	6
4.	ANNOUNCEMENT BY THE PRESIDING MEMBER (WITHOUT DISCUSSION)	7
5.	PUBLIC QUESTION TIME	9
5.1	PUBLIC QUESTIONS.....	9
6.	RESPONSE TO PREVIOUS PUBLIC QUESTIONS TAKEN ON NOTICE	9
7.	RECEIVING OF PETITIONS, PRESENTATIONS AND DEPUTATIONS	9
7.1	PETITIONS.....	9
7.2	PRESENTATIONS	9
7.3	DEPUTATIONS.....	9
8.	APPLICATION FOR LEAVE OF ABSENCE.....	9
9.	CONFIRMATION OF MINUTES	10
9.1	ORDINARY COUNCIL MEETING HELD 18 SEPTEMBER 2019	10
9.2	NOTES FROM THE COUNCIL FORUM MEETING HELD 9 OCTOBER 2019	10
10.	ITEMS BROUGHT FORWARD FOR THE CONVENIENCE OF THOSE IN THE PUBLIC GALLERY	23
11.	REPORTS OF COMMITTEE MEETINGS	23
11.1	COMMUNITY SAFETY COMMITTEE MEETING HELD ON 17 SEPTEMBER 2019	23
11.2	AUDIT COMMITTEE MEETING HELD ON 9 OCTOBER 2019.....	53
12.	OFFICER REPORTS	248
12.1	CEO'S Office	248
12.1.1	November 2019 Council Forum and Ordinary Council Meeting.....	248
12.2	ENGINEERING SERVICES.....	252
12.2.1	Vehicle & Plant Management Policy.....	252
12.2.2	Shire of Northam W5.6 Verges Policy Review	282
12.2.3	Wheatbelt Secondary Freight Network (WSFN)	305
12.3	DEVELOPMENT SERVICES	335

12.3.1	Proposed Warehouse & Dome Stores – 61 Old York Rd, Northam.....	335
12.3.2	Proposed Local Planning Policy No. 25 – Spencers Brook Special Control Area	351
12.4	CORPORATE SERVICES.....	370
12.4.1	Accounts & Statements of Accounts – September 2019 ..	370
12.4.2	Financial Statement for the period ending 30 September 2019	417
12.4.3	Lease of A322 Fluffy Ducklings Day Care	435
12.4.4	Adoption of Local Laws 2019	441
12.5	COMMUNITY SERVICES	524
13.	MATTERS BEHIND CLOSED DOORS	524
13.1	PURCHASE OF A12173.....	524
13.2	SHIRE OF NORTHAM LICENSING SERVICES	525
14.	MOTIONS OF WHICH PREVIOUS NOTICE HAS BEEN GIVEN.....	526
15.	URGENT BUSINESS APPROVED BY DECISION	527
16.	DECLARATION OF CLOSURE	527

1. DECLARATION OF OPENING

The Shire President, Cr C R Antonio declared the meeting open at 5:30pm.

2. ATTENDANCE

Council:

Shire President

Deputy Shire President

Councillors

C R Antonio

M P Ryan

J E G Williams

A J Mencshelyi

T M Little

C P Della

Staff:

Chief Executive Officer

Executive Manager Community Services

Executive Manager Engineering Services

Executive Manager Development Services

Executive Manager Corporate Services

Executive Assistant – CEO

Coordinator Governance / Administration

Manager Health and Environment

Killara Manager

Customer Service Officer

J B Whiteaker

R Rayson

C D Kleynhans

C B Hunt

C Young

A C McCall

C F Greenough

C E Sadleir

N Hampton

S Douglas entered at 5:31pm
and left at 5:31pm

Gallery:

Avon Valley Advocate

Public

Eliza Wynn

Sally Hart

Maren Lavery

Colby Best

Heather Meiklem

2.1 APOLOGIES

Councillor

R W Tinetti

J Proud

C L Davidson (no formal
apology received)

2.2 APPROVED LEAVE OF ABSENCE

Cr S B Pollard has been granted leave of absence from 26 August 2019 to 1 November 2019 (inclusive).

3. DISCLOSURE OF INTERESTS

Item Name	Item No.	Name	Type of Interest	Nature of Interest
Proposed Local Planning Policy No. 25 – Spencers Brook Special Control Area	12.3.2	Cr J E G Williams	Impartiality	The submitter requesting his property be removed from the SCA is well known to her through membership of the Spencers Brook Progress Association. Impartiality only, matter was discussed at Progress.
Shire of Northam Licensing Services	13.2	Cr J E G Williams	Impartiality	One of her non-dependent children is a Shire employee.

Ms Douglas entered the meeting at 5:31pm and left at 5:31pm.

The Coordinator Governance / Administration left the meeting at 5:31pm.

S

4. ANNOUNCEMENT BY THE PRESIDING MEMBER (WITHOUT DISCUSSION)

Visitations and Consultations	
21/09/19	Television Interview with Channel 7 on Social Media Posts
21/09/19	Northam Hockey Turf – Official Opening
22/09/19	Southern Brook Annual Spring Picnic
23/09/19	Shaping our State's Future event – East Perth
25/09/19	MMM Radio Interview "I Love Avon" campaign
27/09/19	Police Remembrance Day Ceremony – Wheatbelt in Northam
29/09/19	Perth Royal Show Rural Ambassador Dinner - Claremont
30/09/19	Queen's Birthday Holiday
01/10/19	MMM Fortnightly Radio Interview
03/10/19	Northam Chamber of Commerce Business After Hours
05/10/19	Lions Northam Community Markets
06/10/19	Avro Anson Memorial Service - Mokane
06/10/19	Northam Race Club Ladies Day
09/10/19	Silver Wings Quiz Day - Wundowie
11/10/19	Wheatbelt Health Network NAIDOC Event - Northam
12/10/19	Official Opening Mobil Service Station - Malabaine
12/10/19	Toodyay Show
12/10/19	Wundowie Iron Festival
14/10/19	MMM Fortnightly Radio Interview
Upcoming Events	
19/10/19	Local Government Election – Northam Shire
21/10/19	Induction of Newly Elected Northam Shire Councillors
21/10/19	Northam Senior High School Year 12 Graduation Ceremony
24/10/19	Citizenship Ceremony - Northam
25/10/19	Tidy Town Sustainable Community Awards Ceremony - Perth
28/10/19	MMM Fortnightly Radio Interview
28/10/19	Freshstart Client Graduation - Northam
02/11/19	Lions Community Markets – Northam
02/11/19	Sponsored Art Show - Kellerberrin
05/11/19	Melbourne Cup Day
06/11/19	S. Hatherley Retirement Function - Northam
07/11/19	Northam Chamber of Commerce Business after Hours
11/11/19	MMM Fortnightly Radio Interview
11/11/19	Remembrance Day
14/11/19	Local Emergency Management Committee Meeting - Northam

Operational Matters:

Local Government Elections

Every two years, Local Government Elections are held. With postal elections being held on the 19th October, I encourage all registered voters to have your say. After receiving your postal voting pack, please make your choice, make your vote, and return your completed form in the reply-paid envelope.

Thank you to all of the people who have nominated for a position on the Shire of Northam Council. Good luck in the upcoming election for all candidates.

Thank you to Councillor Chris Davidson for the past four years service as a West Ward representative for the Shire of Northam. Councillor Davidson has decided not to nominate for the upcoming election

Australia Day Citizen of the Year

With a number of available categories in the Australia Day Citizen of the Year awards, can you think of someone, who you believe, has contributed greatly to our Shire or the community in general? If so, please nominate them for the Australia Day Citizen of the Year Awards. Nominations close on the 31st October 2019. Finalists and Winners are announced on Australia Day. Further Details are available on the Shire of Northam website.

Community

A quick visit to the Shire of Northam Website - Events Page - demonstrates how valuable our community is. There are multiple events listed, ranging from a number of "Pink Up Northam" events, the Wundowie Iron Festival, to the Avon Valley Business Excellence Awards, the Northam Cup and the Link Theatre October Production. Volunteers and community participation contribute greatly toward our Shire.

Strategic Matters:

The Aquatic Centre continues progress toward completion. The due date for opening remains as January 2020. The construction of the new water slides is expected to commence soon.

There are many private commercial developments nearing completion or opening soon. These developments show that the private sector sees what our Shire has to offer and provides, not only additional employment opportunities, but also contributes toward an improved amenity.

5. PUBLIC QUESTION TIME

5.1 PUBLIC QUESTIONS

Nil.

6. RESPONSE TO PREVIOUS PUBLIC QUESTIONS TAKEN ON NOTICE

Nil.

The Coordinator Governance / Administration entered the meeting at 5:33pm.

7. RECEIVING OF PETITIONS, PRESENTATIONS AND DEPUTATIONS

7.1 PETITIONS

Nil.

7.2 PRESENTATIONS

Nil.

7.3 DEPUTATIONS

Nil.

8. APPLICATION FOR LEAVE OF ABSENCE

RECOMMENDATION / COUNCIL DECISION

Minute No: C.3772

Moved: Cr Little

Seconded: Cr Mencshelyi

That Council grant Cr C P Della leave of absence from 11 November 2019 to 30 November 2019 (inclusive).

CARRIED 6/0

RECOMMENDATION / COUNCIL DECISION

Minute No: C.3773

Moved: Cr Williams

Seconded: Cr Mencshelyi

That Council grant Cr R W Tinetti leave of absence from 19 November 2019 to 4 December 2019 (inclusive).

CARRIED 6/0

9. CONFIRMATION OF MINUTES

9.1 ORDINARY COUNCIL MEETING HELD 18 SEPTEMBER 2019

RECOMMENDATION / COUNCIL DECISION

Minute No: C.3774

Moved: Cr Ryan

Seconded: Cr Della

That the minutes of the Ordinary Council meeting held on Wednesday, 18 September 2019 be confirmed as a true and correct record of that meeting.

CARRIED 6/0

9.2 NOTES FROM THE COUNCIL FORUM MEETING HELD 9 OCTOBER 2019

RECOMMENDATION / COUNCIL DECISION

Minute No: C.3775

Moved: Cr Williams

Seconded: Cr Mencshelyi

That Council receive the notes from the Council Forum meeting held Wednesday, 9 October 2019.

CARRIED 6/0

Attachment 1



Shire of Northam
Heritage, Commerce and Lifestyle

Shire of Northam

Notes

Council Forum Meeting

9 October 2019



DISCLAIMER

These notes are yet to be dealt with by the Council. The minutes of the meeting held to discuss this agenda should be read to ascertain the decision of the Council.

In certain circumstances members of the public are not entitled to inspect material, which in the opinion of the Chief Executive Officer is confidential, and relates to a meeting or a part of a meeting that is likely to be closed to members of the public.

No responsibility whatsoever is implied or accepted by the Shire of Northam for any act, omission, statement or intimation occurring during Council or Committee meetings.

The Shire of Northam disclaims any liability for any loss whatsoever and howsoever caused arising out of reliance by any person or legal entity on any such act, omission or statement of intimation occurring during Council or Committee meetings.

Any person or legal entity who acts or fails to act in reliance upon any statement, act or omission made in a Council or Committee meeting does so at that person's or legal entity's own risk.

In particular and without derogating in any way from the broad disclaimer above, in any discussion regarding any planning application or application for a licence, any statement or intimation of approval made by any member or Officer of the Shire of Northam during the course of any meeting is not intended to be and is not taken as notice of approval from the Shire of Northam.

The Shire of Northam advises that anyone who has any application lodged with the Shire of Northam must obtain and should only rely on WRITTEN CONFIRMATION of the outcome of the application and any conditions attaching to the decision made by the Shire of Northam in respect of the application.

The Shire of Northam advises that any plans or documents contained within this agenda may be subject to copyright law provisions (*Copyright Act 1968*, as amended) and that the express permission of the copyright owner(s) should be sought prior to their reproduction. It should be noted that copyright owners are entitled to take legal action against any persons who infringe their copyright. A reproduction of material that is protected by copyright may represent a copyright infringement.

Council Forum Meeting Notes
9 October 2019



Preface

When the Chief Executive Officer approves these Notes for distribution they are in essence "informal notes."

At the next Ordinary Meeting of Council the Notes will be received, subject to any amendments made by the Council. The "Received" Notes are then signed off by the Presiding Person.

Please refer to the Ordinary Council meeting agenda and minutes for further information and details in relation to the matters and items discussed at the Forum meeting.

Unconfirmed Notes

These notes were approved for distribution on 11 October 2019.



CLINTON KLEYNHANS
ACTING CHIEF EXECUTIVE OFFICER

Received Notes

These notes were received at an Ordinary Meeting of Council held on 16 October 2019.



Signed:

Note: *The Presiding Member at the meeting at which the minutes were confirmed is the person who signs above.*

Contents

1.	DECLARATION OF OPENING.....	6
2.	ATTENDANCE.....	6
2.1	APOLOGIES.....	6
2.2	APPROVED LEAVE OF ABSENCE	6
3.	DISCLOSURE OF INTERESTS.....	6
4.	ANNOUNCEMENT BY THE PRESIDING MEMBER (WITHOUT DISCUSSION)	7
5.	PUBLIC QUESTION TIME	7
5.1	PUBLIC QUESTIONS.....	7
6.	RESPONSE TO PREVIOUS PUBLIC QUESTIONS TAKEN ON NOTICE	7
7.	RECEIVING OF PETITIONS, PRESENTATIONS AND DEPUTATIONS	7
7.1	PETITIONS.....	7
7.2	PRESENTATIONS	7
7.3	DEPUTATIONS.....	7
8.	APPLICATION FOR LEAVE OF ABSENCE.....	7
9.	CONFIRMATION OF MINUTES	7
9.1	ORDINARY COUNCIL MEETING HELD 18 SEPTEMBER 2019	7
9.2	NOTES FROM THE COUNCIL FORUM MEETING HELD 9 OCTOBER 2019	7
10.	ITEMS BROUGHT FORWARD FOR THE CONVENIENCE OF THOSE IN THE PUBLIC GALLERY	7
11.	REPORTS OF COMMITTEE MEETINGS	8
11.1	COMMUNITY SAFETY COMMITTEE MEETING HELD ON 17 SEPTEMBER 2019	8
12.	OFFICER REPORTS	8
12.1	CEO'S Office	8
12.1.1	November 2019 Council Forum and Ordinary Council Meeting.....	8
12.2	ENGINEERING SERVICES.....	8
12.2.1	Vehicle & Plant Management Policy.....	8
12.2.2	Shire of Northam W5.6 Verges Policy Review	9
12.2.3	Wheatbelt Secondary Freight Network (WSFN)	9
12.3	DEVELOPMENT SERVICES	9
12.3.1	Proposed Warehouse & Dome Stores – 61 Old York Rd, Northam.....	9

Council Forum Meeting Notes
9 October 2019

12.3.2	Proposed Local Planning Policy No. 25 – Spencers Brook Special Control Area	10
12.4	CORPORATE SERVICES	11
12.4.1	Accounts & Statements of Accounts – September 2019 ...	11
12.4.2	Financial Statement for the period ending 30 September 2019	11
12.4.3	Lease of A322 Fluffy Ducklings Day Care	11
12.4.4	Adoption of Local Laws 2019	11
12.5	COMMUNITY SERVICES	12
13.	MATTERS BEHIND CLOSED DOORS	12
13.1	PURCHASE OF A12173.....	12
13.2	SHIRE OF NORTHAM LICENSING SERVICES	12
14.	MOTIONS OF WHICH PREVIOUS NOTICE HAS BEEN GIVEN	12
15.	URGENT BUSINESS APPROVED BY DECISION	12
16.	DECLARATION OF CLOSURE	12

Council Forum Meeting Notes
9 October 2019



1. DECLARATION OF OPENING

The Shire President, Cr C R Antonio declared the meeting open at 5:30pm.

2. ATTENDANCE

Council:

Shire President
Councillors

C R Antonio
J E G Williams
R W Tinetti
A J Mencshelyi
T M Little
C P Della

Staff:

Acting Chief Executive Officer / Executive
Manager Engineering Services
Executive Manager Development Services
Executive Manager Corporate Services
Executive Assistant – CEO
Coordinator Governance / Administration
Manager Planning Services

C D Kleynhans
C B Hunt
C Young
A C McCall
C F Greenough
J Jurmann left at 6:02pm

Gallery:

Avon Valley Advocate
Public

Eliza Wynn
Heather Meiklem
Adelle Tandy arrived at
5:38pm and left at 6:02pm
Nick Tandy arrived at 5:38pm
and left at 6:02pm

2.1 APOLOGIES

Chief Executive Officer
Executive Manager Community Services
Councillor

J B Whiteaker
R Rayson
J Proud

2.2 APPROVED LEAVE OF ABSENCE

Cr S B Pollard has been granted leave of absence from 26 August 2019 to
1 November 2019 (inclusive).

3. DISCLOSURE OF INTERESTS

Item Name	Item No.	Name	Type of Interest	Nature of Interest
Shire of Northam Licensing Services	13.2	Cr J E G Williams	Impartiality	One of her non-dependent children is a Shire employee.

Council Forum Meeting Notes
9 October 2019



4. ANNOUNCEMENT BY THE PRESIDING MEMBER (WITHOUT DISCUSSION)

No questions were raised in relation to this item.

5. PUBLIC QUESTION TIME

5.1 PUBLIC QUESTIONS

Nil.

6. RESPONSE TO PREVIOUS PUBLIC QUESTIONS TAKEN ON NOTICE

Nil.

7. RECEIVING OF PETITIONS, PRESENTATIONS AND DEPUTATIONS

7.1 PETITIONS

Nil.

7.2 PRESENTATIONS

Nil.

7.3 DEPUTATIONS

Nil.

8. APPLICATION FOR LEAVE OF ABSENCE

No questions were raised in relation to this item.

9. CONFIRMATION OF MINUTES

9.1 ORDINARY COUNCIL MEETING HELD 18 SEPTEMBER 2019

No questions were raised in relation to this item.

9.2 NOTES FROM THE COUNCIL FORUM MEETING HELD 9 OCTOBER 2019

No questions were raised in relation to this item.

10. ITEMS BROUGHT FORWARD FOR THE CONVENIENCE OF THOSE IN THE PUBLIC GALLERY

Nil.

11. REPORTS OF COMMITTEE MEETINGS

11.1 COMMUNITY SAFETY COMMITTEE MEETING HELD ON 17 SEPTEMBER 2019

Clarification was sought in relation to the following:

- The funding of \$227,000 for CCTV in Wundowie and whether there are any issues with initiating the project? The Executive Manager Corporate Services advised that staff are currently seeking technical advice on the specifications. Once this has been received the project will be tendered. It is anticipated that the tender will be advertised in approximately 1 month with the project being completed this financial year.
- The state government standards. Cr Williams advised that the standards are no longer in place and they are trying to ascertain the equivalent of the previous standards.
- The reference to liaising with the WA Police and the matter relating to the CCTV being put on hold (page 13 of the Committee minutes). The Executive Manager Development Services advised that the Northam CCTV was state government funded with Wundowie being funded by the federal government. It was raised that there was difficulty with Northam and therefore staff are getting specifications for Wundowie.

Mrs Adelle Tandy and Mr Nick Tandy entered the meeting at 5:38pm.

12. OFFICER REPORTS

12.1 CEO'S Office

12.1.1 November 2019 Council Forum and Ordinary Council Meeting

No questions were raised in relation to this item.

12.2 ENGINEERING SERVICES

12.2.1 Vehicle & Plant Management Policy

Clarification was sought in relation to the following:

- Whether there were any notes taken at the workshop. The Acting Chief Executive Officer outlined that there were short notes taken which will be provided to Elected Members.
- Whether there will be cost savings for Council. The Acting Chief Executive Officer advised that there will be approximately \$500,000 of savings over the period of a 10 year replacement program, this is for administration vehicles alone. It was advised that there is no change in the strategy for heavy plant and the recommendation is reflective of this.

Council Forum Meeting Notes
9 October 2019



12.2.2 Shire of Northam W5.6 Verges Policy Review

Clarification was sought in relation to the following:

- Whether there were any notes taken at the workshop. The Acting Chief Executive Officer outlined that there were short notes taken which will be provided to Elected Members.
- Whether the policy applies to the whole Shire, including rural verges. The Acting Chief Executive Officer confirmed it applies to the whole Shire including rural areas.
- Whether the reference to the ratepayer should not remove or prune any trees on a verge and whether this includes shrubs in rural areas. The Acting Chief Executive Officer advised that it is specific to trees. A further query was raised in relation to trees that pop up. The Acting Chief Executive Officer advised that the policy is aimed at established trees, a new tree can be pulled out, along with verges that have trees planted by the resident with the Shire's approval. The maintenance of these is the responsibility of the resident.

12.2.3 Wheatbelt Secondary Freight Network (WSFN)

Clarification was sought in relation to the following:

- Whether there is only the one road for Northam being Yilgarn Avenue. The Acting Chief Executive Officer confirmed there is only the one road, however repairs of this road is estimated to be up to \$1 million.
- Whether the recent workshop on RAV routes will affect this? The Acting Chief Executive Officer advised that the workshop was relating to a separate matter which was in lead up to the harvest season. Yilgarn Avenue is included as it feeds the assembly area near Great Eastern Highway. As Northam is a regional centre there will typically be other roads feeding into Northam. Other roads within the Shire that carry grains are already being addressed for upgrades through the RRG process for road funding. Such as Jennapullin Road, Southern Brook Road and Spencers Brook Road.

12.3 DEVELOPMENT SERVICES

12.3.1 Proposed Warehouse & Dome Stores – 61 Old York Rd, Northam

Clarification was sought in relation to the following:

- The submission received in relation to the fencing and drainage and whether this has been appropriately addressed by conditions. The Executive Manager Development Services advised that the objector was advised of the relevant conditions in relation to this and they have not responded with any further concerns.

Council Forum Meeting Notes
9 October 2019



- The submission relating to the lay of the land changing with 1m backfill. The Executive Manager Development Services advised that approval for the backfill has been provided.
- Condition 6 relating to acoustic fencing and whether retaining along the fence line is part of the fence construction. The Manager Planning Services confirmed that retaining is included. It was further queried whether this needs to be specified in the condition. The Manager Planning Services advised that this will be clarified in the condition.
- Whether the timeframes conflict in the Background / Detail of the report. The Executive Manager Development Services advised that there are different timeframes for WAPC approvals and local government approvals. The Manager Planning Services advised that the recommendation is to substantially commence and doesn't require completion within this timeframe.
- The distance from water courses and whether this imposes any additional requirements. The Executive Manager Development Services advised that the site may be on a reticulated sewer however took the question on notice. Since the Council Forum, the following information has been included within the Officers report in the Ordinary Council meeting agenda:

The WA Government Sewerage Policy came into effect on 25 September 2019, which recommends a separation distance of 100m between watercourses and on-site sewerage systems. The development plans previously approved by Council (P18108) indicated that an alternative treatment unit would be installed to manage sewerage on-site and that the irrigation area would be located behind the main building. Due to the introduction of this policy, further investigation may be required to determine if secondary treatment may be required depending on the results of the site and soil evaluation. Noting that the system would be the subject of a Department of Health approval and further consultation with the Department of Water and Environmental Regulation.

- The location of the domes. The Manager Planning Services outlined that the location is detailed on page 135. Condition 4 of the recommendation requests more detail in relation to these.

12.3.2 Proposed Local Planning Policy No. 25 – Spencers Brook Special Control Area

The Shire President allowed a deputation from Mr Nick Tandy as they arrived to the meeting after item 7.3 – Deputations.

Summary of Deputation by Nick Tandy:

Council Forum Meeting Notes
9 October 2019



- Made a submission to SAT in relation to their development application for their property in this area.
- Raised concerns about the amalgamation, they own property 21 and are concerned they will be stuck in between amalgamated lots. They cannot purchase 22 as this is not for sale.

Clarification was sought in relation to the following:

- The Executive Manager Development Services advised that an updated plan will be provided to detail the correct ownership. In addition the Development Plan within the Policy will be updated to reflect that Lot 21 is not suggested for amalgamation.
- Whether landowners are compelled to amalgamate. The Executive Manager Development Services advised that there is not a great deal of development opportunity on the lots and therefore most landowners are happy with this proposal given they are paying rates on land which cannot be developed.

Mrs Adelle Tandy and Mr Nick Tandy left the meeting at 6:02pm.

The Manager Planning Services left the meeting at 6:02pm.

12.4 CORPORATE SERVICES

12.4.1 Accounts & Statements of Accounts – September 2019

No questions were raised in relation to this item.

12.4.2 Financial Statement for the period ending 30 September 2019

No questions were raised in relation to this item.

The Executive Manager Corporate Services advised that the rates graph is incorrect and will be updated for the Ordinary Council Meeting agenda.

12.4.3 Lease of A322 Fluffy Ducklings Day Care

Clarification was sought in relation to the following:

- Whether this item has been presented to Council previously. The Coordinator Governance / Administration advised that this was withdrawn from a previous Council meeting as staff had concerns that Fluffy Ducklings were not supportive. Staff have since received confirmation that they wish to move to REED.

12.4.4 Adoption of Local Laws 2019

Clarification was sought in relation to the following:

Council Forum Meeting Notes
9 October 2019



- The definition of nuisance in the Cat Local Law does not correlate. The Coordinator Governance / Administration advised that this will be corrected in the Ordinary Council meeting agenda.

12.5 COMMUNITY SERVICES

Nil.

The Gallery left the meeting at 6:07pm.

13. MATTERS BEHIND CLOSED DOORS

13.1 PURCHASE OF A12173

Refer to Confidential Addendum.

Cr J E G Williams declared an "impartiality" interest in item 13.2 – Shire of Northam Licensing Services as one of her non-dependent children is a Shire employee.

13.2 SHIRE OF NORTHAM LICENSING SERVICES

Refer to Confidential Addendum.

14. MOTIONS OF WHICH PREVIOUS NOTICE HAS BEEN GIVEN

Clarification was sought in relation to whether there is parking at the rear. The Acting Chief Executive Officer advised that staff are not aware of any parking at the rear.

The Acting Chief Executive Officer advised that there is more involved than putting up signage for the disabled bay. It was advised that readjusting the kerb is required to raise the bay. There is also the possibility that the drainage gully will need to be relocated and this will require staff time to investigate. The Acting Chief Executive Officer advised that if there were no drainage issues, the cost was estimated at \$10,000 to \$15,000.

15. URGENT BUSINESS APPROVED BY DECISION

Nil.

16. DECLARATION OF CLOSURE

The Shire President, Cr C R Antonio declared the meeting closed at 6:31pm.

10. ITEMS BROUGHT FORWARD FOR THE CONVENIENCE OF THOSE IN THE PUBLIC GALLERY

Nil.

11. REPORTS OF COMMITTEE MEETINGS

11.1 COMMUNITY SAFETY COMMITTEE MEETING HELD ON 17 SEPTEMBER 2019

Receipt of Minutes:

RECOMMENDATION / COUNCIL DECISION
Minute No: C.3776
Moved: Cr Williams
That Council receive the minutes from the Community Safety Committee meeting held on 17 September 2019.
CARRIED 6/0

Adoption of Recommendations:

RECOMMENDATION / COUNCIL DECISION
Minute No: C.3777
Moved: Cr Williams
That Council:
<ol style="list-style-type: none">1. Investigate the State Government standard for operating CCTV Systems to use in the State;2. Accept the update of the Community Safety and Crime Prevention Plan provided;3. Adopts the revised Terms of Reference as per Attachment 2; and4. Accept the report of Night Hoops 2019.
CARRIED 6/0

Attachment 1



Shire of Northam

Minutes

Community Safety Committee

17 September 2019

Community Safety Committee Meeting Minutes
17 September 2019



DISCLAIMER

These minutes have yet to be dealt with by the Council. The Recommendations shown at the foot of each item have yet to be considered by the Council and are not to be interpreted as being the position of the Council. The minutes of the meeting held to discuss this agenda should be read to ascertain the decision of the Council.

In certain circumstances members of the public are not entitled to inspect material, which in the opinion of the Chief Executive Officer is confidential, and relates to a meeting or a part of a meeting that is likely to be closed to members of the public.

No responsibility whatsoever is implied or accepted by the Shire of Northam for any act, omission, statement or intimation occurring during Council or Committee meetings.

The Shire of Northam disclaims any liability for any loss whatsoever and howsoever caused arising out of reliance by any person or legal entity on any such act, omission or statement of intimation occurring during Council or Committee meetings.

Any person or legal entity who acts or fails to act in reliance upon any statement, act or omission made in a Council or Committee meeting does so at that person's or legal entity's own risk.

In particular and without derogating in any way from the broad disclaimer above, in any discussion regarding any planning application or application for a licence, any statement or intimation of approval made by any member or Officer of the Shire of Northam during the course of any meeting is not intended to be and is not taken as notice of approval from the Shire of Northam.

The Shire of Northam advises that anyone who has any application lodged with the Shire of Northam must obtain and should only rely on WRITTEN CONFIRMATION of the outcome of the application and any conditions attaching to the decision made by the Shire of Northam in respect of the application.

The Shire of Northam advises that any plans or documents contained within this agenda may be subject to copyright law provisions (*Copyright Act 1968*, as amended) and that the express permission of the copyright owner(s) should be sought prior to their reproduction. It should be noted that copyright owners are entitled to take legal action against any persons who infringe their copyright. A reproduction of material that is protected by copyright may represent a copyright infringement.



Contents

- 1. DECLARATION OF OPENING.....4
- 2. ATTENDANCE4
 - 2.1 APOLOGIES4
 - 2.2 APPROVED LEAVE OF ABSENCE4
- 3. DISCLOSURE OF INTERESTS.....4
- 4. CONFIRMATION OF MINUTES.....5
 - 4.1 COMMITTEE MEETING HELD 19 JUNE 2019.....5
- 5. COMMITTEE REPORTS6
 - 5.1 COMMUNITY SAFETY AND CRIME PREVENTION PLAN UPDATE.....6
 - 5.2 REVIEW OF TERMS OF REFERENCE AND MEMBERSHIP OF THE COMMUNITY SAFETY COMMITTEE 20
 - 5.3 UPDATE OF NIGHT HOOPS 2019..... 26
- 6. GENERAL BUSINESS..... 29
- 7. URGENT BUSINESS APPROVED BY PERSON PRESIDING OR BY DECISION 29
- 8. DATE OF NEXT MEETING..... 29
- 9. DECLARATION OF CLOSURE 29

Community Safety Committee Meeting Minutes
17 September 2019



1. DECLARATION OF OPENING

Chairperson Cr Julie Williams declared the meeting open at 12.05pm

2. ATTENDANCE

Committee Members:

Chairperson	Cr Julie Williams
Wundowie Police	SGT Sarah Clarke
Local Youth Services Representative	Mr Darren Warland
Community Representative	Mr Denis Beresford
Department of Sport and Recreation	Ms Emma Draper
Holyoake	Ms Eloise Fewster
Northam Chamber of Commerce	Ms Esther Bliss
Department Education	Mrs Sharon Bray

Committee Ex-Officio Members:

Shire of Northam	Ms Jaime Hawkins
Shire of Northam	Ms Jordyn Budas

Guests:

Northam Police	Andrew Toop
Department of Communities – Child Protection and Family Support – Ms Deborah Chadwick	

2.1 APOLOGIES

Northam Police	SSGT David Hornsby
Local Youth Services Representative	Ms Jane Atterby
Northam Roadwise Committee	Mr Cliff Simpson
LDAG	Mrs Rose Power
Holyoake	Mr Peter Osborn
Department of Housing	Mr Attila Mencshelyi
Councillor	Cr Rob Tinetti
Councillor	Cr Michael Ryan
Executive Manager Community Services	Mr Ross Rayson

2.2 APPROVED LEAVE OF ABSENCE

3. DISCLOSURE OF INTERESTS

Nil.

4. CONFIRMATION OF MINUTES

4.1 COMMITTEE MEETING HELD 19 JUNE 2019

RECOMMENDATION

Minute No: CSC.053

Moved: Ms Esther Bliss
Seconded: SGT Sarah Clarke

That Committee accept the minutes of the Shire of Northam Community Safety Committee meeting held Tuesday, 18 June 2019 be confirmed as a true and correct record of that meeting.

CARRIED 8/0

Community Safety Committee Meeting Minutes
17 September 2019



5. COMMITTEE REPORTS

Ms Deborah Chadwick arrived at 12.07pm

5.1 COMMUNITY SAFETY AND CRIME PREVENTION PLAN UPDATE

Address:	
Owner:	Shire of Northam
Applicant:	
File Reference:	1.3.12.1
Reporting Officer:	Community Development Officer
Responsible Officer:	Executive Manager Community Services
Officer Declaration of Interest:	
Voting Requirement:	Simple majority
Press release to be issued:	No

BRIEF

To update the Committee on the Community Safety and Crime Prevention Plan actions.

ATTACHMENTS

Attachment 1: Community Safety & Crime Prevention Plan Action Plan Update

BACKGROUND / DETAILS

The Shire of Northam Community Safety and Crime Prevention (CSCP) Plan 2017-2021 is a four year strategic outlook for the Shire of Northam that aims to map the issues of primary concern to the community and document the strategies and partnerships to deal with these issues.

Together with key partners, the Shire of Northam is committed to ensuring continual improvements to community safety with a particular emphasis on minimising the occurrence and opportunity for antisocial and criminal activity.

The CSCP Plan 2017-2021 has brought all of the current data together to help the Committee to understand 'What is the Northam story'. This will help the Committee to reconcile where the facts and the perceptions differ.

CONSIDERATIONS

Strategic Community / Corporate Business Plan

Objective: Create an environment that provides for a caring and healthy community.

Strategy: Provide community services to uphold public safety standards.

Community Safety Committee Meeting Minutes
17 September 2019



Action: Review and implement the Shire of Northam Community Safety and Crime Prevention Plan

Financial / Resource Implications

Council has an annual budget allocation for Community Safety and Crime Prevention

Legislative Compliance

N/A

Policy Implications

N/A

Stakeholder Engagement / Consultation

There has been ongoing engagement and consultation with stakeholders of the Community Safety & Crime Prevention Plan.

Risk Implications

- Reputational – Medium
 - Community safety is an area of high public concern.
- Financial – Low
 - Actions of the Community Safety Committee have been implemented within Shire Budget Allocations.
- Compliance – Low
 - The implementation of the Community Safety and Crime Prevention Plan complies with Shire of Northam Policy and the Local Government Act 1995.
- Legal – Low
 - There is no legal risk should all polices be considered.

OFFICER'S COMMENT

The Shire of Northam's Community Development Officer will provide an update on recent activities.

Criminal or Offending Behaviour

- Crime Statistics – latest Shire of Northam Crime Statistics provided by WALGA.
- Update from Northam Police.
- Introduction of new Wundowie Police OIC SGT Sarah Clarke. SGT Clarke to provide update from Wundowie Police.
- Action Plan update – Focus Area 1, Criminal & Offending Behaviour:
 - The majority of actions from this section of the Community Safety Plan have been implemented. Outstanding actions include:
 - Investigating youth drop in opportunities
 - Supporting PCYC and/or Avon Community Services to extend/develop drop-in-services.
 - Investigate street chaplaincy service.

Community Safety Committee Meeting Minutes
17 September 2019



- Develop Shire of Northam Youth leadership network.
- Night Hoops 2019 6 week program was run between 10th August – 14th September. To be discussed in agenda item 5.3.

Community Awareness

- Action Plan update – Focus Area 2, Community Awareness.
 - Social media communications are back on track with a minimum of one community safety message being scheduled to be posted per month.
 - Variable message sign is also being used to promote community safety messages – August was Crime Stoppers, "If you see something, say something".
The messages are now regarding firebreaks.
 - Community safety information and checklists are available via the Shire of Northam website.
 - eWatch program was cancelled by WA Police some time ago – opportunity for Shire of Northam to develop and promote our own eWatch type communication.
 - Outstanding actions for Community awareness include:
 - Actions to reduce untidy surroundings such as litter, abandoned vehicles, graffiti and damaged buildings.
 - Increasing the community confidence in Police
 - Promoting positive local stories to counteract the negative.
 - Promote the AFP ThinkUKnow cyber program.

Building Partnerships

- Action Plan update – Focus Area 3, Building Partnerships & Participation.
 - Need to review membership of the Community Safety Committee – to be discussed in agenda item 5.2.
 - Information capture on existing service providers not completed.
 - Northam Town Team established responding to problems in the CBD of Northam. The Town Team comprises of individuals who are passionate about improving Northam. Working collaboratively to make improvements in the Northam CBD and to activate spaces has the potential to improve the negative perception of Northam and make the community feel safe when utilising the spaces.

Community Design

- Action Plan update – Focus Area 4, Community Design
 - Obtaining quotes for a CPTED audit, including a lighting audit Grant funding will be sought to undertake the lighting audit.
 -
 - Due the complexities, of the Wundowie CCTV project Officers are currently seeking expressions of interest from suitably qualified consultants to assist in the design and tender of the system to ensure it meets the needs of the Wundowie community.

Community Safety Committee Meeting Minutes
17 September 2019

- o Northam CCTV has been experiencing a number of issues largely due to cocky caused damage to cabling. Insurance claims for the damage are being pursued and the Shire IT officers are working to get the system operational. At this stage the Shire of Northam is unable to fund any upgrades to the Northam system. As such, further grant funding will be sought to improve the operation of the Northam network and to increase the number of CCTV camera's in key locations, such as the Northam Youth Precinct.



DISCUSSION:

- Committee provided with handout of crime statistics from WALGA showing the monthly statistics for Shire of Northam and a graph comparing the last 3 years statistics, showing that most crimes have gone down.
- Andrew Toop, acting in SSGT David Hornsby place while away, stated that as of June 30 assaults are rising between non family members, in which the assaults are being reported but aren't being followed through by them, but the police are aware of the assaults.
- Denis Beresford added that looking at the increase in burglary Year to Date. He stated that an arrest of a drug dealer a few years ago reduced the burglary crimes, is there someone new in town, and are burglaries back on the rise again? Mr Toop responded advising that most of the individuals that were involved are mostly still in the "slot", but one released as of yesterday, and is back in the community but tabs are currently being kept on him.
- Denis Beresford questioned if cashless welfare that is to be rolled out in WA, is there a tie between the cards and the increase in crime? Mr Toop replied stating they don't have any intelligence or feedback as of this point. Sharon Bray commented from what is seen people get around other ways, buying legitimate items and then sell it off (i.e meat) or trade. Sarah Clarke advised that; that strategy has been seen up North with the shoplifting of meat.

Community Safety Committee Meeting Minutes
17 September 2019



- Committee reviewed the actions from the Community Safety & Crime Prevention Plan, focusing particularly on outstanding items.
- Ms Hawkins advised that there is a current revamping of the Shire newsletter at the moment, creating more space and having the option to present community safety messages suggested police put in updates of what is happening.
- Darren Warland advised that the perception of the Police is passed down by generations, but Policing and the Police mindset has changed. Mr Warland suggested that all agencies should work together to change the perception on the Police in town.
- Ms Esther Bliss updated the committee on what Town Teams is and what is done, involving the community, businesses and individuals, a meeting is being held next week. SGT Sarah Clarke asked if there is funding for town teams. Ms Esther Bliss replied that there is no funding, so you have to be creative.
- Ms Hawkins advised that a CPTED audit is still an outstanding item of the Community Safety Plan. External funding needs to be sought for this project.
- Ms Hawkins advised that the Shire are aware of issues with the Northam CCTV system, which have largely been caused by Corella's. The Shire is pursuing insurance claims to repair the damage.
- Mr Denis Beresford asked if there is a state plan on specific systems and cameras to use for CCTV. Ms Hawkins replied stating that the State CCTV Strategy is used extensively in the plan and that the Shire was in contact with them, but since contact was/has been lost. SGT Sarah Clarke added that she believes it no longer exists, also questioning because of the issues that have arisen with the Northam CCTV does that mean the Wundowie CCTV wont commence until Northam's system has finished? Ms Hawkins responded advising that they are working with the IT officers with getting back into it.

Community Safety Committee Meeting Minutes
17 September 2019

MOTION

Minute No: CSC.054

Moved: Mr Denis Beresford

Seconded: Mr Darren Warland

That Council investigate the State Government standard for operating CCTV Systems to use in the State.

CARRIED 8/0

RECOMMENDATION

Minute No: CSC.055

Moved: Mr Denis Beresford

Seconded: Ms Esther Bliss

That Council accept the update of the Community Safety and Crime Prevention Plan provided.

CARRIED 8/0

ACTION PLAN UPDATES - FOCUS AREA ONE

Criminal or Offending Behaviour

Objective 1.1 Reduce the opportunity for crime or offending behaviour.

Strategies	Actions	Progress / Comments
Increase the understanding of risk factors for potential victims of crime (including hotspots and prevention).	Promote and support eWatch - public circulation of crime facts and figures.	The eWatch program was a ceased by WA Police. Option to establish a local eWatch type program, or integrate with new format of monthly shire newsletter.
	Market at least one crime prevention tip per month as per the CSCP Communications Plan.	Community safety tips have been posted to the Shire's FB under the banner of "Community Safety Corner" on an ad-hoc basis. Shire Officers to routinely post in accordance with the communication plan. Alternative marketing strategy could be the Shire's monthly newsletter.
Raise community awareness about the relationship between crime prevention and the physical design of their property.	Educate and encourage community members to improve security measures in residential buildings through the provision of checklists and information.	Information & checklists available on Shire website. Shire currently investigating potential re-vamp of material and marketing strategies to get the information out to the community.
	Investigate and implement look, lock, leave vehicle safety signage program.	Vehicle security tips and information available through WA Police resources. No look, lock, leave signage.
	Promote the Burglar beware program.	Burglar beware message promoted on the VMS. Investigating other communication methods/resources.
	Provide the community with 'Do It Yourself' security audits.	Audits and informative resources available on the Shire's website. Marketing strategies to promote these are currently being investigated.
	Market at least one 'designing out crime' tip per month as	Tips available on Shire's website. To be promoted via

Community Safety Committee Meeting Minutes
17 September 2019

	per the CSCP Communications Plan.	Social media and potentially Shire newsletter.
Support the Northam Chamber of Commerce to engage with local business to reduce the opportunity for crime.	Encourage shop owners to ask for identification when suspicious shoppers request to use Pay Wave.	
	Distribute to the Chamber information brochures targeting shop owners to reduce crime.	
	Facilitate business education on appropriate CCTV.	
	Contribute crime prevention tips to the Chambers of Commerce monthly newsletter.	
	Heighten awareness about how to design out crime with appropriate shop layout.	
Deliver the Lock and Light program.	Promote the Lock and Light Program to potential community members.	The Lock & Light Program has ceased as it was found not viable, relying heavily on the availability of Police personnel to conduct the audits.
	Seek additional funding to continue the Lock and Light program.	

Objective 1.2 Increase community engagement and participation in identifying and reporting of crime.

Strategies	Actions	Progress / Comments
Develop a list of crime reporting and recording avenues. Promote to the community.	Promote the WA Police crime reporting methods.	Information available via the Shire's website. Promotional burst of Goodbye Graffiti app & online conducted via Shire's social media. Regular promotion via social media & newsletter to be investigated.
	Market the launch of and promote the State CCTV Register - residential and business CCTV register for Police to access.	Shire have been liaising with Police State CCTV team; however this project has now been put on hold by WA Police.
	Promote the Dob in a Dealer program.	Dob in a Dealer information available on Shire website. Other methods of promotion to be investigated.
	Market the Crime Stoppers brand.	Crime Stoppers brand promoted within Community Safety resources and messages.
Raise community awareness	Introduce a natural	Eyes on the Street is no

Community Safety Committee Meeting Minutes
17 September 2019



about how to identify a crime.	surveillance improvement program - Eyes on the Street.	longer a program run through WA Police, however the principles of Eyes on the Street are still promoted within the Shire and crime reporting methods available on the Shire's website.
	Promote and support eWatch.	eWatch program is no longer operating.

Objective 1.3 Maintain the Northam Shire Alcohol and Other Drugs Management Plan

Strategies	Actions	Progress / Comments
Support the delivery of the Northam Shire Alcohol and Other Drugs Management Plan.	Support and attend AODMP meetings. Include AODMP initiatives on the CSCP Marketing and Communications Plan.	The Northam Shire Alcohol & Other Drug Management Plan expired in 2017. A new plan the Northam Youth Wellbeing Plan has since been launched in its place. Shire Officers have been attending Youth Wellbeing Plan meetings and promoting the key messages of the Plan.

Objective 1.4 Reduce youth crime.

Strategies	Actions	Progress / Comments
Investigate youth focused night support/security program to service young people in the Shire of Northam.	Research and report on existing youth focused night support/security programs.	2019 series of Night Hoops Basketball implemented.
	Investigate youth drop-in opportunities and after hours support services that exist in the Shire of Northam and develop a 'map and gap' report to understand the requirements.	
	Support Northam PCYC and/or Avon Youth to extend/develop drop-in services.	
	Investigate street chaplaincy service.	
	Seek funding to implement youth focused support/security programs.	Ongoing. Community Crime Prevention Fund.
Support and facilitate collaborative youth engagement initiatives.	Work with stakeholders to plan collaborative youth engagement initiatives.	Ongoing. Liaising with Avon Community Services & PCYC regarding youth projects.
	Provide information about	Dedicated page on the

Community Safety Committee Meeting Minutes
17 September 2019

	services and activities for youth within the community.	Shire's website for Information & Activities for Youth
	Forward plan and support the provision of school holiday activities for youth.	Ongoing in liaison with youth providers. Inclusive School Holiday programs delivered each holiday and recent skateboarding & activation activities at the Northam and Wundowie Skate Parks
	Implement youth engagement activities at the Northam Youth Precinct to activate the space.	Skateboarding WA have visited Northam twice to deliver skateboarding workshops since the opening on the Northam Youth Precinct, with more workshops planned for the October holidays. Other youth providers have used the space for their activities.
	Implement youth engagement activities at the Wundowie Skate Park to activate the space.	Skateboarding workshop conducted in Wundowie previous school holidays.
	Drive the Keeping Kids in Schools program.	Keeping Kids in Schools Program is ongoing through participating businesses and with the support of the Chamber of Commerce.
	Create annual Youth Week activities and apply for funding to implement them.	Youth Week activities held in April. Youth Week 2020 grants currently being applied for.
	Development of a Shire of Northam youth leadership network to provide ideas for new initiatives, feedback on current initiatives and share information amongst young people.	
Create a Shire of Northam Youth Plan	Development of a Shire of Northam Youth Plan in collaboration with key youth stakeholders.	The Northam Youth Wellbeing Plan 2018 – 2020 has been developed, following on from the former AODMP. This plan was developed collaboratively with key stakeholders, including the Shire and these stakeholders hold regular meetings to progress the plan and report back.

ACTION PLAN UPDATES - FOCUS AREA TWO

Community Awareness

Objective 2.1 Improve the community perception of crime in the Shire of Northam.

Strategies	Actions	Progress / Comments
Implement the actions of the Shire of Northam CSCP Marketing and Communications Plan.	Promote community safety and crime prevention information on the Shire website and social media sites.	Community safety & crime prevention information is published on the Shire website & on social media on an ad-hoc basis.
	Contribute articles to eWatch monthly.	eWatch program is no longer operational.
	Implement monthly messaging on the variable digital messaging sign.	Ongoing. Crime stopper message currently displaying.
	Include articles in the Shire of Northam monthly newsletter to be published in the Avon Advocate.	The Shire newsletter is currently being redesigned and will be available electronically, not through the Advocate. The publication in the Advocate was always too tight on space to be able to include community safety messages.
	Schedule monthly social media posts following each CSC meeting.	Social media posts have been occurring on an ad hoc basis. Posts are now back to being scheduled monthly.
Reduce untidy surroundings such as litter, abandoned vehicles, graffiti and damaged buildings.	Promote Trolley Tracker program to report abandoned shopping trolleys.	Has occurred previously, but not recently. Will be scheduled for Community Safety Corner.
	Promote litter reporting procedures through placement of signage in highly littered areas of the Shire of Northam.	Keep Australia Beautiful Week recently promoted, including litter reporting.
	Promote Designing Out Crime Principals.	Designing out crime tips available on Shire's website
	Encourage community ownership of places (e.g. adopt a spot programs)	Some promotion of adopt-a-spot, with some community groups/members signing up.
	Anti-litter social media	Keep Australia Beautiful

Community Safety Committee Meeting Minutes
17 September 2019



	marketing	Week promoted.
	Participation in Keep Australia Beautiful campaigns.	Shire signed up as a Local Govt. supporter of Keep Australia Beautiful.
	School engagement and education in anti-litter.	School Clean-Up Australia information shared with schools. St Josephs school participated in 2019.
	Clean up Your Yard marketing	
	Promotion of support agencies that can help with improving living standards.	
Increase community confidence in the police.	Promotion of Police social media sites.	
	Promotion of Police initiatives	
Promote the positive	Promotion of positive local stories to counteract the heavily promoted negative stories. Include these in the Marketing and Communications Plan.	

Objective 2.2 Enable greater awareness of activities and projects across the Shire of Northam which address safety and security.

Strategies	Actions	Progress / Comments
Promote existing community education initiatives that target safety and security.	Implement relevant State Government programs - Burglar Beware, Neighbourhood Watch, Eyes on the Street, Goodbye Graffiti.	Burst of Goodbye Graffiti campaign in January. Neighbourhood Watch need re-activating.
	Promote the AFP ThinkUKnow cyber awareness safety program.	

ACTION PLAN UPDATES - FOCUS AREA THREE

Building Partnerships and Participation

Objective 3.1 Support and facilitate the Shire of Northam Community Safety Committee.

Strategies	Actions	Progress / Comments
Bi-monthly community safety meetings including a representative from the Northam Police station.	Monitor progress on Community Safety and Crime Prevention Plan.	Ongoing at meetings
	Host bi-monthly meetings.	Meetings have been occurring quarterly as per the Committee's terms of reference.

Objective 3.2 Identify and promote service providers, community groups and other key stakeholders that implement community safety and crime prevention initiatives.

Strategies	Actions	Progress / Comments
Promote all service providers, community groups and other stakeholders that offer programs aiding in crime prevention and deliver their service in the Shire of Northam.	Develop a current list of service providers and their programs and undertake a map and gap exercise to identify where gaps and/or double ups in service exist.	Information capture process started, but not completed.
	Encourage existing service providers to step into the gap.	
Establish working groups to initiate new collaborative activities to target relevant issues.	Seek internal and/or external funding assistance to assist in enabling the implementation of new community safety and crime prevention initiatives.	Ongoing.
	Encourage community ownership of places and community responses to local problems.	

ACTION PLAN UPDATES - FOCUS AREA FOUR

Community Design

Objective 4.1 Adopt and implement 'Crime Prevention Through Environmental Design' (CPTED26) principles.

Strategies	Actions	Progress / Comments
Create and implement a Designing Out Crime Plan to be completed by December 2016.	Undertake a lighting audit and install lighting in areas poorly lit and in known hotspots.	Seeking grant funding to undertake lighting audit as part of a broader CPTED audit.
	Conduct a Designing Out Crime Shire of Northam study to review current public places.	Seeking grant funding to undertake audit.
	Embed the principles of Designing Out Crime as a working practice in the planning and building responses of the Council.	CPTED Principles used in CBD Strategy and Community Plans.
	Seek funding opportunities to improve the design of the community.	Ongoing
Upgrade the community CCTV system.	Apply for funding to upgrade the CCTV system in Wundowie and Northam.	Funding granted for Wundowie system. Further funding to be sought following the completion of Wundowie.
	Install security cameras in known 'hot spots'	Shire investment in CCTV in Council facilities. Funding being sought for future public camera's.
	Apply for funding to purchase a mobile CCTV covert camera for Police use.	Ongoing
	Align the Community CCTV with the State CCTV Strategy.	Uncertainty regarding the future of the State CCTV Strategy.
Promote community participation with the State CCTV Register.	Promote the State CCTV Register to the community.	Uncertainty regarding the future of the State CCTV Strategy.
	Encourage community to register their private and business CCTV on the State CCTV Register.	
Investigate traffic calming options for Wundowie for hooning prevention.	Map problem areas and advocate for appropriate traffic calming devices for each area.	Designs drawn up. Funding not allocated in current Council budget for implementation.

Community Safety Committee Meeting Minutes
17 September 2019

5.2 REVIEW OF TERMS OF REFERENCE AND MEMBERSHIP OF THE COMMUNITY SAFETY COMMITTEE

Address:	
Owner:	Shire of Northam
Applicant:	
File Reference:	1.3.12.1
Reporting Officer:	Community Development Officer
Responsible Officer:	Executive Manager Community Services
Officer Declaration of Interest:	
Voting Requirement:	Simple majority
Press release to be issued:	No

BRIEF

The Terms of Reference for the Community Safety Committee are due to be updated following the Local Government Elections to be held in October 2019, including membership of the committee

ATTACHMENTS

Attachment 2: Draft updated Terms of Reference

BACKGROUND / DETAILS

Following Local Government Elections it is mandatory for Council and Community representation on Committees of Council to be renewed along with a Terms of Reference to be endorsed to govern the committee for the next two years.

It is proposed that in preparation for the upcoming Local Government Elections and endorsement of a new Community Safety Committee, the current Terms of Reference be reviewed to ensure that it is in keeping with the recent direction of the committee and the membership of the committee consists of representatives of key stakeholders in the area of community safety and crime prevention.

CONSIDERATIONS

Local Planning Strategy

Objective: Create an environment that provides for a caring and healthy community.

Strategy: Provide community services to uphold public safety standards.

Community Safety Committee Meeting Minutes
17 September 2019



Action: Review and implement the Shire of Northam Community Safety and Crime Prevention Plan

Financial / Resource Implications

The Shire of Northam provides administrative support to the Community Safety Committee.

Legislative Compliance

Local Government Act 1995

5.8. Establishment of committees

A local government may establish* committees of 3 or more persons to assist the council and to exercise the powers and discharge the duties of the local government that can be delegated to committees.

**Absolute majority required*

Policy Implications

Nil

Stakeholder Engagement / Consultation

Members of the Community Safety Committee will be consulted.

Risk Implications

- Reputational – Low
 - Changes to membership of the Community Safety Committee will be made in conjunction with the Committee's Terms of Reference
- Financial – Low
 - The Committee has no delegated financial responsibility
- Compliance – Low
 - The Committee and the Terms of Reference are compliant with the Local Government Act 1995, 5.8 Establishment of committees
- Legal – Low
 - There are no known legal risks

OFFICER'S COMMENT

The Committee membership outlined in the Community Safety Committee Terms of Reference 2017 – 2019 do not reflect the current attendance and contribution at Community Safety Committee meetings. The Committee has lost many members recently due the movement of staff within representative organisations. Since the last review of the Committees Terms of Reference there have also been changes to organisations working in fields relevant to community safety and crime prevention within the Shire of Northam.

With Council and Community representatives to be reviewed in October / November it is thought to be timely to review and update the Terms of Reference including organisational representation on the committee to ensure potential gaps are filled and key stakeholders working within the area of community safety and crime prevention are represented on this committee.

Community Safety Committee Meeting Minutes
17 September 2019

DISCUSSION:

- Discussion was held in relation to the changing membership of the committee on the Terms of Reference, changes are seen in red below.
- An update to the Terms of Reference was made to change the previous Alcohol and Other Drug Management Plan to the current Youth Wellbeing Plan.
- Darren Warland asked if an Aboriginal Elder could join the committee as a Community Representative. It was advised that this is something that can be looked at when nominations for community representation on the committee are called for.

RECOMMENDATION

Minute No: CSC.056

Moved: Mrs Sharon Bray

Seconded: Ms Esther Bliss

The Committee adopts the revised Terms of Reference as per Attachment 2.

CARRIED 8/0

**TERMS OF REFERENCE
SHIRE OF NORTHAM COMMUNITY SAFETY COMMITTEE**

1. Objectives of the Shire of Northam Community Safety Committee

The objective of the Shire of Northam Community Safety Committee (hereto referred to as the Committee) is to enhance community safety and reduce criminal and anti-social behaviour through a collaboration of key interests and agencies.

2. Powers of the Shire of Northam Community Safety Committee

The Committee is a formally appointed committee of Council and is responsible to that body. The Committee does not have executive powers or authority to implement actions in areas over which the Chief Executive Officer has legislative responsibility and does not have any delegated financial responsibility. The Committee does not have any management functions and cannot involve itself in management processes or procedures.

The Committee is to report to Council and provide appropriate advice and recommendations on matters relevant to its terms of reference in order to facilitate informed decision-making by Council in relation to the legislative functions and duties of the local government that have not been delegated to the Chief Executive Officer.

3. Membership

The Committee shall consist of representatives from government, non-government, police and community agencies at the local level who share a collective commitment and expertise in relation to community safety and perceptions of safety. The Committee membership may include the following:

- Two (2) Elected Members;
- Officer In Charge of the Northam Police Station or nominated representative;
- Officer In Charge of the Wundowie Police Station or nominated representative;
- One (1) representative of the Northam Roadwise Committee;
- One (1) representative of the Department of Health (Health Promotion);
- One (1) representative of the Local Drug Action Group;
- One (1) representative of the Northam Chamber of Commerce;
- One (1) representative of the Department of Education;
- One (1) representative of the Department Local Government, Sport and Cultural Industries;
- One (1) representative of the Department of Communities - Housing;
- One (1) representative of the Department of Justice;
- One (1) representative of the Department of Communities - Child Protection and Family Support
- One (1) representative of the Youth Wellbeing Plan;

Community Safety Committee Meeting Minutes
17 September 2019



- One (1) representative of **Avon Community Services**;
- One (1) representative of **PCYC**; and
- Up to two (2) community representatives.

All members have full voting rights.

4. Standing Ex-Officio Members

- Chief Executive Officer or nominated representative, i.e. Executive Manager Community Services;
- Community Development Officer
- **One (1) representative of Holyoake**
- Ranger Services **(by invitation)**
- Department of Main Roads **(by invitation)**
- Department Fire and Emergency Services **(by invitation)**

5. Meetings

The committee shall meet at least quarterly, with additional meetings convened at the discretion of the presiding member.

6. Reporting

Minutes and recommendations of each committee meeting shall be presented to the next ordinary meeting of the Council.

7. Duties and Responsibilities

The Committee will:

- Develop, review and oversee the implementation of the Shire of Northam Community Safety and Crime Prevention Plan;
- Develop, review and oversee the implementation of a **Northam Youth Wellbeing Plan**;
- Develop effective partnerships with local State Government agencies through local service agreements to support the coordination and integration of community safety and crime prevention activities within the Shire of Northam;
- Identify and coordinate funding opportunities to address priority issues that have been identified in the Community Safety and Crime Prevention Plan and the **Northam Youth Wellbeing Plan**;

8. Working Parties

Working parties may be established at the edict of this Committee to address specific issues in relation to community safety, and appoint people with the necessary knowledge and skills to contribute to those working parties.

Community Safety Committee Meeting Minutes
17 September 2019



All auxiliary working parties shall report back to the Community Safety Committee with any recommendations for action.

9. Tenure of Membership

Shall be in accordance with the Local Government Act, section 5.11, ie, until the next scheduled local government ordinary elections.

10. Committee

10.1 Chairperson

The members shall appoint the Chairperson.

10.2 Secretary

A Shire of Northam employee will fulfil the role of non-voting minute taker.

10.3 Quorum

The quorum at any meeting shall be at least 50% of the number of offices of the committee.

8.5 Voting

Shall be in accordance with the Local Government Act, Section 5.21.

8.6 Minutes

Shall be in accordance with the Local Government Act, Section 5.22.

8.7 Who Acts If No Presiding Member

Shall be in accordance with the Local Government Act, Section 5.14.

8.8 Meetings

Meetings shall be generally open to the public pursuant to Section 5.23 of the Local Government Act and include question time for members of the Committee pursuant to Section 5.24 of the Local Government Act.

8.9 Members Interests to be Disclosed

Members of the Committee are bound by the provisions of the Local Government Act Section 5.65 with respect to disclosure of financial, impartiality or proximity interests.

8.10 Code of Conduct

Members of the committee are bound by Council's Code of Conduct.

Community Safety Committee Meeting Minutes
17 September 2019

5.3 UPDATE OF NIGHT HOOPS 2019

Address:	
Owner:	Shire of Northam
Applicant:	
File Reference:	1.3.12.1
Reporting Officer:	Community Development Officer
Responsible Officer:	Executive Manager Community Services
Officer Declaration of Interest:	
Voting Requirement:	Simple majority
Press release to be issued:	No

BRIEF

To update the committee on the Night Hoops basketball program 2019.

ATTACHMENTS

Nil

BACKGROUND / DETAILS

In collaboration with Northam PCYC the Shire of Northam ran a 6 week program of Night Hoops basketball funded by the WA Police through the Community Crime Prevention Fund. The purpose of the program is to engage young people in our community between the ages of 12 – 18 who are at risk of engaging in risk taking or criminal activity.

The program ran every Saturday night between the 10th August – 14th September at the Northam Recreation Centre. Doors opened at 6.30pm for a 7pm start and finished after 10pm. At each session participants were placed into basketball teams and played a round robin tournament. Each team also rotated through a compulsory wellbeing and life-skills workshop, and were provided with a substantial evening meal & serving of fruit before being bussed home. The Wundowie Community Bus also collected young people from Wundowie & Bakers Hill.

CONSIDERATIONS

Local Planning Strategy

Objective: Create an environment that provides for a caring and healthy community.

Strategy: Provide community services to uphold public safety standards.

Action: Review and implement the Shire of Northam Community Safety and Crime Prevention Plan

Community Safety Committee Meeting Minutes
17 September 2019



Financial / Resource Implications

The Shire of Northam contributed cash and in-kind support to the Night Hoops program.

Legislative Compliance

Nil

Policy Implications

Nil

Stakeholder Engagement / Consultation

The Community Safety Committee and local youth stakeholders were consulted during the planning of Night Hoops.

Risk Implications

- Reputational – Low
 - Changes to membership of the Community Safety Committee will be made in conjunction with the Committee's Terms of Reference
- Financial – Low
 - The project primarily operated through external grant funding, with Shire contributions remaining within budget.
- Compliance – Low
 - Night Hoops 2019 was operated in compliance with Local Government requirements.
- Legal – Low
 - There were minimal legal risks.

OFFICER'S COMMENT

The 2019 program of Night Hoops basketball successfully engaged a large number of young people from Northam and surrounds, including some visitors from out of town. A high proportion of those in attendance are considered to be youth at risk, with some known to be within the justice system.

Overall behaviour and engagement throughout the program was positive.

The major issue experienced was a lack of adult helpers. This was identified as a potential risk during the planning phase and therefore it was decided to reduce the number of weeks the program ran and to use the funding to recruit paid assistance, instead of relying on volunteers. Unfortunately even through offering to pay for positions such as basketball umpires, who were offered \$120/night, we still failed to attract interest.

One of the most successful workshops conducted throughout the program was Yoga run by the Yoga Lounge. The participants reported that they didn't want this session to end and that they felt relaxed and sleepy following the workshop.

Community Safety Committee Meeting Minutes
17 September 2019



Whilst final figures and reports are still being compiled, it appears the outstanding crime statistics from 2017 did not reoccur. However, there was still some significant reduction in juvenile crime, as well as achieving outcomes in engaging youth at risk and reducing numbers of young people wandering the streets on a Saturday night.

DISCUSSION:

- Ms Hawkins provided update to the committee on the success of the 6 week Night Hoops program.
- Statistics submitted to committee by Jane Atterby (not present at meeting)
 - 130 total registrations
 - Average of 57 per night
 - 77% Aboriginal
 - 32% girls
- Police YCIO Nicky Cresswell added that 5 out of the 6 weeks there was no crime reported, the other week there were kids that had come to Night Hoops from out of town and caused trouble.
- Cr Williams questioned does the Night Hoops program have a lasting affect? YCIO Nicky Creswell responded there was progress yes, at the beginning they were quite a handful, but by the end of the program they were more appreciative and helpful.
- Ms Hawkins added that from the responses and feedback forms they received the young people look forward to the program every year.

RECOMMENDATION

Minute No: CSC.057

Moved: Mrs Sharon Bray

Seconded: Ms Esther Bliss

That the Committee accept the report of Night Hoops 2019.

CARRIED 8/0

Community Safety Committee Meeting Minutes
17 September 2019



6. GENERAL BUSINESS

6.1 AGENCY UPDATE – AGENCIES TO PROVIDE UPDATE ON THEIR SERVICE

Mr Warland updated the committee on piloting an alternative education program with the Department of Education and the schools for the disruptive children years 7-10, delivering some alternative options such as shopping, cooking, bike dismemberment. Cr Williams questioned what happens when the kids start engaging, will they stay in the program? Mr Warland responded advising that they would be put back into school or if they can, get them to do some assessments for any disabilities that may link them into the Avonvale support Education centre

7. URGENT BUSINESS APPROVED BY PERSON PRESIDING OR BY DECISION

8. DATE OF NEXT MEETING

Tuesday 17th December 2019 at 12:00pm

9. DECLARATION OF CLOSURE

There being no further business, Chairperson Cr Julie Williams declared the meeting closed at 1:20pm

"I certify that the Minutes of the Community Safety Committee meeting held on 17 September 2019 have been confirmed as a true and correct record."

_____ Chairperson

_____ Date

11.2 AUDIT COMMITTEE MEETING HELD ON 9 OCTOBER 2019

Receipt of Minutes:

<p>RECOMMENDATION / COUNCIL DECISION</p> <p>Minute No: C.3778</p> <p>Moved: Cr Antonio</p> <p>That Council receive the minutes from the Audit Committee meeting held on 9 October 2019.</p> <p style="text-align: right;">CARRIED 6/0</p>
--

Adoption of Recommendations:

<p>RECOMMENDATION / COUNCIL DECISION</p> <p>Minute No: C.3779</p> <p>Moved: Cr Antonio</p> <p>That Council:</p> <ol style="list-style-type: none">1. Receive the update as provided in the Attachment 1 in relation to the progress made towards the Better Practice Review Action Plan.2. Receive the Customer Service Audit update as provided in Attachment 1 acknowledging that all action items have been completed.3. Not require the customer service audit progress report to be provided in the future.4. Receives the update toward the Procurement Process review as provided in Attachment 1.5. Receive the update as provided in the Attachment 1 in relation to the progress made towards the following Safety & Risk Management Plan.6. Receive the update as provided in the Attachment 1 in relation to the progress made towards the Regulation 17 Action Plan.7. Receive the update as provided in Attachment 1 in relation to the progress made towards the IT Audit Review.8. Receive September 2019 Shire of Northam Risk Register update.9. Receive the update as provided in the monthly Compliance Calendar Report.10. Receive the Open Space Review and Business Improvement audit report as presented.
--

11. Receives the Australasian LG Performance Excellence Program FY18.
12. Requests that the CEO arrange a workshop to discuss the outstanding rate debt.
13. Request the CEO to present a policy to Council to manage employee annual and long service leave.
14. Receive the Financial Management Systems Review report for 2018/19 and require the progress of the recommended actions to be reported to the audit committee until all items are complete.
15. Receive the 2018/19 Interim Audit finding.

CARRIED 6/0

Attachment 1



Shire of Northam
Heritage, Commerce and Lifestyle

Shire of Northam

Minutes

Audit Committee Meeting

9 October 2019

DISCLAIMER

These minutes are yet to be dealt with by the Council. The Recommendations shown at the foot of each item have yet to be considered by the Council and are not to be interpreted as being the position of the Council. The minutes of the meeting held to discuss this agenda should be read to ascertain the decision of the Council.

In certain circumstances members of the public are not entitled to inspect material, which in the opinion of the Chief Executive Officer is confidential, and relates to a meeting or a part of a meeting that is likely to be closed to members of the public.

No responsibility whatsoever is implied or accepted by the Shire of Northam for any act, omission, statement or intimation occurring during Council or Committee meetings.

The Shire of Northam disclaims any liability for any loss whatsoever and howsoever caused arising out of reliance by any person or legal entity on any such act, omission or statement of intimation occurring during Council or Committee meetings.

Any person or legal entity who acts or fails to act in reliance upon any statement, act or omission made in a Council or Committee meeting does so at that person's or legal entity's own risk.

In particular and without derogating in any way from the broad disclaimer above, in any discussion regarding any planning application or application for a licence, any statement or intimation of approval made by any member or Officer of the Shire of Northam during the course of any meeting is not intended to be and is not taken as notice of approval from the Shire of Northam.

The Shire of Northam advises that anyone who has any application lodged with the Shire of Northam must obtain and should only rely on WRITTEN CONFIRMATION of the outcome of the application and any conditions attaching to the decision made by the Shire of Northam in respect of the application.

The Shire of Northam advises that any plans or documents contained within this agenda may be subject to copyright law provisions (*Copyright Act 1968*, as amended) and that the express permission of the copyright owner(s) should be sought prior to their reproduction. It should be noted that copyright owners are entitled to take legal action against any persons who infringe their copyright. A reproduction of material that is protected by copyright may represent a copyright infringement.

Audit Committee Meeting Minutes
9 October 2019



1. DECLARATION OF OPENING

The Shire President, Cr C R Antonio declared the meeting open at 4:00pm.

2. ATTENDANCE

Committee:

Shire President

Councillors

Cr C R Antonio

Cr A J Mencshelyi

Staff:

A/Chief Executive Officer

Executive Manager Corporate Services

Executive Assistant – CEO

Coordinator Governance / Administration

C Kleynhans

C Young

A McCall

C Greenough

2.1 APOLOGIES

Councillor

Cr J Proud

2.2 APPROVED LEAVE OF ABSENCE

Nil.

3. DISCLOSURE OF INTERESTS

Nil.

4. CONFIRMATION OF MINUTES

4.1 COMMITTEE MEETING HELD 7 MARCH 2019

RECOMMENDATION / COMMITTEE DECISION

Minute No: AU.122

Moved: Cr Antonio

Seconded: Cr Mencshelyi

That the minutes of the Audit Committee meeting held on Thursday, 7 March 2019 be confirmed as a true and correct record of that meeting.

CARRIED 2/0

Audit Committee Meeting Minutes
9 October 2019



5. COMMITTEE REPORTS

5.1 PROGRESS TOWARD BETTER PRACTICE REVIEW REPORT

Address:	N/A
Owner:	Shire of Northam
Applicant:	
File Reference:	1.6.1.6
Reporting Officer:	Jason Whiteaker, Chief Executive Officer
Responsible Officer:	Jason Whiteaker, Chief Executive Officer
Officer Declaration of Interest:	Nil
Voting Requirement:	Simple majority
Press release to be issued:	No

BRIEF

To provide Council with an update of the progress made towards the Better Practice Review (BPR) Action Plan.

This report aims to establish a level of accountability in respect to completing the actions identified through the Better Practice Review Program to ensure that continuous improvement occurs within the organisation.

ATTACHMENTS

Attachment 1: BPR Action Plan.

A. BACKGROUND / DETAILS

The Local Government BPR Program is an initiative undertaken in October 2015, with the Final Report received by Council in March 2016, by the Department of Local Government and Communities to recognise and promote good practice in Western Australian country local government. The BPR Program involved a team reviewing key areas of the Shire of Northam's activities and operations. The BPR Program objectives are to:

- Generate momentum for a culture of continuous improvement and greater compliance across the local government sector;
- Promote good governance and ethical regulation;
- Identify and share innovation and best practice in the local government sector; and
- Act as a 'health check' by providing departmental advice and support to local governments that may be experiencing operational problems.

Audit Committee Meeting Minutes
9 October 2019



The key findings from the review are summarised in the areas of Governance, Planning and Regulatory function, Plan for the Future (strategic and corporate planning), assets and finance, workforce planning / Human Resource (HR) management and community and consultation. The report aims to highlight areas where the local government is demonstrating better practice as well as providing constructive feedback on addressing any areas for further development. The areas requiring further development are provided to the local government with suggested recommendations that the local government can aim to address through a documented action plan (Attachment 1).

B. CONSIDERATIONS

B.1 Strategic Community / Corporate Business Plan

Theme 6: Governance and Leadership

Outcome 6.3 The Shire of Northam council is a sustainable, responsive, innovative and transparent organisation.

Objective: Ensure robust financial management.

B.2 Financial / Resource Implications

Staffing resources are required in order to action the recommendations detailed within the BPR Action Plan.

B.3 Legislative Compliance

Local Government Act 1995 and relevant subsidiary legislation.

B.4 Policy Implications

N/A

B.5 Stakeholder Engagement / Consultation

All senior staff were asked to review the document and make any comments.

B.6 Risk Implications

Risk Category	Description	Rating (consequence x likelihood)	Mitigation Action
Financial	Nil		
Health & Safety	Nil		
Reputation	Nil		
Service Interruption	Nil		
Compliance	Nil		
Property	Nil		
Environment	Nil		

Audit Committee Meeting Minutes
9 October 2019



C. OFFICER'S COMMENT

This review found that overall the Shire is an organisation that functions well. Areas of further development identified related to enabling planning, building and health staff to work more cohesively to deliver consistent information to the community, the improvement of asset management, financial reporting practices, meeting/briefing procedures and standing orders. Areas for further development and recommendations have been detailed in Attachment 1 with comments in respect to the progress made towards each of these.

Key to table

Completed
No Action
Underway

Officers are working towards addressing the areas for further development whilst continuing the improvements already underway in order to achieve good practice, governance and legislative compliance into the future. The action plan for the review has been provided in Attachment 1 with an update of the progress made towards the recommendations.

RECOMMENDATION / COMMITTEE DECISION

Minute No: AU.123

Moved: Cr Antonio

Seconded: Cr Mencshelyi

That Council receive the update as provided in the Attachment 1 in relation to the progress made towards the Better Practice Review Action Plan.

CARRIED 2/0

The Executive Manager Corporate Services provided an overview of the outstanding actions.

Clarification was sought in relation to whether the item will continue to be presented to the Committee once all actions are completed. The Executive Manager Corporate Services advised that it will no longer be presented.

Audit Committee Meeting Minutes
9 October 2019



Attachment 1

Area for Further Development	Recommendation / Action	Timeframe	Responsibility	Progress Report
Governance				
Business Continuity Plan	1. Continue to work towards developing a business continuity plan to complement any risk management documentation.	June 2016	CEOPA	Finalised June 2016.
Council forum meetings	2. Review the council forum procedures and formalise these to minimise duplication with Ordinary Council Meetings.	May 2016	CEO	Review completed. Notes of forums now taken and presented to council meetings for acceptance. Process has been improved eliminating duplication of agenda preparation.
Local Laws	3. Review (and update or repeal, where required) local laws, including the Standing Orders in line with the requirements of the <i>Local Government Act 1995</i>	2016/17	Gov Officer	Final Local Laws are now ready to be adopted by Council prior to Gazettal
Information Statement	4. Review and update the Shire's Information Statement and ensure that it reflects the current council.	July 2016	Gov Officer	Review completed 6/7/17. Next review 6/7/19
Legislative compliance	5. Develop a legislative compliance checklist/calendar to promote accountability and legislative awareness amongst all staff.	June 2016	CEO	In place.
Communication devices	6. Develop a communication device usage agreement for Elected Members	October 2016	CEOPA	Presented to Council 20/12/2017 and was not endorsed.
Business statement ethics	7. Consider developing a statement or policy to guide contractors and suppliers on expected standards and conduct when acting on the Shire's behalf.	August 2016	Purchasing Officer	Complete. Statement of Purchasing Ethics is incorporated into the Shire's documented purchasing process.

Audit Committee Meeting Minutes
9 October 2019



Area for Further Development	Recommendation / Action	Timeframe	Responsibility	Progress Report
Information Technology (IT) and Information and Communications Technology Framework (ICT)	8. Review the current arrangements with the Shire's IT provider to ensure appropriate support is provided.	May 2016	EMCS	Audit Carried out that resulted in the calling for quotes and a new IT provider appointed November 2018. Updated 28/02/2019.
	9. Consider the adoption of an ICT Strategic Framework as a resource to use to plan for, manage and review the Shire's information and technology assets.	November 2016	EMCS	Have realigned staff to accommodate I/T Officer to coordinate, strategies are currently being developed.
Governance Relationship	10. Review the Shire's Code of Conducts and/or develop policies to formalise and document the Shire's practices in regards to elected member and staff interactions and requests for information.	January 2017	CEO	Complete. Policy adopted.
Emergency management	11. Continue the process of reviewing and documenting emergency management processes and procedures, ensuring plans are current and relevant.	November 2016	Community Emergency Services Manager	Completion of Local Emergency Management Arrangements adopted by Council 16/11/16.
Planning and Regulatory				
Documentation on Development Application Process	12. Review the current information and content on the Shire's website relating to Planning to ensure it is accurate and helpful.	October 2016	Manager Services Planning	Ongoing. Being reviewed from time to time to ensure info and forms remain current.
	13. Further develop additional information that will assist applicants to understand the Development Applications process and ensure its availability on the Shire's website.	October 2016	Manager Services Planning	Complete April 2017.
Heritage	14. Continue working towards developing a heritage list and revising and amending the Municipal inventory.	February 2017	Manager Services Planning	Draft Heritage List presented to Council in mid-2019- final list to be presented to Council October/November 2019.

Audit Committee Meeting Minutes
9 October 2019



Area for Further Development	Recommendation / Action	Timeframe	Responsibility	Progress Report
Plan for the Future				
Corporate Business Plan	15. Ensure the annual review of the Corporate Business Plan results in the development of an evolving and rolling four-year plan, with the current financial year as the base year, which is linked to the annual budget.	May 2016	CEO	Completed.
	16. Review and provide clearer descriptions of the two categories of 'priority projects' in the Corporate Business Plan and ensure the financial allocation for the priority projects in the Corporate Business Plan aligns with the annual budget.	May 2016	CEO	Completed.
Asset and Finance				
Asset management	17. Continue the process of drafting individual asset plans for each of the major asset classes ensuring integration with other IPR plans.	June 2016	EMES	Infrastructure Asset Plan finalised. More detailed Parks & Building Asset Plans under development
	18. As part of the Shire's asset management review, both an asset management policy and strategy should be developed.	June 2016	EMES	Completed.
	19. Consider developing an asset disposal policy.	November 2016	EMCS	Asset disposal policy was adopted at OMC on April 2019
Long Term Financial Plan	20. Continue the process of revising the Long Term Financial Plan.	June 2016	EMCS	Completed.
	21. Once the update of the Long Term Financial Plan is complete, consider undertaking annual reviews of the plan and its projections to ensure data remains current and up-to-date, resulting in a rolling and evolving 10-year plan.	April 2017	EMCS	Plan being reviewed annually with adjustments carried out if necessary, updated 28/02/2019

Audit Committee Meeting Minutes
9 October 2019



Area for Further Development	Recommendation / Action	Timeframe	Responsibility	Progress Report
Statutory Ratios	22. Monitor the Operating Surplus Ratio and the Shire's expenditures to avoid any further deterioration of the continuing trend of decline of this ratio.	Ongoing	CEO	Ongoing, staff are currently focusing on these indicators and looking at developing strategies to improve performance as part of the development of the LTFP. In 2014 the Operating Surplus Ratio was 0.12, in 2017 this increased to 0.16. The target for this ratio is greater than 0.15.
	23. Consider reviewing the Shire's long term capital investment program to ensure asset renewal is maintained at an appropriate level with sufficient funding support.	Ongoing	CEO	Ongoing, staff are currently focusing on these indicators and looking at developing strategies to improve performance as part of the development of the LTFP. In 2014 the Asset Sustainability Ratio was 0.68, in 2017 this increased to 1.10. The target for this ratio is greater than 1.10.
	24. Consider reviewing the Shire's depreciation calculations to ensure depreciation expenses are accurate.	July 2016	EMCS	Completed, resulted in significant movements in depreciation to better reflect Council position.
Workforce Planning and HR Management				
Workforce Plan	25. Future revisions of the Workforce Plan should align with the rest of the Shire's Plan for the Future documentation, to ensure the most current Plan for the Future vision, mission statement, themes and objectives are captured.	December 2016	HRC	Workforce Plan draft finalised will be presented to Council November 2019.

Audit Committee Meeting Minutes
9 October 2019



Area for Further Development	Recommendation / Action	Timeframe	Responsibility	Progress Report
Employee surveys	26. Investigate the appropriateness of conducting an employee survey and including results from the survey in the revised Workforce Plan.	October 2016	HRC	Staff Survey completed.
<i>Community and Consultation</i>				
Tourism Plan	27. Continue the development of a local tourism plan/marketing strategy.	November 2016	EMCMS	The focus of the marketing plan has adjusted to become more a 'place / brand awareness' campaign which is under way with the READY.SET.GO
Reconciliation Action Plan (RAP)	28. Work with Reconciliation Australia to develop and adopt a Reconciliation Action Plan.	December 2016	EMCMS	Council has appointed a Reconciliation Action Plan Working Group to develop the RAP along Reconciliation Guidelines. The draft of the First stage "REFLECT" RAP is with Reconciliation Australia for review.

5.2 PROGRESS TOWARDS CUSTOMER SERVICE AUDIT

Address:	N/A
Owner:	Shire of Northam
Applicant:	N/A
File Reference:	1.6.1.6
Reporting Officer:	Cheryl Greenough Coordinator Governance / Administration
Responsible Officer:	Colin Young Executive Manager Corporate Services
Officer Declaration of Interest:	Nil.
Voting Requirement:	Simple majority
Press release to be issued:	No

BRIEF

This report provides Council with an update on the progress made towards the Customer Service Audit in order to ensure continuous improvement occurs within the organisation.

ATTACHMENTS

Attachment 1: Customer Service Audit Plan.

A. BACKGROUND / DETAILS

The Shire of Northam procured Aveling to conduct a Customer Service Management System Audit at the end of 2017 which included a review of the effectiveness of our ICS system and our Customer Service Charter. The report included an internal survey as well as an external customer survey.

Key findings of the review related to areas of recommended improvement for both ICS and the Customer Service Charter. Suggested improvements relating to the Customer Service Charter included document control and ensuring the document is easily accessible by customers.

For ICS' the recommended improvement areas included the ICS' were not closed out prior to action being taken and ensuring that the customer is kept up to date on the actions taken by staff.

B. CONSIDERATIONS

B.1 Strategic Community / Corporate Business Plan

Theme Area 6 Governance and Leadership

Outcome 6.3: The Shire of Northam council is a sustainable, responsive, innovative and transparent organisation.

Objective: Ensure robust financial management.

B.2 Financial / Resource Implications

Nil.

B.3 Legislative Compliance

Local Government Act 1995 and relevant subsidiary legislation.

B.4 Policy Implications

N/A.

B.5 Stakeholder Engagement / Consultation

Nil.

B.6 Risk Implications

Risk Category	Description	Rating (consequence x likelihood)	Mitigation Action
Financial	N/A	N/A	N/A
Health & Safety			
Reputation	Ratepayers and / or customers not satisfied with Council service	Moderate (9)	Implement recommendations of this report
Service Interruption	N/A	N/A	N/A
Compliance	N/A	N/A	N/A
Property	N/A	N/A	N/A
Environment	N/A	N/A	N/A

C. OFFICER'S COMMENT

The Customer Service Charter is a document which may have ongoing changes as the needs of the Shire grow and change. The Customer Service Charter is included as a controlled document.

A whistle-blower policy was discussed with Executive Managers who considered the matter was covered by the Public Interest Disclosure legislation and the Freedom of Information legislation which provides for confidentiality for anyone including staff who may have information of a sensitive nature they wish to report.

Audit Committee Meeting Minutes
9 October 2019



The Customer Service Charter has been made accessible at the front Administrative area and also on the television screen where there is a rolling information session which includes the customer service charter.

The process has been reviewed and changed on Promapp to ensure customers are aware of the steps taken in their ICS including the close out stage.

As all the areas of concern have been acted upon with some continually ongoing, it is recommended that this Audit be finalised.

Key to table

Completed

No Action

Underway

RECOMMENDATION / COMMITTEE DECISION

Minute No: AU.124

Moved: Cr Antonio

Seconded: Cr Mencshelyi

That Council;

1. Receive the Customer Service Audit update as provided in Attachment 1 acknowledging that all action items have been completed;
2. Not require the customer service audit progress report to be provided in the future.

CARRIED 2/0

Audit Committee Meeting Minutes
9 October 2019



Attachment 1

Commitment	2.5	17/6	Responsible Officer	Comments
3.1	Does the organisation have a customer service Code of Conduct? (WSM)	2	Customer Service Charter supplied 's an uncontrolled word document. This is written as addressing the community but there is no indication of how it is communicated to them.	GOV Officer Completed. ATV with rolling information in the Admin area has been installed.
3.2	Have you determined the external and internal issues that are relevant to your organisation's purpose and the achievement of customer satisfaction in the organisation's strategic direction? (ISO 10001 & 2)	2	Charter identifies major stakeholders and attempts to provide them with workable solutions. The main areas missing are stakeholder closeout and reporting to elected members. The elected member monthly report for October 2017 appears to be flawed closeout numbers. It shows approximately 30% of year to date requests are still not closed, but does not seem to trigger any alarm. It is also suspected that significant numbers of complaints have been closed out on the ICS system, without being actually closed. Examples of this include where a letter has been sent by Shire staff requesting action and then closed on the system, but no follow up visit to ensure that the action has been completed.	Executive Managers Weekly reporting is occurring for complaints and ICS's received. Complaints outstanding and completed over the period are monitored to ensure that complaints are not closed without actioning. Changes have been made to the Customer Requests process so that these are only allocated to one officer to ensure ownership of the complain/ICS. This reporting is ongoing and the total number of ICS's/complaints received will be monitored.
3.4	Has input been gained to identify and assess the needs of customers in the development of the Code and	2	There are no document control records for the process to indicate community consultation in the development.	GOV Officer Completed. The process has been placed in Promapp

Audit Committee Meeting Minutes
9 October 2019



	procedures? (ISO10001 6.3)				
3.5	Is the Code clear, concise and written in simple language? (ISO10001 6.4)	3.5	The customer service charter is well written and copies have been made available in the main reception area (at times), however the majority of customer responses indicated that it has not been publicized as well as it could have been. It is recommended that a shortened version be produced and displayed in a similar manner to the City of Cockburn example shown in section 11.	GOV Officer	Completed. A rolling TV selection is being considered. Copies of the document are also available in the Admin area.
Capacity	2		8/4		
3.8	Have the objectives been established at relevant departmental and individual levels with the business?	1.5	No Key Performance Indicators (KPI's) have been set to monitor the number of requests/complaints or their close out times. This should be completed as a priority after the next round of staff training.	Executive Managers	<p>KPI's have been established in the ICS Process on Promapp.</p> <p>KPI's are listed within the complaints process as follows:</p> <ul style="list-style-type: none"> Complaint Resolution - 90% of Complaints closed and determination provided within 20 working days; Complaint Acknowledgement - 100% of Complaints acknowledged within 5 working days. <p>KPI's are listed within the ICS process as follows:</p> <ul style="list-style-type: none"> ICS Closure - 90% of ICS's closed within 20 working days. ICS Acknowledgement - 100% of ICS's are acknowledged within 72 hours from receiving the ICS.
3.10	Is customer service included in the business plan? (WSM) If so, what elements of customer service do	2	While there is a customer service charter and reports are compiled for elected members and as part of the quarterly report card, there was no evidence available to suggest	Gov Officer	<p>Completed</p> <p>The Corporate Business Plan outlines the following actions:</p>

Audit Committee Meeting Minutes
9 October 2019



	you regularly monitor? (WSM)		that customer service forms part of a formal business plan. Customer service requests and closeouts are reported monthly and quarterly, but no KPI appears to exist on this data.		<ul style="list-style-type: none"> Manage customer services through use and maintenance of appropriate systems and processes. Implement Shire of Northam Customer Services Charter. Implement an organisational wide process for dealing with/responding to customer requests/complaints.
Visibility	2		7/3		
3.13	Is it relevant and responsive to customer needs? (ISO10001 4.6)	2	These issues are difficult to assess given that over 90% of customer survey respondents claimed that they had not seen it.	Gov Officer	Completed
Monitoring	2		8/4		
3.25	Are KPI results and/or other statistical measures used to review the performance of the organisation's customer service? (ISO10001 6.5 & 8.2)	2.5	An elected member monthly report and quarterly report card are produced which both include basic ICS statistics. These do not however offer any insight into long term open items or provide a performance target. As discussed previously, it was considered that a number of requests had been closed out without verification and that the statistics may not therefore show the true picture.	Executive Managers	<p>Ongoing.</p> <p>A report is provided to Councillors on a monthly basis providing the following information:</p> <ul style="list-style-type: none"> How many received How many have been closed The number outstanding <p>KPI's are listed within the complaints process as follows:</p> <ul style="list-style-type: none"> Complaint Resolution - 90% of Complaints closed and determination provided within 20 working days; Complaint Acknowledgement - 100% of Complaints acknowledged within 5 working days. <p>KPI's are listed within the ICS process as follows:</p> <ul style="list-style-type: none"> ICS Closure - 90% of ICS's closed within 20 working days. ICS Acknowledgement - 100% of ICS's are acknowledged within 72 hours from receiving the ICS.

Audit Committee Meeting Minutes
9 October 2019



					Community Satisfaction Survey was delivered on 1/7/19																																
Procedures	2.5		32/12																																		
4.14	Are complaints closed out and recorded once agreed actions are complete? (ISO10002 7.9)	2.5	As previously noted, at least some complaints appear to be closed out prematurely and without verification of work orders being completed.	Executive Managers	<p>Ongoing. Weekly reporting is occurring for complaints and ICS's received. Complaints outstanding and completed over the period are monitored to ensure that complaints are not closed without actioning. Changes have been made to the Customer Requests process so that these are only allocated to one officer to ensure ownership of the complaint/ICS. This reporting is ongoing and the total number of ICS's/complaints received is being monitored, see below chart used to track ICS's and complaints:</p> <div data-bbox="1317 758 1856 1173" data-label="Figure">  <table border="1"> <caption>Customer Requests Data (Estimated from Chart)</caption> <thead> <tr> <th>Month</th> <th>Customer Requests Closed</th> <th>Customer Requests Outstanding</th> <th>Customer Requests Received</th> </tr> </thead> <tbody> <tr> <td>Jul 2018</td> <td>150</td> <td>50</td> <td>300</td> </tr> <tr> <td>Aug 2018</td> <td>180</td> <td>50</td> <td>350</td> </tr> <tr> <td>Sep 2018</td> <td>150</td> <td>50</td> <td>320</td> </tr> <tr> <td>Oct 2018</td> <td>160</td> <td>80</td> <td>380</td> </tr> <tr> <td>Nov 2018</td> <td>160</td> <td>80</td> <td>200</td> </tr> <tr> <td>Dec 2018</td> <td>130</td> <td>80</td> <td>150</td> </tr> <tr> <td>Jan 2019</td> <td>280</td> <td>200</td> <td>320</td> </tr> </tbody> </table> </div>	Month	Customer Requests Closed	Customer Requests Outstanding	Customer Requests Received	Jul 2018	150	50	300	Aug 2018	180	50	350	Sep 2018	150	50	320	Oct 2018	160	80	380	Nov 2018	160	80	200	Dec 2018	130	80	150	Jan 2019	280	200	320
Month	Customer Requests Closed	Customer Requests Outstanding	Customer Requests Received																																		
Jul 2018	150	50	300																																		
Aug 2018	180	50	350																																		
Sep 2018	150	50	320																																		
Oct 2018	160	80	380																																		
Nov 2018	160	80	200																																		
Dec 2018	130	80	150																																		
Jan 2019	280	200	320																																		

Audit Committee Meeting Minutes
9 October 2019

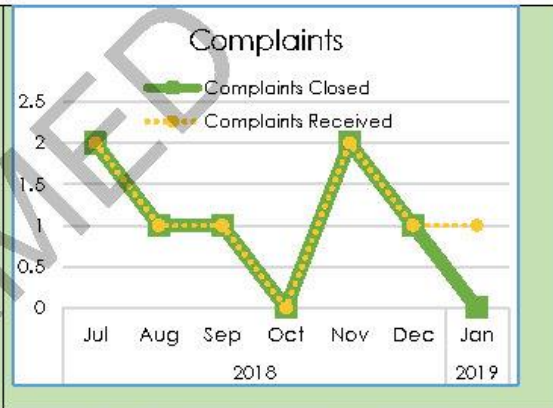

					
4.19	<p>Is complaints information, including the identity of complainants, treated confidentially wherever possible or necessary? (ISO10002 4.7)</p> <p>Are procedures are in place to manage whistle-blower complaints in accordance with the Public Interest Disclosure Act?</p>	2	<p>There was no information available to suggest that confidentiality has been considered in terms of complaints and this should be included in future updates of the process.</p> <p>No information on whistleblower complaints is included in the Shire complaints process.</p>	Executive Managers	<p>Confidentiality is always maintained in relation to customer complaints and requests. The complaints process includes details in relation to the actions to take to maintain confidentiality if the complaint is of a confidential nature and details that all elements of the complaint are to be treated with confidentiality (including the identity of the complainant).</p> <p>A Whistleblower policy was discussed with Executive Management who considered the matter was covered in the PID process and FOI process.</p>

Audit Committee Meeting Minutes
9 October 2019



4.23	Are details of reviews and actions taken to improve services published to staff and the public? (ISO10002 8.6.3)	2	The quarterly report card is circulated widely and includes ICS statistics for customer service requests (including complaints), but does not look at individual cases or outcomes. Further it does not differentiate between complaints and work requests.	Executive Managers	Process mapping system is available to all staff to ensure they are following the process for managing ICS's and complaints. Weekly reporting is now occurring to monitor the requests and complaints received. Suggested changes are to be implemented into quarterly reporting (i.e. differentiate between complaints and requests)
4.26	Does the complaints manager or coordinator compile reports for senior management based on the analysis of the data, which include recommendations for: • complaint reduction strategies, or • improvements to business processes	2.5	Reports are compiled monthly (for elected members) and quarterly (for the report card), however these are both basis numerical reports and do not provide any level of detail that would support continuous improvement in this area.	Executive Manager Corporate Services	Executive Assistant – CEO is now generating weekly reports for ICS's and complaints. Process improvements for managing complaints and ICS's are managed through Council's process mapping system which allows all staff to suggest improvements in relation to the process for managing ICS's and complaints.

5.3 PROGRESS TOWARD PROCUREMENT PROCESS REVIEW REPORT

Address:	N/A
Owner:	Shire of Northam
Applicant:	N/A
File Reference:	1.6.1.6
Reporting Officer:	Colin Young Executive Manager Corporate Services
Responsible Officer:	Colin Young Executive Manager Corporate Services
Officer Declaration of Interest:	NIL
Voting Requirement:	Simple majority
Press release to be issued:	No

BRIEF

To provide Council with an update on the progress made towards the Procurement Review Report in order to ensure that continuous improvement occurs within the organisation.

ATTACHMENTS

Attachment 1: Outcomes from the Procurement Process Review Report.

A. BACKGROUND / DETAILS

In July 2017 under the direction of the CEO, staff called for quotes from qualified business to conduct a Procurement Process Review on the Shire of Northam's purchasing policy particularly focusing on, Tenders, Records Management, Probity and Credit Card Usage.

The Audit was designed to provide both the CEO and the Council with an additional element of accountability through a check on current procurement processes, ensuring these are being adhered to by staff.

B. CONSIDERATIONS

B.1 Strategic Community / Corporate Business Plan

Theme Area 6 Governance and Leadership

Outcome 6.3 The Shire of Northam council is a sustainable, responsive, innovative and transparent organisation.

Objective: Ensure robust financial management.

Audit Committee Meeting Minutes
9 October 2019



B.2 Financial / Resource Implications

No current implications as this is an update.

B.3 Legislative Compliance

There is no legislative requirement to hold an Internal Procurement Review, however it is best practice.

B.4 Policy Implications

N/A.

B.5 Stakeholder Engagement / Consultation

All senior staff were asked to review the document and make any comments.

B.6 Risk Implications

Risk Category	Description	Rating (consequence x likelihood)	Mitigation Action
Financial	Council does not utilise rate payer funds effectively	Moderate (9)	Implement recommendations of this report
Health & Safety	N/A	N/A	N/A
Reputation	N/A	N/A	N/A
Service Interruption	N/A	N/A	N/A
Compliance	LG Act and Associated regulations are not complied with	High (12)	Implement recommendations of this report
Property	N/A	N/A	N/A
Environment	N/A	N/A	N/A

C. OFFICER'S COMMENT

On Monday 22 January 2018 Moore Stephens conducted an Audit on the Shire of Northam's Procurement processes, after the site visit follow up interviews were conducted with the Executive Management Team and the Procurement Officer.

Based on

A final report was received on 7 May 2018 that included the following contents:

1. Engagement Overview;
2. Executive Summary;
3. Summary Controls Table;
4. Review Findings and Recommendations;

Audit Committee Meeting Minutes
9 October 2019



5. Improvement Opportunities;
6. Procurement Processes – Tenders and Contracts Management;
7. Other Matters;

The major areas identified for improvement works are detailed in Attachment 1:

Key to table

Completed

No Action

Underway

RECOMMENDATION / COMMITTEE DECISION

Minute No: AU.125

Moved: Cr Antonio

Seconded: Cr Mencshelyi

That Council receives the update toward the Procurement Process review as provided in Attachment 1.

CARRIED 2/0

The Executive Manager Corporate Services provided an update in relation to the Vendor Panel software which has a \$10,000 budget allocation. It was noted that this would be purchased in the next couple of months, once this is in place this audit can be closed off.

Clarification was sought in relation to whether there were any other plumbers and electricians interested. The Acting Chief Executive Officer advised that all trades persons that staff are aware of had been approached. It was also advised that with significant purchases, information is provided to the Chamber of Commerce and circulated accordingly.

Attachment 1

REVIEW FINDINGS & RECOMMENDATIONS					
Observation	Potential Risks	Rating	Recommendation	Management Comment	Progress
<p>Per the Local Gov't (Functions and General) Regulations 1996, Part 4A, Section 24D (Discounts permitted for regional price preferences), there are three scenarios where the bid from the tenderer can be considered for a price reduction.</p> <p>The legislation allows for:</p> <ul style="list-style-type: none"> • up to 10% reduction for goods or services up to a maximum of \$50,000; • up to 5% reduction for construction (building) services up to maximum of \$50,000; or • up to 10% where the contract is for construction (building) services up to a maximum price reduction of \$500,000. <p>The Shire's Local Price Preference Policy (F 4.4), Section 3 - Local Price Preference Value, allows for a maximum price reduction of \$100,000 (excluding GST) for goods and services from within the Shire. The amount per the Shire policy does not fully align with the requirements outlined above under Section 24D.</p>	Non-alignment to Gov't Regulations.	Moderate	The Shire Local Price Preference Policy should be updated to align with the thresholds in the Regulations.	Local Price Preference Policy has been reviewed and will be presented to Council for consideration.	New Local Price Preference Policy Adopted, updated 28/02/2019

Audit Committee Meeting Minutes
9 October 2019

IMPROVEMENT OPPORTUNITIES				
ESTABLISHMENT OF PRE-QUALIFIED PANEL OF SUPPLIERS				
Observation	Potential Risks	Recommendation	Management Comment	Progress
<p>It was noted during the audit that the Shire currently does not operate any formal panels of pre-qualified suppliers. Rather, through the years, it has maintained an informal list of suppliers which it has consistently used for recurring needs such as electrical services, painting, etc. Use of an informal list may present the following limitations:</p> <ul style="list-style-type: none"> precludes consideration of other suitable service providers which are new market entrants; rates quoted by known suppliers are often not market tested; and pre-qualified panel provides greater transparency in the selection process and if implemented follows a prescribed set of rules governing how the panel will operate to manage risks and to ensure a more efficient procurement process. 	<p>The following contractors were used multiple times for the period 1 July 2017 to 31 January 2018. Examples:</p> <p><u>Plumbing Services</u></p> <ul style="list-style-type: none"> Andy's Plumbing [43 POs; spend @ \$14,000] Blackwell Plumbing [17 POs; spend @ \$15,500] <p><u>Electrical Services</u></p> <ul style="list-style-type: none"> Grafton Electrics [46 POs; \$22,000] Verlindens Electrical [4 POs; \$11,600] 	<p>It is recommended that goods and services which are:</p> <ul style="list-style-type: none"> recurring, purchased frequently throughout the year; and deemed to be low or medium procurement risk, be considered for establishment as a pre-qualified panel under Division 3 of Regulations. <p>Determination of these services could be based on spend data by service category for the past 2 or 3 years. Any services which are likely to reach \$150,000 however, must undergo a public tender process as per Section 11.</p>	<p>Staff will investigate and establish pre-qualified panels where appropriate.</p>	<p>Limited Progress staff investigating No changes – Have budgeted for vendor panel software, 3/10/2019.</p>

Audit Committee Meeting Minutes
9 October 2019

SPEND ANALYSIS				
Observation	Potential Risks	Recommendation	Management Comment	Progress
<p>Spend analysis will provide insight into current procurement arrangements and identify opportunities for strategic procurement by spend category such as assessment of sole source arrangements and the use of pre-qualified panels (refer to point 1.0 Establishment of Pre-qualified panels).</p> <p>A regular review will also contribute to the understanding of historical spend patterns and whether anticipated value for money outcomes were achieved, thus providing input into subsequent tender planning processes.</p> <p>Spend analysis will also enable the Shire to benchmark suppliers which provide similar services for the purposes of "value for money" assessment for future reference.</p>	<p>The following examples illustrate the information that was obtained through a quick analysis of spend data from 1 July 2017 to 31 January 2018:</p> <ul style="list-style-type: none"> Glenn Stuart Beveridge @ 9 months is \$91,000; this supplier could reach the \$150,000 threshold if not monitored. Several contractors provide ongoing technical services which require specialist environmental, health and safety knowledge. However, there is no contract or service agreement in place i.e. Avon Valley Contractors, Central Mobile Mechanical Repairs. Avon Valley Contractors; POs for \$8,800 for 3 months has been sole source supplier for hire of graders. 	<p>It is recommended that at least annually, a review is performed by a person independent of the Procurement function of spend by supplier, by service type and other relevant criteria to ensure that overall procurement for goods and services is a strategic activity.</p> <p>Procurement planning may also alleviate the reliance on sole source suppliers if request for goods and services on short notice is minimised.</p>	<p>Procedures will be put in place ensuring suppliers that have recurring purchases that may reach the \$150,000 tender threshold are reviewed annually.</p>	<p>Spend Analysis now being performed as part of EOFY procedures, updated 28/02/2019</p>

Audit Committee Meeting Minutes
9 October 2019



5.4 PROGRESS TOWARDS THE SAFETY & RISK MANAGEMENT PLAN

Address:	N/A
Owner:	Shire of Northam
Applicant:	
File Reference:	1.1.9.1
Reporting Officer:	Jason Whiteaker Chief Executive Officer
Responsible Officer:	Jason Whiteaker Chief Executive Officer
Officer Declaration of Interest:	NIL
Voting Requirement:	Simple majority
Press release to be issued:	No

BRIEF

To provide Council with an update of the progress made towards the Safety & Risk Management Plan.

This report aims to establish a level of accountability in respect to completing the actions identified through the audit undertaken by LGIS in 2014 and 2016 in order to ensure that continuous improvement occurs within the organisation.

ATTACHMENTS

Attachment 1: Safety & Risk Management Plan.

A. BACKGROUND / DETAILS

The AS/NZS 4801:2001 Audit Report undertaken by LGIS in August 2016 has highlighted significant improvements pertaining to all aspects of Occupational Safety and Health at the Shire of Northam. The total 'average' score for the Shire of Northam was 67% which is significantly higher than the previous audit result of 28% which was achieved in 2014.

As a consequence and to ensure that any shortfalls identified during the audit are addressed, the Safety & Risk Management Plan has been developed to ensure that required improvements are made in a timely manner. This Plan demonstrates the commitment of the Executive team together with the Occupational Safety & Health Committee to the achievement of a safe working environment.

B. CONSIDERATIONS

B.1 Strategic Community / Corporate Business Plan

Theme Area 6 Governance and Leadership

Outcome 6.3 The Shire of Northam council is a sustainable, responsive, innovative and transparent organisation.

Objective: Ensure robust financial management.

B.2 Financial / Resource Implications

Staffing resources are required in order to action the recommendations detailed within the BPR Action Plan.

B.3 Legislative Compliance

Local Government Act 1995 and relevant subsidiary legislation.

Occupation Safety & Health Act 1984 and relevant subsidiary legislation.

B.4 Policy Implications

N/A

B.5 Stakeholder Engagement / Consultation

Nil

B.6 Risk Implications

Risk Category	Description	Rating (consequence x likelihood)	Mitigation Action
Financial	Nil		
Health & Safety	Inadequate safety management systems in place due to non-completion of identified actions.	Low (1)	Monitoring the progress towards the actions which are regularly reported to the Audit Committee.
Reputation	Nil		
Service Interruption	Nil		
Compliance	Nil		
Property	Nil		
Environment	Nil		

C. OFFICER'S COMMENT

The Shire, as an employer, must ensure that all employees and contractors across the entire scope of operations are considered and included in the application of occupational health and safety management systems.

As with all system based programs there is opportunity for continuous improvement aligned with AS/NZS 4801 guidance specifications. The implementation of the recommendations contained in audit report have

Audit Committee Meeting Minutes
9 October 2019



assisted the Shire of Northam to improve its current occupational health and safety performance.

Officers are working towards addressing the areas requiring attention whilst continuing the improvements already underway in order meet its occupational health and safety responsibilities into the future. The Safety & Risk Management Plan has been provided as Attachment 1 with an update of the progress made towards the actions.

Key to table

Completed
No Action
Underway

RECOMMENDATION / COMMITTEE DECISION

Minute No: AU.126

Moved: Cr Antonio

Seconded: Cr Mencshelyi

That Council receive the update as provided in the Attachment 1 in relation to the progress made towards the following Safety & Risk Management Plan.

CARRIED 2/0

The Executive Manager of Corporate Services advised that the action regarding contractors and safety practices was still open. Left open until appropriate action has been completed. Significant tenders already have safety practices considered, plus all local contractors have been inducted.

Audit Committee Meeting Minutes
9 October 2019



Attachment 1

Action Item	Element Number	Sub-element Number	Score	Requirements Extracted From Criteria	Actions to be Taken	Responsibility	Due Date
1	OSH Audit 2014	N/A	N/A		Close out actions from OHS Audit 2014 HR to note item as superseded by 2016 Audit	HR	31.3.17 ACTIONED
2	4.3	4.3.1	3	<p>Planning Identification of Hazards, Hazard/Risk Assessment and Control of Hazards/Risks <i>The organisation shall establish, implement and maintain documented procedures for hazard identification, hazard/risk assessment and control of hazards/risks of activities, products and services over which an organisation has control or influence, including activities, products or services of contractors and suppliers.</i></p> <p><i>The organisation shall develop its methodology for hazard identification, hazard/risk assessment and control of hazards/risks, based on its operational experience and its commitment to eliminate workplace illness and injury. The methodology shall be kept up to date.</i></p>	Contractor management procedure to be developed and implemented to include hazard identification for contracts less than \$100K.	HR	Completed, currently being reviewed by Executive team
3	4.3	4.3.2	2	<p>Legal and Other Requirements <i>The organisation shall establish, implement and maintain procedures to identify and have access to all legal and other requirements that are directly applicable to the OSH issues related to its activities, products or services, including relevant relationships with contractors and suppliers. The organisation shall keep this information up-to-date. It shall communicate relevant information on legal and other requirements to its employees.</i></p>	Develop a procedure for accessing legislative documentation e.g. Act, Regulations, Codes of Practice, Australian Standards etc.	HR	31.3.17 COMPLETED
4	4.3	4.3.3	3	<p>Objectives and Targets</p>	Ensure that targets align with all Shire Business	HR	ONGOING

Audit Committee Meeting Minutes
9 October 2019



Action Item	Element Number	Sub-element Number	Score	Requirements Extracted From Criteria	Actions to be Taken	Responsibility	Due Date
				<i>The organisation shall establish, implement and maintain documented OHS objectives and targets, at each relevant function and level within the organisation. When establishing and reviewing its objectives, an organisation shall consider its legal and other requirements, its hazards and risks, its technological options, its operational and business requirements and the views of interested parties. The objectives and targets shall be consistent with the OSH policy, including the commitment to measuring and improving OSH performance.</i>	Plans and documents e.g. LTIFR targets		
5	4.3	4.3.4	2	<p>OHS Management Plans</p> <p><i>The organisation shall establish and maintain management plans for achieving objectives and targets. They shall include:</i></p> <p>a) <i>Designation of responsibility for achievement of objectives and targets at relevant functions and levels of the organisation;</i></p> <p>b) <i>Outlining the means and timeframes by which objectives and targets are to be achieved.</i></p> <p><i>Procedures shall be established to ensure that current plans are reviewed and if necessary amended to address such changes at regular and planned intervals, whenever there are changes to the activities, products or services of the organisation or significant changes in operating conditions.</i></p>	Ensure any OHS Management Plans (Safety and Risk Management Plans are regularly reviewed and updated.	OSH COMMITTEE	ONGOING TO BECOME A REGULAR ITEM ON AGENDA
6	4.4	4.4.1.2	2	<p>Responsibility and Accountability</p> <p><i>The organisation shall define, document and communicate the areas of accountability and responsibility (including those imposed by OHS legislation). Where contractors are involved, those areas of accountability and responsibility shall be clarified with respect to those contractors.</i></p>	Performance evaluations need to include OHS. Position descriptions should include a sign-off of OHS responsibilities. Any amendments made to	EXECUTIVE TEAM	All PD's and performance appraisals include OSH

Audit Committee Meeting Minutes
9 October 2019



Action Item	Element Number	Sub-element Number	Score	Requirements Extracted From Criteria	Actions to be Taken	Responsibility	Due Date
				a) <i>The organisation's top management shall appoint a specific management representative(s) who, irrespective of other responsibilities, shall have defined roles, responsibilities and authority for:</i> a) <i>ensuring that OHSMS requirements are established, implemented and maintained in accordance with AS/NZS 4801; and</i> b) <i>reporting on the performance of the OHSMS to top management for review and as a basis for improvement of the OHSMS.</i>	performance evaluations and/or Position Descriptions need to be communicated to relevant personnel.		
7	4.4	4.4.2	3	Training and Competency <i>The organisation in consultation with employees shall identify training needs in relation to performing work activities competently, including OHS training. Procedures shall be in place to ensure that OHS competencies are developed and maintained. Personnel shall be assessed as competent on the basis of skills achieved through education, training or experience, to perform assigned tasks taking into account the OHS obligations, hazards and risks associated with the work activities.</i>	Training requirements should be clearly stated in Position Descriptions.	EXECUTIVE TEAM & HR	Exercise ongoing, updating Position descriptions based on information received at appraisal
8	4.4	4.4.2	2	Training and Competency Continued <i>Procedures shall be developed for providing OHS training. These procedures shall take into account:</i> a) <i>the characteristics and composition of the workforce which impact on occupational health and safety management; and</i> b) <i>responsibilities, hazards and risks.</i> <i>The organisation shall ensure that all personnel, including contractors and visitors, have undertaken training appropriate to the identified needs.</i> <i>Training shall</i>	Develop a procedure that outlines the specific training requirements for OHS including Contractors.	HR	Training Plan created through CRTAFE.

Audit Committee Meeting Minutes
9 October 2019



Action Item	Element Number	Sub-element Number	Score	Requirements Extracted From Criteria	Actions to be Taken	Responsibility	Due Date
				<i>be carried out by persons with appropriate knowledge, skills and experience in OHS and training.</i>			
9	4.4.3	4.4.3.2	3	<p>Communication</p> <p><i>The organisation shall have procedures for ensuring that pertinent OHS information is communicated to and from employees and other interested parties.</i></p>	All staff meetings and toolbox meetings must be documented and OHS items raised must be minuted.	DEPARTMENT MANAGERS	31.3.17 & ONGOING
10	4.4.3	4.4.3.3	3	<p>Reporting</p> <p><i>a) Appropriate procedures for relevant and timely reporting of information shall be established to ensure the OHSMS is monitored and performance improved. Reporting procedures shall be established to cover the following:</i></p> <p><i>a) OHS performance reporting (including results of OHS audits and reviews)</i></p> <p><i>b) Reporting on incidents and systems failures</i></p> <p><i>c) Reporting on hazard identifications</i></p> <p><i>a) Reporting on hazard/risk assessment</i></p> <p><i>e) Reporting on preventive and corrective action</i></p> <p><i>f) Statutory reporting requirements</i></p>	Include reporting notification timeframes in the OHS induction (for employees and contractors).	HR	31.3.17 COMPLETED
11	4.4	4.4.5	2	<p>Document and Data Control</p> <p><i>The organisation shall establish, implement and maintain procedures for controlling all relevant documents and data required by AS/NZS 4801 to ensure that:</i></p> <p><i>a) They can be readily located;</i></p> <p><i>b) They are periodically reviewed, revised as necessary and approved for adequacy by competent and responsible personnel;</i></p> <p><i>c) Current versions of relevant documents and data are available at all locations where</i></p>	Finalise Document Control and Records Management Procedure (see previous OHS Audit 2014 actions).	EXECUTIVE MANAGER CORPORATE SERVICES	Completed and registered in Promapp

Audit Committee Meeting Minutes
9 October 2019



Action Item	Element Number	Sub-element Number	Score	Requirements Extracted From Criteria	Actions to be Taken	Responsibility	Due Date
				<p>operations essential to the effective functioning of the OHSMS are performed;</p> <p>a) Obsolete documents are promptly removed from all points of issue or otherwise assured against unintended use; and</p> <p>e) Archival documents and data retained for legal or knowledge preservation purposes or both, are suitably identified.</p> <p>Documentation and data shall be legible, dated (with dates of revision) and readily identifiable and be maintained in an orderly manner for a specified period. Procedures and responsibilities shall be established and maintained concerning the creation and modification of various types of documentation and data. The organisation shall preclude the use of obsolete documents.</p>			
12	4.4.6	4.4.6.1	2	<p>General</p> <p>The organisation shall establish, implement and maintain documented procedures to ensure that the following are conducted:</p> <p>hazard identification; hazard/risk assessment; of hazards/risks; and then evaluation of steps a) to c).</p>	<p>Evaluate current Hazard Management Procedure for effectiveness and continual improvement.</p> <p>(Chiara will develop evaluation methodology and a template for reporting on this).</p> <p>Develop and implement a purchasing procedure & Hire/Lease procedure/Agreement that details hazard identification, risk assessment and risk control of new products</p>	<p>HR</p> <p>EXECUTIVE MANGER CORPORATE SERVICES</p>	<p>Ongoing evaluation at OSH Committee meetings</p> <p>Statement of Purchasing Ethics Completed</p>

Audit Committee Meeting Minutes
9 October 2019



Action Item	Element Number	Sub-element Number	Score	Requirements Extracted From Criteria	Actions to be Taken	Responsibility	Due Date
					Implement a Supplier/Contractor selection criteria and listing based on safety practices	EXECUTIVE MANGER CORPORATE SERVICE	Limited progress
13	4.4.6	4.4.6.2	2	Hazard Identification a) <i>The identification of hazards in the workplace shall take into account:</i> a) <i>the situation or events or combination of circumstances that has the potential to give rise to injury or illness;</i> b) <i>the nature of the potential relevant injury or illness.</i> i. <i>The identification process shall also include consideration of:</i> i. <i>the way that work is organised, managed, carried out and any changes that occur in this;</i> ii. <i>the design of workplaces, work processes, materials, plant and equipment;</i> iii. <i>the fabrication, installation and commissioning and handling and disposal (of materials, workplaces, plant and equipment);</i> iv. <i>the purchasing of goods and services;</i> v. <i>the contracting and subcontracting of plant, equipment, services and labour including contract specification and responsibilities to and by contractors;</i> vi. <i>vi) the inspection, maintenance, testing, repair and replacement (of plant and equipment) to the activity, product or service; and</i> c) <i>past injuries, incidents and illnesses.</i>	Conduct a review of injury, hazard and incident data. Analyse and consider findings in data for planning future work. Chiara will develop a methodology and template for reporting on this.	OSH COMMITTEE	ONGOING
14	4.4.6	4.4.6.3	3	Hazard/Risk Assessment	Develop a Job Safety Analysis template that is	HR	30.11.16 COMPLETED

Audit Committee Meeting Minutes
9 October 2019



Action Item	Element Number	Sub-element Number	Score	Requirements Extracted From Criteria	Actions to be Taken	Responsibility	Due Date
				<i>All risks shall be assessed and have control priorities assigned, based on the established level of risk.</i>	consistent throughout the Shire departments ensuring that the template includes an initial risk rating and residual risk rating boxes. It is recommended that the document called "Task Steps" be re-named "Safe Work Method Statement" to align with the OHS legislation.		
15	4.4.6	4.4.6.5	2	Evaluation <i>The process of hazard identification, hazard/risk assessment and control of hazards/risks shall be subject to a documented evaluation of effectiveness and modified as necessary.</i>	As above for 4.4.6.1.	HR	31.1.18 Evaluated on a regular basis at OSH Committee meetings
16	4.5.1	4.5.1.2	2	General continued <i>The organisation shall establish, implement and maintain documented procedures to monitor and measure on a regular basis the key characteristics of its operations and activities that can cause illness and injury. The effectiveness of these measures shall be evaluated. Appropriate equipment for monitoring and measurement related to health and safety risks shall be identified, calibrated, maintained and stored as necessary.</i> <i>Records of this process shall be retained according to the organisation's procedures.</i>	Conduct a risk assessment to determine health surveillance requirements. This includes reviewing MSDS' and work processes. Chiara will assist with this process. When it is determined whether health surveillance is required a	HR	31.1.18 Evaluated on a regular basis at OSH Committee meetings

Audit Committee Meeting Minutes
9 October 2019



Action Item	Element Number	Sub-element Number	Score	Requirements Extracted From Criteria	Actions to be Taken	Responsibility	Due Date
				<p>With regards to the OHSMS, the organisation shall establish, implement and maintain procedures to monitor:</p> <ul style="list-style-type: none"> a) performance, effectiveness of operational controls and conformance with the organisation's objectives and targets; and b) compliance with relevant OHS legislation. 	procedure should be developed.		
17	4.5	4.5.3	2	<p>Records and Records Management</p> <p>The organisation shall establish, implement and maintain procedures for the identification, maintenance and disposition of OHS records, as well as the results of audits and reviews. OHS records shall be legible, identifiable and traceable to the activity, product or service involved. OHS records shall be stored and maintained in such a way that they are readily retrievable and protected against damage, deterioration or loss. Their retention times shall be established and maintained. Records shall be maintained as appropriate to the system and to the organisation, to demonstrate conformance to the requirements of AS/NZS 4801.</p>	<p>As above for 4.4.5.</p> <p>Review current staff access, security arrangements and storage of records.</p>	EXECUTIVE MANAGER CORPORATE SERVICES	Completed and registered in Promapp. A secure area has been arranged for OHS records in the Records Office
18	4.5	4.5.4	1	<p>OHSMS Audit</p> <p>The organisation shall establish, implement and maintain an audit program and procedures for periodic audits to be carried out by a competent person, in order to:</p> <ul style="list-style-type: none"> a) determine whether the OHSMS: <ul style="list-style-type: none"> i) conforms to planned arrangements for OHS management including the requirements of AS/NZS 4801; ii) has been properly implemented and maintained; iii) is effective in meeting the organisation's policy as well as objectives and targets for continual improvement; and 	<p>Develop a procedure for audits.</p> <p>Develop an Audit Program based on previous audit findings and areas of concern.</p>	HR	<p>30.6.17</p> <p>Completed</p>

Audit Committee Meeting Minutes
9 October 2019



Action Item	Element Number	Sub-element Number	Score	Requirements Extracted From Criteria	Actions to be Taken	Responsibility	Due Date
				<p>ii) provide information on the results of audits to management and employees.</p> <p>The audit program, including any schedule, shall be based on the OHS importance of the activity concerned, and the results of previous audits. The audit procedures shall cover scope, frequency, methodologies and competencies, as well as the responsibilities and requirements for conducting audits and reporting results.</p>			
19	4.6	4.6	2	<p>Management Review</p> <p>The organisation's top management shall ensure, at intervals that it determines, review the OHSMS, to ensure its continuing suitability, adequacy and effectiveness. The management review process shall ensure that the necessary information is collected to allow management to carry out this evaluation. This review shall be documented. Management shall review the continued relevance of, and change where appropriate, policy, objectives, responsibilities and other elements of the OHSMS, in light of OHSMS audit results, changing circumstances and the commitment to continual improvement.</p>	<p>Senior management to conduct a review of the OHS system.</p> <p>Develop an agenda for items and determine timeframes/intervals for the review.</p>	EXECUTIVE TEAM	<p>Executive Have standing agenda item in fortnightly meeting to discuss progress of OHS, the OHS system is constantly under review. Currently assessing a change in OHS software</p>

5.5 PROGRESS TOWARDS THE REGULATION 17 REVIEW ACTION PLAN

Address:	N/A
Owner:	Shire of Northam
Applicant:	N/A
File Reference:	8.2.7.1
Reporting Officer:	Jason Whiteaker, Chief Executive Officer
Responsible Officer:	Jason Whiteaker, Chief Executive Officer
Officer Declaration of Interest:	Nil
Voting Requirement:	Simple majority
Press release to be issued:	No

BRIEF

To provide Council with an update of the progress made towards the Regulation 17 Review Action Plan.

This report aims to establish a level of accountability in respect to completing the actions identified through the Regulation 17 Review to ensure that Council's risk management, internal controls and legislative compliance is appropriate and effective.

ATTACHMENTS

Attachment 1: Regulation 17 Review Action Plan. Appendix A, B, & C

A. BACKGROUND / DETAILS

The Shire of Northam procured AMD Chartered Accountants to undertake the Shire of Northam's Regulation 17 Review in accordance with Local Government (Audit) Regulations 1996, Regulation 17 for the period ending 31 December 2016. This Regulation 17 Review includes a review of the appropriateness and effectiveness of the risk management, internal controls and legislative compliance of the Shire of Northam. A report has then been prepared identifying the findings from the review along with recommendations (if applicable). These findings and recommendation have been developed into an action plan and provided in Attachment 1.

B. CONSIDERATIONS

B.1 Strategic Community / Corporate Business Plan
Theme Area 6 Governance and Leadership

Audit Committee Meeting Minutes
9 October 2019



Outcome 6.3 The Shire of Northam council is a sustainable, responsive, innovative and transparent organisation.
Objective: Ensure robust financial management.

B.2 Financial / Resource Implications

Staffing resources are required in order to action the recommendations detailed within the BPR Action Plan.

B.3 Legislative Compliance

Local Government Act 1995 and relevant subsidiary legislation.

B.4 Policy Implications

N/A

B.5 Stakeholder Engagement / Consultation

All senior staff were asked to review the document and make any comments.

B.6 Risk Implications

Risk Category	Description	Rating (consequence x likelihood)	Mitigation Action
Financial	Nil		
Health & Safety	Nil		
Reputation	Nil		
Service Interruption	Nil		
Compliance	Inadequate compliance measures in place due to non-completion of identified actions.	Low (1)	Monitoring the progress towards the actions which are regularly reported to the Audit Committee.
Property	Nil		
Environment	Nil		

C. OFFICER'S COMMENT

This review indicated that the Shire of Northam is proactive in managing risk, internal controls and legislative compliance as well as taking the necessary steps to ensure appropriate risk management, internal controls and legislative compliance policies and practices are in place. Areas for improvement and recommendations have been detailed in Attachment 2 with comments in respect to the progress made towards each of these.

Audit Committee Meeting Minutes
9 October 2019



Officers are working towards addressing the recommendations from the review whilst continuing the improvements already underway in order to achieve an optimum levels of risk management, internal controls and legislative compliance into the future. The Action Plan for Review has been provided in Attachment 1 with an update of the progress made towards the recommendations.

Key to table

Completed
No Action
Underway

RECOMMENDATION / COMMITTEE DECISION

Minute No: AU.127

Moved: Cr Antonio

Seconded: Cr Mencshelyi

That Council receive the update as provided in the Attachment 1 in relation to the progress made towards the Regulation 17 Action Plan.

CARRIED 2/0

Clarification was sought in relation to the reference to 2016 in the Background/Detail of the report. The Executive Manager Corporate Services confirmed this is correct and advised that it is due again this calendar year. It is a statutory requirement for this to be completed every 3 calendar years.

It was noted that the Risk Policy has now been adopted by Council.

Attachment 1

APPENDIX A
SHIRE OF NORTHAM
RISK MANAGEMENT

No.	Finding	Finding Rating	Implication	Recommendation	Management Comment	Responsible Officer	Progress to Date
1	<p>Shire of Northam have not developed an organisational-wide risk register which identifies risks, assesses the impact of the risk and identifies controls to mitigate risk.</p> <p>We would expect the organisational risk register to encompass each business unit incorporating the following categories for each business unit:</p> <ul style="list-style-type: none"> Operational; Strategic; Finance; Technological; and Compliance risks (also refer Appendix C) <p>While we acknowledge Shire of Northam has developed a Risk Management Framework, Risk Dashboard and many individual policies and operational procedures,</p>	Medium	Lack of documentation in place to evidence risks have been identified.	<p>We recommend the Shire of Northam develop an organisational risk register. This should include conducting a comprehensive risk identification process to identify potential Shire of Northam risks within each business unit and incorporating the following categories:</p> <ul style="list-style-type: none"> (a) Operational; (b) Strategic; (c) Finance; (d) Technological; and (e) Compliance risks. <p>The risk register should identify the risk, analyse the risk by determining the likelihood, consequence and current controls in respect to each identified risk; evaluate the risk by deciding whether the risk is to be treated/controlled,</p>	<p>A current register exists even though it is not as extensive as that suggested, the risk register will be updated in the future as recommended.</p> <p>Agree, the three identified policies will be developed.</p>	Chief Executive Officer	Detailed risk register has been completed and is populated within Promapps

Audit Committee Meeting Minutes
9 October 2019



No.	Finding	Finding Rating	Implication	Recommendation	Management Comment	Responsible Officer	Progress to Date
	<p>the risk identification process is the first step to effective risk management.</p> <p>In addition, we noted Shire of Northam's Risk policies and procedures do not include:</p> <p>(a) Litigation/Claims Policy;</p> <p>(b) Fraud Control Policy; and</p> <p>(c) Whistleblower/Public Interest Disclosure (PID) Policy (allowing anonymous reporting and to be available on the Shire's website to ensure external parties can report).</p>			<p>reassessed or accepted and determine the action to be taken to treat or control each risk.</p> <p>The risk register should also be monitored and reviewed on a regular basis to ensure up to date and integrates with existing Shire of Northam Risk Management Framework policies and procedures.</p>			
2	<p>We noted at the time of our on-site visit the following plans are currently under review and require finalisation:</p> <p>(a) Landfill Site Waste Management Plan;</p> <p>(b) Local Emergency Response Plan;</p> <p>(c) Bushfire Management Plan;</p> <p>(d) Asset Management Plan; and</p> <p>(e) Long Term Financial Management Plan.</p>	Medium	<p>Risk of significant delays and business interruption in the event of unforeseen circumstances in respect to Northam Community and District operations.</p> <p>Risk of the plan being out of date and non-compliance with the plan.</p>	<p>Once the plans have been completed, we recommend they are endorsed and communicated to all staff, implemented and monitored on a regular basis including testing the plans to ensure that in the event of a disaster, appropriate actions can be taken.</p>	<p>Noted, all plans are expected to be finalized and adopted early 2017, current plans in place reduce the risk until the reviews are completed.</p>	<p>Various</p> <p>CESM</p>	<p>A – Inkpen Road Waste Management Facility Plan was adopted by Council on 25.01.2017. The Old Quarry Road Waste Management was endorsed by Council on 17/05/2017.</p> <p>B – Completion of Local Emergency Management Arrangements adopted by Council 16/11/16.</p> <p>C – Bush Fire Manual was endorsed by Council on 19/09/2018</p>

Audit Committee Meeting Minutes
9 October 2019



No.	Finding	Finding Rating	Implication	Recommendation	Management Comment	Responsible Officer	Progress to Date
							D – Completed for road related assets, finalising parks & buildings currently E – Completed
3	<p>We noted that the following from the sample of lease agreements tested:</p> <p>(a) Lease agreement for Northam Aero Club Management is not signed and the details on the lease register are out of the date;</p> <p>(b) Lease register not updated to reflect the lease agreement terms for Northam Airport – Hanger 13; and</p> <p>(c) The commencement date in the lease register for Blackberry Close Bakers Hill differs to that reflected in the lease agreement.</p>	Medium	Risk the Shire is exposed to risks due to lessee non-compliance with lease terms.	We recommend a sample lessee compliance check be completed to ensure lessees are complying with stated lease terms, including obtaining documentation to support adequate insurance is maintained by the lessee. This could be completed on a rolling basis over several years to ensure all lessees are contacted at least once within the lease term.	<p>(a) As discussed with the Auditor, the lease agreement for Northam Aero Club is not yet signed because it is with them (Aero Club) for their approval and signing.</p> <p>(b) Register for Hangar 13 has been updated.</p> <p>(c) The reason is that the original lease commenced in 2004 and went for 5 years, a new lease was initiated 1/7/2009 for two years with 4x2year options to renew. The lease register is currently being updated so this will be rectified.</p> <p>The Governance officer is the designated officer with the responsibility for ensuring compliance and random checks are done several times a year to ensure compliance.</p>	Governance Officer	Completed

Audit Committee Meeting Minutes
9 October 2019



No.	Finding	Finding Rating	Implication	Recommendation	Management Comment	Responsible Officer	Progress to Date
4	<p>While the "Declaration of Interest" step was added to the Purchasing Process in Promapp post the Projects and Contracts Administration Officer and Procurement Officer attending the WALGA procurement training in August 2016, there is no centrally maintained register that records any disclosed Councillor and staff conflicts of interests.</p> <p>We acknowledge the Shire of Northam records those interests disclosed at the Council and Committee meetings in the Register of Financial Interest. However this register does not currently record any conflicts (whether perceived or actual) disclosed outside these meetings.</p>	Medium	<p>Risk that a Councillor/staff have a perceived/actual conflict of interest which is not recorded and managed appropriately by the Council.</p>	<p>We recommend that the Shire of Northam design and implement a conflict of interest register. This register should be monitored to ensure that all conflicts (whether perceived/actual) are disclosed. All conflicts of interest should be managed accordingly by the Shire.</p>	<p>Noted, management will investigate the establishment of a central register</p>	CEO	<p>Executive Assistant – CEO (EA – CEO) has posted an improvement idea/request onto the 'Manage Purchasing' process for an additional task outlining that a disclosure of interest form is to be completed (if applicable) and forwarded the EA – CEO. This will then be added to the existing Register for Interest Disclosures. This improvement idea/request is currently pending approval of the process owner (Executive Manager Corporate Services). The EA – CEO has also amended the register to add an additional field for the person/party/location which the disclosure relates to allow for a quick search to be undertaken when reviewing whether interests should be declared.</p>

Audit Committee Meeting Minutes
9 October 2019



No.	Finding	Finding Rating	Implication	Recommendation	Management Comment	Responsible Officer	Progress to Date
5	Our inquiries of the Human Resources Officer identified that the Shire of Northam does not maintain a central Contractor/Sub-contractor Insurance Register and that the responsibility for checking insurances currently rests with the Responsible Officer who has arranged the Contract.	Medium	Risk that the Contractors/Sub-contractors insurances expire whilst providing the service to the Shire and that this is not identified in a timely manner.	We recommend that the Shire designs and implements a central Contractor/Sub-contractor Insurance Register which is maintained by one or two individual to ensure that all insurances are up to date.	Noted and will implement.	Human Resource Officer	Central contractor/sub contractor insurance register created and will be maintained by Engineering Services.
6	Our inquiries indicated Shire of Northam has no documented policy or procedure in respect to personally owned IT devices including laptops, smartphones, tablets, thumb drives etc.	Medium	Risk that existing procedures and practices in respect to personally owned devices are not formally documented.	In accordance with the Department of Local Government IT Framework (best practice guidelines), we recommend policies and procedures outlining the terms and conditions in respect to the use of personally owned devices and access be documented, approved, implemented and monitored on an ongoing basis.	Noted, a policy will be developed and implemented.	Exec Manager Corporate Services	Limited, policy to be developed as part of overall IT Strategy.

Audit Committee Meeting Minutes
9 October 2019



No.	Finding	Finding Rating	Implication	Recommendation	Management Comment	Responsible Officer	Progress to Date
7	While our inquiries indicate that the Shire of Northam's prior period Audit Regulation 17 Risk Report (being the risk dashboard) was presented to the Audit Committee, an updated risk report is not provided to the Audit Committee / Council on a regular basis.	Low	Lack of communication with those charged with governance.	Once the development of the organisation risk register (as noted at number 1 above) is completed, we recommend this register and / or risk dashboard is tabled at Audit Committee and subsequent Council meetings on a periodic basis.	Notes, currently in the process of reviewing the functions for the Audit committee.	CEO	Completed, per this report to the Audit Committee.
8	We note Shire of Northam does not currently hold Cybercrime insurance.	Low	Risk of being uninsured against cybercrime.	We recommend Council investigate obtaining cybercrime insurance.	Insurance coverage is reviewed annually in consultation with the council Insurance Company (LGIS), in the past this has not been identified as a 'high' risk area, will investigate as part of the annual insurance review.	Exec Manager Corporate Services	Complete – The Shire now has cover for Cybercrime.

Audit Committee Meeting Minutes
9 October 2019



No.	Finding	Finding Rating	Implication	Recommendation	Management Comment	Responsible Officer	Progress to Date
9	We noted the Shire of Northam Insurance Register does not currently record the date insurance claims are submitted to the Shire of Northam, to ensure insurance claims are subsequently lodged and followed up in a timely manner after an incident.	Low	Untimely recovery of costs associated with insurance events.	We recommend insurance claims be lodged on a timely basis after incidents occur (we suggest no longer than one month) and the date the claim is submitted to the Shire be recorded in the insurance claims register.	Noted.	Governance Officer	Completed August 2018
10	Our review identified that the: (a) Community Engagement Plan was last endorsed on 12 October 2011; and (b) Management of Council Property Leases was last reviewed on 16 October 2013.	Low	Risk that outdated documents are being referenced by Council staff.	We recommend all Council plans, policies and procedures are reviewed and updated regularly. We also recommend that reviews of policies and procedures include ensuring all references to legislation / guidelines are current and if legislation / guidelines have changed, the policy is updated to reflect those changes.	Plans and policies are monitored and reviewed (as required) internally on a regular basis.	Various CEO Governance	a) Not yet reviewed. No change since previous update. b) Completed Endorsed by Council in August 2018.

Audit Committee Meeting Minutes
9 October 2019



No.	Finding	Finding Rating	Implication	Recommendation	Management Comment	Responsible Officer	Progress to Date
11	Our inquiries of the Executive Manager, Corporate Services indicated that there is currently no Council signature specimen list in place.	Low	Risk that someone without the appropriate delegated authority signs a document approving a Contract, transaction etc. which could be enforceable by another party.	We recommend that the Shire of Northam develops a signature specimen list for all those with delegated authority.	A signature register is currently being developed.	Exec Manager Corporate Services	Completed.
12	Our inquiries of the Projects and Contracts Administration Officer identified that Council has not developed any probity plan(s) or Statement of Purchasing Ethics requiring acknowledgement by third parties.	Low	Risk of the third party not acting in accordance with the Shire's policies and procedures.	We recommend that the Shire develops and implements a Statement of Purchasing Ethics which sets out the way the third party conducts business with the Shire. Terms and conditions included within supplier contracts would require suppliers to comply with Council's Statement of Purchasing Ethics.	Will investigate the implementation.	Exec Manager Corporate Services	Completed March 2018

Audit Committee Meeting Minutes
9 October 2019



No.	Finding	Finding Rating	Implication	Recommendation	Management Comment	Responsible Officer	Progress to Date
13	<p>We noted that there is currently no process documented in Promapp which covers the following:</p> <ul style="list-style-type: none"> Receiving of goods/services; Matching of purchase order to invoice; Invoice verification; and Invoice authorisation ready for payment. 	Low	Lack of a formalised documented processes.	<p>We recommend that the Shire designs and implements in Promapp an all-encompassing purchasing process which includes the following (in addition to the current Purchasing Process documented in Promapp):</p> <ul style="list-style-type: none"> Receiving of goods/services; Matching of purchase order to invoice; Invoice verification and authorisation 	Staff are currently in the process of developing a procedure with the Promapp system for creditor payments this will cover the identified areas.	Exec Manager Corporate Services	Completed November 17

**APPENDIX B
SHIRE OF NORTHAM
INTERNAL CONTROLS**

No.	Finding	Finding Rating	Implication	Recommendation	Management Comment	Responsible Officer	Progress to Date
1	Our inquiries of the Executive Manager, Corporate Services identified that the Shire of Northam does not currently have a formal documented IT Disaster Recovery Plan in place. We acknowledge that IT Disaster Recovery is briefly commented on in the Business Continuity Plan and that by coincidence the Shire put to test the recovery of the Shire's back-up due to an incident that occurred on 22 September 2016.	Medium	Risk of significant delays and business interruption in the event of unforeseen circumstances in respect to Council organisational business.	We recommend the IT Disaster Recovery Plan be developed and implemented by the Shire of Northam. Once the plan has been completed, we recommend it is endorsed and communicated to all staff, implemented and monitored on a regular basis including testing the plan to ensure that in the event of a disaster, appropriate actions can be taken.	Staff are currently looking to develop an IT disaster recovery plan.	Exec Manager Corporate Services	Processes have been put in place they are, onsite and offsite backups, active monitoring for potential cyber attacks etc, new ups for protection against power surges. Documentation of the steps is still pending, expected to be carried out 2 nd or 3 rd Qtr 2019. Updated 28/02/2019
2	We noted there is a Contractor Induction process in place. However, testing identified no evidence that the contractor had attended/completed the Contractor Induction process.	Medium	Risk of non-compliance with stated policies, procedures including relevant health and safety requirements.	We recommend contractors be required to complete some level of induction (the level of induction completed should be determined based on the risks associated with the service or product provided) and the induction process be formally documented as evidence of attendance.	A current register exists even though it is not as extensive as that suggested, the risk register will be updated in the future as recommended.	CEO HR Coordinator	Induction process, documentation and checklist in Promapp for the attention and action of all departments.

Audit Committee Meeting Minutes
9 October 2019



No.	Finding	Finding Rating	Implication	Recommendation	Management Comment	Responsible Officer	Progress to Date
3	Our inquiries of the Executive Manager, Corporate Services indicated that the Shire of Northam does not currently have an ICT Framework in place.	Medium	Risk that existing procedures and practices in respect to information and communication technology are not formally documented.	<p>We recommend the ICT Framework be developed to ensure procedures and practices in respect to information and communication technology is documented and presented to Council for review and adoption. The framework should be monitored on a pre-determined basis to ensure compliance with stated policies and procedures. As part of the development of the ICT framework, we suggest consideration be given to:</p> <ul style="list-style-type: none"> •A formal cost v benefit analysis or feasibility study be completed prior to major ITC projects, including post implementation reviews; •KPI's are set for the IT process and regular monitoring against KPI be performed, including user satisfaction reviews; •Confidentiality clause be included in key service level agreements with external supplies; and •Review of external service level agreements be completed against targets included within those agreements. 	Currently investigating available options.	Exec Manager Corporate Services	An internal audit has been carried out, framework is now being developed, progress to date, IT provider changed, service levels put in place, new service agreement in place, updated 28/02/2019

Audit Committee Meeting Minutes
9 October 2019



No.	Finding	Finding Rating	Implication	Recommendation	Management Comment	Responsible Officer	Progress to Date
4	Our inquiries of Council's Building Supervisor indicated the Shire of Northam does not currently have a signed contract in place with the external security companies used for monitoring and call-outs.	Medium	Risk of the Shire of Northam locations not being protected from break-ins, vandalism etc.	We recommend that contracts are in place with all third parties engaged to provide said security services.	Staff will develop an agreement.	Exec Manager Engineering Services	Contract expired on 30 June 2017. Extension granted until RFQ has been prepared and advertised. For the monitoring and servicing we have some monitoring agreements for individual buildings as they were upgraded to 4g monitoring however we don't have an overall contract for monitoring and servicing. Staff are further investigating.
5	Our inquiries of the Executive Manager, Corporate Services indicated there is no ongoing security awareness program in respect to IT.	Low	Risk of security breaches due to changing security environment.	We recommend an ongoing security awareness program be developed to ensure security needs of the Shire is updated as required (for example due to IT infrastructure or application changes) and to prevent any security breaches from occurring. This could be incorporated as part of Shire of Northam's overall Risk Management Framework.	Staff to investigate. While there is no formal program the Council IT Officer regularly sends notifications in regards to 'cyber alerts' and other potential IT related issues.	Exec Manager Corporate Services	Alerts being sent as they come to light
6	Our inquiries of the Executive Manager, Corporate Services identified that the Shire of Northam computers do not	Low	Risk of someone else using the computer to access information that	We recommend that the Shire of Northam implements a policy where all Shire owned computers are automatically	Staff to investigate and implement.	Exec Manager Corporate Services	Completed June 2017

Audit Committee Meeting Minutes
9 October 2019



No.	Finding	Finding Rating	Implication	Recommendation	Management Comment	Responsible Officer	Progress to Date
	currently automatically log out when left dormant for a period of time. <i>We acknowledge that the licensing computers at the front counter does automatically log out when left dormant.</i>		they do not currently have authority to view and/or amend details in order to receive some benefit etc.	logged out after five minutes of being dormant (or as considered appropriate time limit).			
7	Our inquiries of the Governance Officer identified that there is currently no cash handling policies and procedures in place.	Low	Risk that cash is not being handled appropriately by staff.	We recommend that cash handling policies and procedures are developed and implemented. Once developed, these policies and procedures should be reviewed and approved by Council and then communicated to all staff that handles the Shire's cash.	Staff are verbally informed of the procedures, these however are not written, and staff will look at developing a written procedure.	Exec Manager Corporate Services	Complete - There is a 'Guide to Reception Duties' document at Reception which is maintained and used for training.
8	We note that there is currently no independent review of the general journal adjustments posted to Synergy Soft.	Low	Risk that errors will not be identified in a timely manner.	We recommend that all general journal adjustment journals are independently reviewed and physically signed off by the reviewed as evidence of this review.	The measure will be implemented.	Exec Manager Corporate Services	Implemented.
9	We note that that credit card statements were not signed off to evidence review as required by policy HR 2.7 Credit Card Use.	Low	Risk that fraud or errors will not be identified in a timely manner.	We recommend that all credit card statements are signed off by the reviewer as evidence of this review, as per stated policy.	Credit Cards are independently reviewed by Finance Officer, Accountant, Exec Manager of Corporate Services and finally the Credit Card Holder. It is noted however that the reviewing persons do not sign	Exec Manager Corporate Services	Completed

Audit Committee Meeting Minutes
9 October 2019



No.	Finding	Finding Rating	Implication	Recommendation	Management Comment	Responsible Officer	Progress to Date
					to indicate the review has been completed. This has been corrected. It is also noted that all credit card payments are itemised and presented to Council monthly for review.		
10	We note that the Vehicle Management Policy was currently under review at the time of our on-site visit.	Low	Risk of inappropriate usage of the Shire's fuel cards.	We recommend that the Vehicle Management Policy is finalised and approved by Council. This policy should detail limits and permissible usage. Once endorsed, the policy should be communicated to all staff, implemented and monitored on a regular basis including testing fuel card usage is in accordance with the policy.	Policy expected to be adopted early 2019 following the completion of an independent Fleet Management Practice Review	Exec Manager Engineering Services	The Policy will be presented to Council October 2019
11	Our testing identified instances where the purchase order was raised post receiving the invoice. This finding was raised previously when the Financial Management System Review was performed (report issued in June 2016) and we acknowledge that there have been no unexplainable instances of this occurring	Low	Risk of non-compliance with policies and procedures. Risk of fraud or error not being identified in a timely manner.	We recommend purchase orders are raised and approved prior to the goods/services being incurred by the Shire.	Noted.	Various	Process in place and random audits undertaken by purchasing staff

Audit Committee Meeting Minutes
9 October 2019



No.	Finding	Finding Rating	Implication	Recommendation	Management Comment	Responsible Officer	Progress to Date
	post the issuance of the report.						
12	While best practice methods are used in respect to procurement practices, our testing identified one instance where a Purchasing Procedures Checklist was not attached to the payment documentation for All-ways Foods (invoice number 20368).	Low	Risk of non-compliance with and procedures.	We recommend that the Purchasing Procedures Checklist is completed, signed off and attached to all payment documentation in accordance with stated policy.	Noted.	Various	Implemented and audited by purchasing staff
13	While best practice methods are used in respect to tendering processes, our testing identified that Tender Checklist form was not signed off by the senior checking officer for tender 1 of 2016.	Low	Risk of non-compliance with and procedures.	We recommend that the Tender Checklist is reviewed and signed off by the senior checking officer once the tender process has been completed in accordance with stated policy.	All staff involved have been reminded of the importance of following procedures.	Exec Managers	Completed. A process is currently being developed for 'Managing Tenders'. This will include tasks outlining the requirements for updating and signing off tenders.

**APPENDIX C
SHIRE OF NORTHAM
LEGISLATIVE COMPLIANCE**

No.	Finding	Finding Rating	Implication	Recommendation	Management Comment	Responsible Officer	Progress to Date
1	<p>Our inquiries indicated Shire of Northam does not have a documented legislative compliance manual which is linked to each business unit risk management assessment.</p> <p>While we understand the Chief Executive Officer and Executive Managers Annual Delivery Plan sets out key compliance milestones, however there does not appear to be an overall compliance manual which identifies the legislation (as the first step) and follows the process from this initial point, to risk management.</p>	Medium	Risk of non-compliance with all legislative requirements.	<p>We recommend a compliance manual linked to each business unit risk management assessment be completed and implemented.</p> <p>We would expect the manual to be divided into each business unit section (as identified within the organisation structure) and to:</p> <ul style="list-style-type: none"> Identify relevant legislation to that business unit (for example the Health Act 1911 or the Planning and Development Act 2005 or the Dog Act 1976); Identify key relevant sections within each legislation and note within the compliance manual; Who is responsible for ensuring controls in place to ensure compliance with each identified legislation section; The mechanism in place to ensure compliance, for example a policy or procedure (this component 	Noted.	CEO	Compliance calendar/checklist has been developed.

Audit Committee Meeting Minutes
9 October 2019



No.	Finding	Finding Rating	Implication	Recommendation	Management Comment	Responsible Officer	Progress to Date
				<p>of the compliance manual would link each relevant section of legislation to a policy, procedure, person or other control).</p> <ul style="list-style-type: none"> Regular testing of compliance, for example if the mechanism for compliance is a policy, regular review and spot checking (internal audit) of that policy; any Key milestone / reporting dates applicable to that legislative section and how compliance is met. <p>Once the compliance manual is implemented, we recommend a standing agenda item be added to the Audit Committee meeting agenda to assess the effectiveness of compliance through the review and assessment of the compliance manual.</p>			
2	We noted two Audit and Risk Management Committee meetings were held during the year.	Medium	Risk of governance and oversight responsibilities not being met.	Local Government Operational Guideline Number 09 – Audit in Local Government outlines it is best practice for the Audit Committee to meet on at least a quarterly basis.	Noted and agreed that the committee should be meeting on more regular basis.	CEO	Completed
3	Our inquiries of the Chief Executive Officer identified	Medium	Risk that internal controls are not being adhered to.	We recommend that Council consider conducting relevant internal audits in the years	Currently developing a framework for internal audits.	CEO	Completed July 2018

Audit Committee Meeting Minutes
9 October 2019



No.	Finding	Finding Rating	Implication	Recommendation	Management Comment	Responsible Officer	Progress to Date
	the current Internal Audit Framework incorporates the: (a) Financial Management System Review (conducted every four years, last conducted for the period 1 July 2015 to 30 April 2016); (b) Regulation 17 Review (conducted every two years, the current review for the period 1 July 2015 to 30 October 2016); and (c) DLGC Better Practice Review (conducted every four years, last conducted the end of 2015).			between Financial Management System reviews and Regulation 17 reviews.			
4	We note that the Audit Committee meeting minutes have not been signed by the Presiding Officer for the meeting held on 19 November 2014, 16 March 2015, 25 November 2015 and 8 March 2016.	Medium	Risk of non-compliance with clause 5.22(3) of the Local Government Act 1995.	We recommend that the Presiding Officer signs off the Audit Committee meeting minutes certifying confirmation.	Will ensure this is adhered to in the future.	CEO	Completed

Audit Committee Meeting Minutes
9 October 2019



5.6 IT AUDIT SERVICE REPORT

Address:	N/A
Owner:	Shire of Northam
Applicant:	N/A
File Reference:	1.6.1.6
Reporting Officer:	Colin Young, Executive Manager Corporate Services
Responsible Officer:	Colin Young, Executive Manager Corporate Services
Officer Declaration of Interest:	Nil
Voting Requirement:	Simple Majority
Press release to be issued:	No

BRIEF

This report is to update Council on the progress of the IT Audit Service Report provided by Focus Networks in September 2018.

ATTACHMENTS

Attachment 1: IT Audit Review

A. BACKGROUND / DETAILS

In June 2018 via the audit committee, Council adopted that an internal audit was to be carried out on the resourcing requirements of Council's Information Technology Resourcing. Focus Networks was contracted to carry out a review of Council's IT Infrastructure. There were four objectives noted as requiring attention;

1. Review the Current IT Environment
 - a. Physically inspect certain core IT areas
 - b. Electronically inspect certain core IT areas
 - c. Document current configurations
2. Compare to Industry Best Standards
 - a. Generate a Technology Scorecard
 - b. Generate a priority Timeframes
 - c. Highlight the differences
3. Make Recommendations for the Future
 - a. Rate core IT areas based on risk
 - b. Document areas of concern

c. Suggest the implications

4. Suggest Budget Estimates
 - a. Propose alternative solutions
 - b. High and medium IT areas
 - c. Include hardware/software/labour

The core areas audited and documented where:

1. Plans Procedures & Designs
2. Environment & Communications
3. Computers & Network Hardware

Furthermore, Council's network was hit by a crypto virus on 18 August 2018, this attack highlighted the need for an urgent review of Council's network.

B. CONSIDERATIONS

B.1 Strategic Community / Corporate Business Plan

Theme Area 6: Governance & Leadership

Outcome 6.3: The Shire of Northam council is a sustainable, responsive, innovative and transparent organisation.

Objective: Provide outstanding customer service.
Maintain a high standard of corporate governance.

B.2 Financial / Resource Implications

N/A

B.3 Legislative Compliance

There is no legislative requirement to hold an IT Service Review, however it is best practice.

B.4 Policy Implications

Nil.

B.5 Stakeholder Engagement / Consultation

Nil.

B.6 Risk Implications

Risk Category	Description	Rating (consequence x likelihood)	Mitigation Action
Financial	The cost of cyber-attacks can be extremely high	Minor (2)	Put processes in place to mitigate attack

Audit Committee Meeting Minutes
9 October 2019



Health & Safety	N/A	N/A	N/A
Reputation	Any disruption to Councils IT infrastructure impacts members of the community and may give them a poor reflection of dealing with Council.	Minor (2)	Put processes in place to mitigate attack
Service Interruption	Disruption to the service provided by Council	Medium (3)	Put processes in place to mitigate attack
Compliance	N/A	N/A	N/A
Property	N/A	N/A	N/A
Environment	N/A	N/A	N/A

C. OFFICER'S COMMENT

Since the last Cyber-attack in 2018, an agreement has been signed between the Shire and JH Computer Services to provide two levels of support.

Level 1 Monitoring and Maintenance

Examples include but are not limited to:

- Monitoring Server Uptime;
- Being made aware if Server goes offline;
- Monitoring and maintain Backups;
- Monitoring and managing Hard Disk Utilisation;
- Monitoring, notifying and instigating repair of Hardware faults; and
- Checking Windows updates that are required.

Level 2 Support Packs

Such as auditing and review services which include:

- Backup and Disaster Recovery Assessment;
- Network Performance Assessments;
- Virus and Security Assessments;
- Network Hardware Review; and
- Communications Review (ie. ADSL connections)

In the attached table it describes the actions taken by the Shire to address the IT issues raised by Focus Networks.

Key to table

Audit Committee Meeting Minutes
9 October 2019



Completed

No Action

Underway

Officers are working towards addressing the areas for further development whilst continuing the improvements already underway in order to achieve good practice, governance and legislative compliance into the future. The action plan for the review has been provided in Attachment 1 with an update of the progress made towards the recommendations.

RECOMMENDATION / COMMITTEE DECISION

Minute No: AU.128

Moved: Cr Antonio

Seconded: Cr Mencshelyi

That Council receive the update as provided in Attachment 1 in relation to the progress made towards the IT Audit Review.

CARRIED 2/0

The Executive Manager Corporate Services advised that everything high risk has been dealt with and many of the outstanding items have measures in place however these are not documented. Officers are confident that these are under control and the risk is managed.

Clarification was sought in relation to whether there is off site backups? The Executive Manager Corporate Services confirmed that this is occurring in addition to on site backups. There are procedures in place for IT recovery. It was noted that Council has changed IT providers which are providing a better service than the previous providers.

Attachment 1

No.	Priority Areas	Finding Rating	Current	Recommendation	Responsible Officer	Progress to Date
1	Backups	HIGH Score 1.5	<p>Two backup technologies are used</p> <p>The backup runs daily Monday to Friday and are stored on a share on the NSC-HYPERV physical server. A retention period for NSC-DATABASE could not be documented.</p> <p>A backup exists on the NSC-FILE virtual server and NSC-TS physical server. This backup runs daily Monday to Sunday at 9PM. A retention period of 7 days exists for NSC-TS and 28 days for NSC-DATABASE. These are stored onsite in a fire proof safe right next to the server room. Once a week the hard drives are taken offsite by staff. Notifications are emailed to the ICT shared mailbox.</p> <p>Focus Networks could not confirm failures for the past month.</p>	<p>An onsite and offsite backup and recovery solution should be kept as simple as possible and include the following.</p> <ul style="list-style-type: none"> Onsite and offsite retention of backups Minimum hourly snapshots Hourly dailey, weekly, monthly and annual retention periods Regular recovery testing Daly backup notifications <p>It is important to do regular scheduled Disaster recovery testing to ensure all is working as intended.</p>	Executive Manager Corporate Services	Now utilising Acronis, taking multiple daily snapshots as well as offsite backups.
2	Internet Gateway	HIGH Score 1.5	<p>Current firewall offers protection for less than 1% of these vulnerabilities.</p> <p>A Juniper device managed by Telstra is a basic router that offers no security services for Website Content Filtering, Gateway Anti-Virus or Gateway Anti-Spyware (also referred to as Deep Packet Inspection). These security services are supposed to be the first line of defence for incoming Internet traffic.</p>	<p>It is imperative that a deep packet scanning corporate firewall be utilised at all sites for both unencrypted and encrypted traffic providing protection from Internet attacks and misbehaving users. As of today, known virus, intrusion and spyware vulnerabilities are numbered at over 31,000.</p>	Executive Manager Corporate Services	Hardware based deep packet scanning corporate firewall has been implemented via a Fortigate router. This has also allowed us to better manage and monitor our network and circumvent the complications and delays brought about by

Audit Committee Meeting Minutes
9 October 2019



No.	Priority Areas	Finding Rating	Current	Recommendation	Responsible Officer	Progress to Date
3	Anti-Virus	HIGH Score 1	The cloud based solution is used this makes remote agent monitoring and management a little easier. It is confirmed there is a license count of 80 with 75 in use. 17 agents were outdated and ransomware protection was disabled. No scheduled scans have been created for the servers or desktops and no scheduled reporting was enabled. Notifications were set to email ithelp@northam.wa.gov.au	Corporate grade anti-virus and anti-spam protection is a priority and proactive monitoring is required. Weekly scanning and reporting is imperative. A centrally located management console must be used to push out and update all machines at all sites	Executive Manager Corporate Services	the Telstra MPLS side of things. Have upgraded to the latest Trend, WFBS is implemented on servers, all workstations are also using Trend as an anti-spam solution for emails.
4	IT Support	HIGH Score 1	IT support is delivered using a mix of internal resources and an external contractor being PCS. Neither have full visibility of all components and no sharing mechanisms. This can lead to confusion and inevitably a finger pointing exercise. The Telstra MPLS network is fully managed generally locking out the client to making network/security modifications unless a ticket is generated. The response times from Telstra on these tickets can take days/weeks. The Library was following a different strategy and appeared to run under an independent IT model.	A proactive support mechanism implemented with a helpdesk solution should aim at keeping all parties up to date at all times. Helpdesk calls should be updated when a system change is required or when a request is completed. Regular helpdesk reporting can help identify underlying issues and a searching ability should allow engineers to track and troubleshoot problems. Documentation and communication build a strong relationship.	Executive Manager Corporate Services	We now have a ticketing system using Fresh desk as our online ticketing system. Goes to all on the IT team including our external support. The system gives IT staff the ability to monitor and review work history for trends. We also have a support agreement in place with JHCS, whom monitor Councils servers, backups etc remotely.

Audit Committee Meeting Minutes
9 October 2019



No.	Priority Areas	Finding Rating	Current	Recommendation	Responsible Officer	Progress to Date
			<p>Calls for help are not documented in a helpdesk ticketing system. No utilisation statistics can be documented.</p> <p>PCS provide Level 2 and Level 3 remote IT support on an adhoc basis which can total up to 3 hours per week.</p> <p>No remote monitoring or infrastructure maintenance is delivered but after hours support is offered via mobile phone. There are no Service Level Agreements (SLA's) or minimum response times provided and no management reports.</p>			
5	ISP Links	<u>MEDIUM</u> Score 1.5	<p>The Telstra MPLS NBN link uses FTN. This services uploads and downloads speeds are different. The Telstra MPLS NBN link was running at a speed of 43Mbps down and 2Mbps up.</p> <p>The secondary link is a Telstra ADSL link that uses copper. This service is an asynchronous service which means the upload and download speeds are different.</p> <p>The Head office lacks a fast redundant ISP link but this would be due to the design of the MPLS network as the hop off point for the Internet would be in the Telstra MPLS cloud. The NBN FTN disconnection for copper services would affect ADSL services.</p>	<p>Business grade Internet services will offer better contention ratios. Redundant links using different Internet technologies on a corporate firewall can increase uptime and will improve Internet browsing, site to site connectivity or cloud connections.</p>	Executive Manager Corporate Services	<p>MPLS given 30 days notice. We are going with TPG to give us a link to the building. They will replace what Telstra couldn't deliver.</p> <p>We are also in process of linking remote offices with Administration building via own airfibre / wireless links which replace our dependence on NBN and ADSL services.</p>

Audit Committee Meeting Minutes
9 October 2019



No.	Priority Areas	Finding Rating	Current	Recommendation	Responsible Officer	Progress to Date
6	IT DR Plan	<u>MEDIUM</u> Score 0	<p>There is no current IT DR plan. A very basic document called "Information & Communication Technology Strategy 2018-2022" did contain one page on disaster recovery but the content was extremely poor. It was also noted that a document from LGIS called "Crisis Management & Business Continuity response Plan" did exist and referenced the IT DR Plan on page 25 but no current IT DR plan exists.</p> <p>As no plan exists, the organisation is relying on the current backup regime to restore data in the event of a disaster. Unfortunately as recent events have shown, the backup regime was proved to be inefficient.</p>	<p>An IT Disaster Recovery Plan is a key element of business continuity management. It should be clear and concise, focus on the key activities required to recover the critical IT services, be tested reviewed and updated on a regular basis, have an owner and enable the recovery objectives to be met. As part of this exercise a Critical Systems Analysis document is to be completed to document business functions which are delivered using internal and external technologies.</p>	Executive Manager Corporate Services	<p>Our IT DR plan is still more adhoc than formalised but has been formally identified for actioning at a recent IT forward planning meeting with JHCS, our main ICT support vendor. A form of DR testing has been carried out by way of migration of servers / data to new servers. We are also in the process of repurposing our old servers and NAS devices for DR / service continuity.</p>
7	Strategic IT Plan	<u>MEDIUM</u> Score 0	<p>There is no current Strategic IT Plan. The "Information & Communication Technology Strategy 2018-2022" did contain four pages on strategy but the content was extremely poor.</p> <p>No standard purchasing policy is defined for replacing computers based on time, age or life cycle. No other structured plans are set for larger IT related projects as no particular direction for strategy is defined. Very little detailed technical documentation exists.</p>	<p>There needs to be an overall approach for the selection, use and support of technology that aligns with the client's resources, business needs and processes. A Strategic IT Plan provides direction for addressing both short-term needs and long-term requirements for cost-effective, practical technological solutions.</p>	Executive Manager Corporate Services	<p>The "strategic IT plan" for the last year has been more about recovery and rebuilding the essentials while retaining service delivery but we are now finally in a far better position to develop a broader IT strategy. Identification of priorities has been determined and JHCS, our main ICT support</p>

Audit Committee Meeting Minutes
9 October 2019



No.	Priority Areas	Finding Rating	Current	Recommendation	Responsible Officer	Progress to Date
						vendor, engaged to assist in what needs to be achieved.
8	Windows Updates	<u>MEDIUM</u> Score 1	The two physical servers were last updated on the 19 th of August. As this is a Sunday we assume IT completed the updates. The single virtual server NSC-FILE was last updated on the 21 st of August which places the network at significant risk. All desktops are configured to receive updates through group policy, forcing all machines to update from Microsoft servers. No central WSUS server is present, which places more load on the internet links, and prevents reporting on the current state of patching. All desktops audited had less than 10 important updates pending. No test groups or pilot groups for desktops were evident for updates. This means that all updates are simply	Microsoft Windows Server Update Services (WSUS) or alternative 3 rd party management tools, enable administrators to deploy the latest Microsoft product updates to computers running the Windows operating system. By using WSUS or these tools, administrators can fully manage the distribution of updates that are released through Microsoft Update to computers in their network.	Executive Manager Corporate Services	Equipment has been identified and reserved for the creation of a suitable test environment that will occur once higher priority issues are resolved. Better control of windows desktop updates is planned and updates of windows servers are monitored.

Audit Committee Meeting Minutes
9 October 2019



No.	Priority Areas	Finding Rating	Current	Recommendation	Responsible Officer	Progress to Date
			installed without testing, which is not recommended.			
9	Printing	<u>MEDIUM</u> Score 1	<p>Centralised printing is via at least ten printers setup as direct IP printing on Server 2008 R2. The IP addresses used for the network were not all in sequential order.</p> <p>Canon, HP and Brother printers were confirmed onsite no standard purchasing policy exists.</p> <p>No secure print functionality was witnessed on the larger multi function printers.</p>	<p>Centralised printing should be implemented to reduce ongoing consumable costs. Highly sensitive printing for the payroll or HR department should be implemented with a private/local printer. Network sharing should always be chosen over direct printing and the secure or distributed option of printing should be investigated.</p> <p>Locations of printers from an OHS point of view should be addressed for ventilation and noise requirements.</p>	Executive Manager Corporate Services	We are currently investigating options.

Audit Committee Meeting Minutes
9 October 2019



No.	Priority Areas	Finding Rating	Current	Recommendation	Responsible Officer	Progress to Date
10	Servers	LOW Score 0.5	Three white box physical servers reside in the server cabinet. They are all configured with redundant power supplies running from a single Eaton UPS. The second Eaton UPS in the rack is faulty and not in use. There is no remote management port options available on these servers. The white box physical servers are not covered under a warranty. Connectivity to the network is 1Gb via a single CAT5 Ethernet cable. Redundant network interfaces are not utilised on all servers	A tier 1 server platform utilising the N+1 architecture delivers an increased uptime by offering redundant power supplies, redundant network connections, onboard remote management and extended warranties.	Executive Manager Corporate Services	Servers have been upgraded and storage increased and connectivity to the network is via managed switches configured to deliver 4Gb (bonded 4 x 1Gb) links. Servers are remotely monitored by JHCS our main ICT support vendor.
11	Local Area Network	LOW Score 1	Three switches are rack mounted in the comms cupboard. Unfortunately all devices are powered by mains power only. A Netgear FS524 24 port 10/100 switch has no ports free. A Netgear Prosafe GS748T 48 port gigabit switch has approximately 8 ports free. A HP J3188A 16 port 10Base-T hub has approximately 10 ports free. One switch is rack mounted in the server rack in the printing room. A Netgear Prosafe JGS524 24 port gigabit switch has 18 ports free.	Managed switches should be backed by a lifetime product warranty. Power over Ethernet (PoE) functionality should be investigated if a VOIP phone system is utilised. Management capabilities (HTTP and SNMP) will also aid in network fault finding and usage reporting. Non managed switches can decrease intelligence and performance. Wi-Fi access points can be configured on different frequency ranges. Each range is divided into channels. Fine tuning can increase performance gains. Wireless network access can also be configured using SSIDs and VLANs for internal use and/or public use.	Executive Manager Corporate Services	Most gear mentioned in this section of the audit has since been replaced and all of it is now on a UPS. We are now running smart / managed PoE switches and a Fortigate router configured to handle multiple sources of network connectivity, deep packet scanning, VPNs, VLANs, and Wifi hotspots, etc.

Audit Committee Meeting Minutes
9 October 2019



No.	Priority Areas	Finding Rating	Current	Recommendation	Responsible Officer	Progress to Date
			There is no evidence of separated networks (referred to as VLANs).			
12	Uninterrupted Power Supply (UPS)	<u>LOW</u> Score 1	<p>Two Eaton UPS reside in the server rack in the printing room. We are confident that the Eaton 9125 RM UPS is end of life and faulty.</p> <p>No SNMP card or EMP probe for monitoring were witnessed therefore no Eaton shutdown software was loaded to gracefully restart the powered servers in the event of a temperature or humidity rise.</p>	<p>A UPS filters supplied power Load segments can be defined to shutdown non-critical equipment first. The SNMP protocol is used to record and monitor incoming and outgoing voltages. Most importantly, UPS shutdown software should be installed and configured to shut down the servers gracefully during an extended power outage and power them back on after clean power has been restored.</p>	Executive Manager Corporate Services	The main server and NAS storage and switch is on a managed UPS configured to shutdown the server in the event of an extended outage and its effectiveness was tested (including power down / back on) during a power outage earlier this year. One of the two older Eaton UPS devices has been repurposed to provide protected power to the managed switches and other gear in a separate comms cabinet. The audit assessment of the Eaton 9125 UPS was correct and

Audit Committee Meeting Minutes
9 October 2019



No.	Priority Areas	Finding Rating	Current	Recommendation	Responsible Officer	Progress to Date
						it has since been decommissioned.

UNCONFIRMED

Audit Committee Meeting Minutes
9 October 2019



5.7 RISK REGISTER

Address:	N/A
Owner:	Shire of Northam
Applicant:	
File Reference:	8.2.7.1
Reporting Officer:	Jason Whiteaker Chief Executive Officer
Responsible Officer:	Jason Whiteaker Chief Executive Officer
Officer Declaration of Interest:	NIL
Voting Requirement:	Simple majority
Press release to be issued:	No

BRIEF

To provide Council with information pertaining to the organisational risk register

ATTACHMENTS

- Attachment 1: Overdue Non-compliant Risks.
Attachment 2: Risk Register.

A. BACKGROUND / DETAILS

The Shire of Northam have an organisational wide risk register which has been developed over a period of time. Council has been advised previously that the management of risk is an area which has been under developed within the Shire of Northam and an area which was receiving a focus to ensure the Elected Council was aware of the identified risks and treatments strategies in place.

To assist in the effective management of risk the Shire of Northam are using the Promapp system, which allows for recording of organisational risks and the tracking of the associated treatment actions.

B. CONSIDERATIONS

B.1 Strategic Community / Corporate Business Plan

Theme Area6: Governance & Leadership.

Outcome 6.4: The Elected Members of the Shire of Northam provide accountable, strong and effective community leadership.

Audit Committee Meeting Minutes
9 October 2019

Objective: Develop clear policy settings to guide our organisation and community.

B.2 Financial / Resource Implications

Council allocates \$27,000 per annum for the Promapp system. Promapp is used for process mapping, risk management and OHS management.

B.3 Legislative Compliance

AS/NZS ISO 31000:2009

B.4 Policy Implications

Council has recently endorsed policy G1.11 – Risk Management

B.5 Stakeholder Engagement / Consultation

Council was involved in the development of the risk management policy and the past endorsement of the risk management plan

B.6 Risk Implications

Risk Category	Description	Rating (consequence x likelihood)	Mitigation Action
Financial	Nil.	N/A	N/A
Health & Safety	Nil.	N/A	N/A
Reputation	Negative community perception due to lack of adequate risk management practices within the Shire of Northam	Moderate Minor/Possible 6	Per recommendation within this report
Service Interruption	Nil.	N/A	N/A
Compliance	Non-compliance of Australian Standards and legislation due to lack of risk management practices.	Moderate Minor/Possible 6	Per recommendation within this report
Property	Nil.	N/A	N/A
Environment	Nil.	N/A	N/A

C. OFFICER'S COMMENT

As part of the risk management policy Council has established two main performance indicators being;

Audit Committee Meeting Minutes
9 October 2019



1. % of high or extreme risks without mitigation / treatment strategies in place;
Currently all high or extreme risks have mitigation/treatment strategies
2. % of risk mitigation / treatment strategies over due
Currently have 82 risk mitigation/treatment strategies, of which 4 are overdue (which equates to 4.8%)

2.1 TREATMENT MC00042

Implement recommendations from OHS Audit & Report to Audit & Risk Committee

Progress

Audit has been completed, waiting for final report and recommended actions.

2.2 TREATMENT MC00046

OHS Policy Framework in place and reviewed

Progress

Currently finalising formal framework

2.3 TREATMENT MC00068

Aquatic facility Project Superintendent (Donovan Payne) reports to be provided monthly

Progress

Project report not provided at time of writing report. Will be received in coming weeks.

2.4 TREATMENT MC00005

Review Human Resource Plan to ensure it is reflective of strategic community plan

Progress

Review completed, waiting to present plan to new Council

As this represents the first meeting where the risk register has been discussed by the Committee, a list of the risk register (identifying the top ten risk areas (based on scores)) including the mitigation/treatment strategies has been appended for the information and discussion of the Committee.

Audit Committee Meeting Minutes
9 October 2019

RECOMMENDATION / COMMITTEE DECISION

Minute No: AU.129

Moved: Cr Antonio
Seconded: Cr Mencshelyi

That Council receive September 2019 Shire of Northam Risk Register update.

CARRIED 2/0

An overview was provided of the Promapp software / the Council's risk register.

Clarification was sought in relation to how additional risks are added. Officers advised that the recently adopted Risk Policy provides guidance in relation to this.

Audit Committee Meeting Minutes
9 October 2019



Overdue / Non-Compliant Risks

Attachment 1



Filter: Overdue / Non-compliant

<p>RESIDUAL 4.8 MODERATE</p> <p>INHERENT 16.0</p> <p>R00022</p>	<p>CHIEF EXECUTIVES OFFICE, HEALTH & SAFETY - OCCUPATIONAL</p> <p>Inadequate safety and security practices Non-compliance with the Occupation Safety & Health Act, associated regulations and standards. It is also the inability to ensure the physical security requirements of staff, contractors and visitors. Other considerations are:</p> <ul style="list-style-type: none"> Inadequate Policy, Frameworks, Systems and Structure to prevent the injury of visitors, staff, contractors and/or tenants. Inadequate Organisational Emergency Management requirements (evacuation diagrams, drills, wardens etc). Inadequate security protection measures in place for buildings, depots and other places of work (vehicle, community etc). Public Liability Claims, due to negligence or personal injury. Employee Liability Claims due to negligence or personal injury. Inadequate or unsafe modifications to plant & equipment <p>OWNER Jason Whiteaker CREATED 01/07/2019 06:46:30 LIKELIHOOD Likely SEVERITY Major CONTROL EFFECTIVENESS Strong</p>	<p>TREATMENT MC00041 Undertake OHS Audit</p> <p>SIGNOFF(S): Bev Jones DUE DATE: 01 Sep 2021 FREQUENCY: The first Day of every 24 months</p>
	<p>TREATMENT MC00042 Implement recommendations from OHS Audit & Report to Audit & Risk Committee</p> <p>NON-COMPLIANT SIGNOFF(S): Bev Jones DUE DATE: 30 Sep 2019 FREQUENCY: The last Day of every 4 months</p>	
	<p>TREATMENT MC00043 OHS Committee Meeting Regularly</p> <p>SIGNOFF(S): Bev Jones DUE DATE: 31 Dec 2019 FREQUENCY: The last Day of every 3 months</p>	
	<p>TREATMENT MC00044 Toolbox meetings occurring and discussing safety (attach minutes/notes to sign off)</p> <p>SIGNOFF(S): Clinton Kleynhans DUE DATE: 31 Oct 2019 FREQUENCY: The last Day of every month</p>	
	<p>TREATMENT MC00045 Senior Management Meeting (where the OSH system is reviewed and KPI's are measured as an agenda item)</p> <p>SIGNOFF(S): Jason Whiteaker DUE DATE: 30 Sep 2019 FREQUENCY: The last Day of every 6 months</p>	
	<p>TREATMENT MC00046 OHS Policy Framework in place and reviewed</p> <p>NON-COMPLIANT SIGNOFF(S): Bev Jones DUE DATE: 30 Aug 2019 FREQUENCY: The last Day of every 12 months</p>	
	<p>TREATMENT MC00053 Project management framework in place, providing parameters for staff to operate within</p> <p>SIGNOFF(S): Jason Whiteaker DUE DATE: 31 Jul 2020 FREQUENCY: The last Day of every 12 months</p>	

Audit Committee Meeting Minutes
9 October 2019



RESIDUAL
3.6
LOW

INHERENT
12.0

R00027

MAJOR PROJECT - AQUATIC FACILITY, FINANCIAL - OPERATIONAL, HEALTH & SAFETY, PROPERTY - LIABILITY, REPUTATION - COMMUNITY, STRATEGIC - COMMUNITY

Ineffective Project Management
Project not managed effectively

OWNER Jason Whiteaker
CREATED 01/07/2019 08:29:57
LIKELIHOOD Possible
SEVERITY Major
CONTROL EFFECTIVENESS Strong

TREATMENT MC00054
Major Project status reporting to Council (through monthly elected member report)

SIGNOFF(S): Alysha McCall
DUE DATE: 07 Oct 2019
FREQUENCY: 7th day of every month

TREATMENT MC00064
Independent Project Superintendent appointed with requisite skills to acknowledge scale and complexity of this project

SIGNOFF(S): Jason Whiteaker
DUE DATE:
FREQUENCY: Once

TREATMENT MC00067
Construction project progress reports to be provided

SIGNOFF(S): Jason Whiteaker
DUE DATE: 05 Oct 2019
FREQUENCY: 5th day of every month

TREATMENT MC00068
Project Superintendent (Donovan Payne) reports to be provided monthly

OVERDUE
SIGNOFF(S): Jason Whiteaker
DUE DATE: 19 Sep 2019
FREQUENCY: 19th day of every month

TREATMENT MC00069
Financial variations to be signed off by Project Manager

SIGNOFF(S): Jason Whiteaker
DUE DATE: 05 Oct 2019
FREQUENCY: 5th day of every month

TREATMENT MC00070
All request for information and clarification to be signed off / cited by Council Project Manager

SIGNOFF(S): Jason Whiteaker
DUE DATE: 05 Oct 2019
FREQUENCY: 5th day of every month

TREATMENT MC00071
Project assessment / evaluation to be undertaken at completion and reported to audit committee

SIGNOFF(S): Jason Whiteaker
DUE DATE: 16 Feb 2020
FREQUENCY: Once

TREATMENT MC00074
Project time delays to be signed off in accordance with contract

SIGNOFF(S): Jason Whiteaker
DUE DATE: 05 Oct 2019
FREQUENCY: 5th day of every month

Audit Committee Meeting Minutes
9 October 2019



RESIDUAL
3.6
LOW

INHERENT
12.0

R00002

CHIEF EXECUTIVES OFFICE, STRATEGIC - ORGANISATIONAL

Inappropriate Organisational Structure

Unable to achieve organisational objectives as the Organisation is not structured appropriately

OWNER Jason Whiteaker
CREATED 09/04/2019 03:32:51

LIKELIHOOD Likely
SEVERITY Medium
CONTROL EFFECTIVENESS Strong

TREATMENT MC00003

Review Strategic Community Plan every two years (desktop) and four years (major). Reviews to coincide with new Council being elected

SIGNOFF(S): Jason Whiteaker

DUE DATE: 18 Dec 2019

FREQUENCY: The last Day of every 24 months

TREATMENT MC00004

Review Corporate Business Plan annually to ensure reflects strategic community plan

SIGNOFF(S): Jason Whiteaker

DUE DATE: 30 Jun 2020

FREQUENCY: The last Day of every 12 months

TREATMENT MC00005

Review Human Resource Plan to ensure it is reflective of strategic community plan

NON-COMPLIANT

SIGNOFF(S): Bev Jones

DUE DATE: 15 May 2019

FREQUENCY: The last Day of every 12 months

TREATMENT MC00006

Corporate Business Plan clearly articulates how organisational objectives will be achieved

SIGNOFF(S): Jason Whiteaker

DUE DATE: 30 Jun 2020

FREQUENCY: The last Day of every 12 months

UNCONFIRMED

Top 10 Risk Scores

Attachment 2

Filter: Top 10 Risk Scores

RESIDUAL
9.6
HIGH

INHERENT
12.0

R00023

CORPORATE SERVICES, SERVICE INTERRUPTION

Failure of IT &/or Communications Systems and Infrastructure

Instability, degradation of performance, or other failure of IT Systems, Infrastructure, Communication or Utility causing the inability to continue business activities and provide services to the community. This may or may not result in IT Disaster Recovery Plans being invoked. Examples include failures or disruptions caused by:

- Hardware &/or Software
- IT Network
- Failures of IT Vendors

This also includes where poor governance results in the breakdown of IT maintenance such as;

- Configuration management
- Performance Monitoring
- IT Incident, Problem Management & Disaster Recovery Processes

This does not include new system implementations - refer "Inadequate Project / Change Management".

OWNER Colin Young
CREATED 01/07/2019 06:58:09

LIKELIHOOD Possible
SEVERITY Major
CONTROL EFFECTIVENESS Adequate

TREATMENT MC00047	Data Back-up Systems in place and documented	SIGNOFF(S): DUE DATE: FREQUENCY:	Colin Young 30 Sep 2019 The last Day of every 12 months
TREATMENT MC00048	Disaster Recovery Plan in place	SIGNOFF(S): DUE DATE: FREQUENCY:	Colin Young 30 Sep 2019 The first Day of every 12 months

UNCONFIRMED

Audit Committee Meeting Minutes
 9 October 2019



RESIDUAL 9.6 HIGH INHERENT 12.0 R00040	AMP - BUILDINGS, SERVICE INTERRUPTION AM Service Levels not met Asset Management Plan identifies need to establish and monitor a range of service levels to ensure Council and community expectations are met	TREATMENT MC00019 Up to date and accurate building asset management plan in place	SIGNOFF(S): Clinton Kieynhans Colin Young DUE DATE: 01 Jun 2021 FREQUENCY: The first Day of every 24 months
	OWNER Shane Moorhead CREATED 16/07/2019 03:24:02 LIKELIHOOD Likely SEVERITY Medium CONTROL EFFECTIVENESS Adequate		
RESIDUAL 7.5 MODERATE INHERENT 25.0 R00004	CORPORATE SERVICES, STRATEGIC - ORGANISATIONAL Inadequate Insurance Organisation is exposed to financial loss due to failure to renew public indemnity insurance or renew it with adequate cover	TREATMENT MC00001 Insurance coverage reviewed internally prior to presenting to Chief Executive Officer for sign off	SIGNOFF(S): Colin Young DUE DATE: 01 Jul 2020 FREQUENCY: The first Day of every 12 months
	OWNER Colin Young CREATED 06/05/2019 05:42:09 LIKELIHOOD Almost Certain SEVERITY Extreme CONTROL EFFECTIVENESS Strong	TREATMENT MC00062 Insurance coverage assessed independently for adequacy	SIGNOFF(S): Colin Young DUE DATE: 31 May 2020 FREQUENCY: The first Day of every 48 months

UNCONFIRMED

Audit Committee Meeting Minutes
9 October 2019



<p>RESIDUAL 7.5 MODERATE</p> <p>INHERENT 25.0</p> <p>R00011</p>	<p>CORPORATE SERVICES, COMPLIANCE - LEGISLATIVE, FINANCIAL - OPERATIONAL</p> <p>Inadequate procurement / tender process</p> <p>Council fails to meet legislative obligations, Council policy and Council delegations relating to procurement resulting in departmental investigation, potential disciplinary action, poor financial outcomes and reputation damage.</p> <p>OWNER Executive Manager Corporate Services (Portfolio Manager)</p> <p>CREATED 07/05/2019 02:29:20</p> <p>LIKELIHOOD Almost Certain</p> <p>SEVERITY Extreme</p> <p>CONTROL EFFECTIVENESS Strong</p>	<p>TREATMENT MC00008</p> <p>Manage Purchasing - Request approval</p> <p>Establish and comply with a purchasing policy.</p>	<p>SIGNOFF(S): Colin Young Kristy Hopkins</p> <p>DUE DATE: 01 May 2021</p> <p>FREQUENCY: The first Day of every 24 months</p>
	<p>TREATMENT MC00009</p> <p>Monthly random internal audit of five (5) purchases to be performed to ensure compliance with purchasing requirements.</p>	<p>SIGNOFF(S): Cheryl Greenough</p> <p>DUE DATE: 14 Oct 2019</p> <p>FREQUENCY: 14th day of every month</p>	
	<p>TREATMENT MC00010</p> <p>Ensure the delegated authority register is up to date for tenders and purchases through E-Quotes.</p>	<p>SIGNOFF(S): Cheryl Greenough</p> <p>DUE DATE: 14 Oct 2019</p> <p>FREQUENCY: 14th day of every month</p>	
<p>RESIDUAL 7.2 MODERATE</p> <p>INHERENT 9.0</p> <p>R00015</p>	<p>CORPORATE SERVICES, COMPLIANCE - LEGISLATIVE, SERVICE INTERRUPTION</p> <p>Records Management</p> <p>Important information unable to be found and legislative requirements not met as a result of inadequate records management plans and practices</p> <p>OWNER Colin Young</p> <p>CREATED 24/05/2019 06:58:42</p> <p>LIKELIHOOD Possible</p> <p>SEVERITY Medium</p> <p>CONTROL EFFECTIVENESS Adequate</p>	<p>TREATMENT MC00023</p> <p>Manage Records - File record</p> <p>Process which explains how to register all records incoming and outgoing</p>	<p>SIGNOFF(S): Colin Young Kristy Hopkins</p> <p>DUE DATE:</p> <p>FREQUENCY: Once</p>
	<p>TREATMENT MC00024</p> <p>Current Records Management Plan in place</p>	<p>SIGNOFF(S): Marlene Plews Colin Young</p> <p>DUE DATE: 21 May 2020</p> <p>FREQUENCY: The first Day of every 48 months</p>	
	<p>TREATMENT MC00025</p> <p>Manage Document Control - Identify Document Need</p> <p>Have an effective document control system in place</p>	<p>SIGNOFF(S): Colin Young Kristy Hopkins</p> <p>DUE DATE: 29 May 2020</p> <p>FREQUENCY: The first Day of every 12 months</p>	

Audit Committee Meeting Minutes
9 October 2019



RESIDUAL 7.2 MODERATE INHERENT 9.0 R00018	CHIEF EXECUTIVES OFFICE, REPUTATION - COMMUNITY Inadequate engagement with Community / Stakeholders / Elected Members Failure to maintain effective working relationships with the Community (including Local Media), Stakeholders, Key Private Sector Companies, Government Agencies and / or Elected Members. This invariably includes activities where communication, feedback and / or consultation is required and where it is in the best interests to do so.	TREATMENT MC00032 Current Community Engagement Plan in Place	SIGNOFF(S): Jason Whiteaker DUE DATE: 30 Sep 2019 FREQUENCY: The first Day of every 112 months
	OWNER Jason Whiteaker CREATED 19/08/2019 01:07:22 LIKELIHOOD Possible SEVERITY Medium CONTROL EFFECTIVENESS Adequate	TREATMENT MC00033 Biennial Customer Satisfaction & Community Needs Survey	SIGNOFF(S): Jason Whiteaker DUE DATE: 01 Sep 2021 FREQUENCY: The first Day of every 24 months
RESIDUAL 7.2 MODERATE INHERENT 9.0 R00019	DEVELOPMENT SERVICES, ENVIRONMENTAL - NATURAL Inadequate environmental management inadequate prevention, identification, enforcement and management of environmental issues. The scope includes:	TREATMENT MC00061 Up to Date and endorsed Strategic Waste Management Plan	SIGNOFF(S): Carmen Sadleir Chadd Hunt DUE DATE: 31 Aug 2020 FREQUENCY: The last Day of every 12 months
	<ul style="list-style-type: none"> • Contaminated sites. / Coastal issues • Waste facilities (landfill / transfer stations). / Groundwater • Weed control. / Water Quality • Illegal dumping. • Illegal clearing / land use. OWNER Carmen Sadleir CREATED 01/07/2019 06:28:54 LIKELIHOOD Possible SEVERITY Medium CONTROL EFFECTIVENESS Adequate	TREATMENT MC00082 Have climate change policy in place	SIGNOFF(S): Jenny Abbott Chadd Hunt DUE DATE: 31 Mar 2020 FREQUENCY: The first Day of every 24 months

Audit Committee Meeting Minutes
9 October 2019



RESIDUAL
6.0
MODERATE

INHERENT
20.0

R00021

CORPORATE SERVICES, FINANCIAL - OPERATIONAL, FINANCIAL - STRATEGIC

Inadequate Financial, Accounting or Business Acumen

Inadequate identification or quantification of financial exposure or risk associated with decisions to invest in land transactions, financial derivatives or investments or poor long term forecasting / assumptions. Examples include:

- Poor credit management (short or long term borrowing restricting capacity or flexibility).
- Ineffective market analysis (over or under estimating).
- Ineffective Business Planning (poor scope / competition analysis).
- Ineffective financial modelling, forecasting and projection techniques / processes.

OWNER Colin Young
CREATED 01/07/2019 06:34:50

LIKELIHOOD Likely
SEVERITY Extreme
CONTROL EFFECTIVENESS Strong

TREATMENT MC00034 Long Term Financial Plan in Place	SIGNOFF(S): Colin Young DUE DATE: 01 Jul 2020 FREQUENCY: The first Day of every 12 months
TREATMENT MC00035 Annual Budget adopted and aligned with long term financial plan	SIGNOFF(S): Colin Young DUE DATE: 31 Jul 2020 FREQUENCY: The last Day of every 12 months
TREATMENT MC00036 Investment strategy / policy in place	SIGNOFF(S): Colin Young DUE DATE: 01 Jul 2020 FREQUENCY: The first Day of every 12 months
TREATMENT MC00037 Manage Debtors - Identify Debtor Process to manage general debtors	SIGNOFF(S): Colin Young Kristy Hopkins DUE DATE: 01 Jul 2020 FREQUENCY: The first Day of every 12 months
TREATMENT MC00038 Arrange payment plans for Rates - Setup payment arrangement with Rate payer Process which ensures rate debts are collected / managed effectively	SIGNOFF(S): Codey Redmond Vicki Schwidden Colin Young DUE DATE: FREQUENCY: Once
TREATMENT MC00039 Develop Annual Budgets - Send Email Ensure budget process is managed effectively	SIGNOFF(S): Colin Young Kristy Hopkins DUE DATE: 31 Jul 2020 FREQUENCY: The last Day of every 12 months
TREATMENT MC00040 Manage Rate Recovery - Confirm rates outstanding Manage recovery of rated	SIGNOFF(S): Codey Redmond Vicki Schwidden DUE DATE: 01 Jul 2020 FREQUENCY: The first Day of every 12 months

Audit Committee Meeting Minutes
9 October 2019



RESIDUAL
6.0
MODERATE

INHERENT
20.0

R00001

CORPORATE SERVICES, COMPLIANCE - LEGISLATIVE

Failure to fulfil statutory, regulatory or compliance requirements

Council is exposed to reputation damage and serious breaches due to a failure to comply with legislative and compliance requirements

OWNER Colin Young
CREATED 08/04/2019 06:46:49

LIKELIHOOD Almost Certain
SEVERITY Major
CONTROL EFFECTIVENESS Strong

TREATMENT MC00002	Local Government is responsible for complying with a wide range of legislative requirements, to mitigate this risk a compliance calendar has been developed and will be audited monthly by the Governance officer. Failure to comply with legislative requirements could result in a range of outcomes including a Department of Local Government Inquiry	SIGNOFF(S): Cheryl Greenough DUE DATE: 14 Oct 2019 FREQUENCY: 14th day of every month
TREATMENT MC00007	Manage Inductions - Conduct New Employee Induction All new employees are provided with adequate inductions	CHANGE(S) PENDING SIGNOFF(S): Bev Jones Helen Zahra DUE DATE: FREQUENCY: Fri every week
TREATMENT MC00009	Monthly random internal audit of five (5) purchases to be performed to ensure compliance with purchasing requirements.	SIGNOFF(S): Cheryl Greenough DUE DATE: 14 Oct 2019 FREQUENCY: 14th day of every month
TREATMENT MC00058	Organisational Compliance Calendar in place and reviewed by Executive Management Group	SIGNOFF(S): Cheryl Greenough DUE DATE: 31 Mar 2020 FREQUENCY: The first Day of every 12 months
TREATMENT MC00059	Induction & Training provided to elected members	SIGNOFF(S): Alysha McCall DUE DATE: 30 Nov 2019 FREQUENCY: The last Day of every 24 months
TREATMENT MC00060	Complete Annual Compliance Return (Dept Local Government)	SIGNOFF(S): Cheryl Greenough DUE DATE: 29 Feb 2020 FREQUENCY: The last Day of every 12 months

UNCOMPLETED

Audit Committee Meeting Minutes
9 October 2019



RESIDUAL
6.0
MODERATE
INHERENT
20.0

RD00032

DEVELOPMENT SERVICES, HEALTH & SAFETY

Inadequate Organisation and Community Emergency Management

Failure to adequately conduct Prevention, Preparation, Response and Recovery (PPRR) in the organisation structure and community elements, inclusive of the management of all emergencies. This includes:

- Lack of (or inadequate) emergency response plans.
- Lack of training to specific individuals or availability of appropriate emergency response.
- Failure in command and control functions as a result of incorrect initial assessment or untimely awareness of incident.
- Inadequacies in environmental awareness and monitoring of fuel loads, curing rates etc

(References: AS 3745; AS 1851; AIMS 4 Management Principles)

OWNER Chadd Hunt
CREATED 02/07/2019 05:42:30
LIKELIHOOD Likely
SEVERITY Extreme
CONTROL EFFECTIVENESS Strong

TREATMENT MC00077

Functioning Local Emergency Management Committee, which meets quarterly

SIGNOFF(S): Brendon Rutter
Chadd Hunt

DUE DATE: 31 Oct 2019
FREQUENCY: The last Day of every 3 months

TREATMENT MC00078

Conduct at least 1 Emergency Management training exercise per year

SIGNOFF(S): Brendon Rutter
Chadd Hunt

DUE DATE: 30 Sep 2019
FREQUENCY: The last Day of every 12 months

TREATMENT MC00079

Conduct inductions for Bush Fire Brigade Volunteer Members Annually

SIGNOFF(S): Brendon Rutter
Chadd Hunt

DUE DATE: 01 Oct 2019
FREQUENCY: The first Day of every 11 months

TREATMENT MC00080

Review Risk to Resources Document

SIGNOFF(S): Brendon Rutter
Chadd Hunt

DUE DATE: 30 Sep 2019
FREQUENCY: The last Day of every 24 months

RESIDUAL
4.8
MODERATE
INHERENT
16.0

RD00036

AMP - TRANSPORT, HEALTH & SAFETY

Transport Assets not routinely inspected

No formal safety & maintenance inspection procedures exist

OWNER Paul Kher
CREATED 15/07/2019 08:35:25
LIKELIHOOD Likely
SEVERITY Major
CONTROL EFFECTIVENESS Strong

TREATMENT MC00088

Safety and maintenance inspection procedures developed

SIGNOFF(S): Paul Kher

DUE DATE: 31 Oct 2019
FREQUENCY: The first Day of every 112 months

Audit Committee Meeting Minutes
9 October 2019



RESIDUAL 4.8 MODERATE	AMP - TRANSPORT, ENVIRONMENTAL - BUILT	TREATMENT MC00089	SIGNOFF(S): Jason Whiteaker
	Lack of capital project evaluation procedure Shire does not have a capital project evaluation procedure aligned to the Community Strategic Plan	Project evaluation procedure in place and utilised	DUE DATE: 29 Nov 2019
INHERENT 16.0 R00039	OWNER Jason Whiteaker CREATED 15/07/2019 08:54:13		FREQUENCY: The first Day of every 24 months
	LIKELIHOOD Likely SEVERITY Major CONTROL EFFECTIVENESS Strong		

RESIDUAL 4.8 MODERATE	AMP - BUILDINGS, FINANCIAL - STRATEGIC	TREATMENT MC00089	SIGNOFF(S): Jason Whiteaker
	Capital projects can not be prioritised against the strategic community plan Council is unable to assess projects and make determinations around priorities, based on any framework or decision criteria.	Project evaluation procedure in place and utilised	DUE DATE: 29 Nov 2019
INHERENT 16.0 R00043	OWNER Jason Whiteaker CREATED 16/07/2019 03:33:15		FREQUENCY: The first Day of every 24 months
	LIKELIHOOD Likely SEVERITY Major CONTROL EFFECTIVENESS Strong		

UNCONFIRMED

Audit Committee Meeting Minutes
9 October 2019



RESIDUAL
4.8
MODERATE
INHERENT
16.0

R00008

CHIEF EXECUTIVES OFFICE, REPUTATION - COMMUNITY

Not meeting community expectations

Community service expectations are not as a result of a failure to provide expected levels of service, events and benefit to the community. This includes where precedents have set Community perceptions or where services are generally expected.

OWNER Jason Whiteaker

CREATED 09/05/2019 05:56:25

LIKELIHOOD Likely

SEVERITY Major

CONTROL EFFECTIVENESS Strong

TREATMENT MC00004

Review Corporate Business Plan annually to ensure reflects strategic community plan

SIGNOFF(S): Jason Whiteaker

DUE DATE: 30 Jun 2020

FREQUENCY: The last Day of every 12 months

TREATMENT MC00012

Undertake community surveying every two years focusing on community perception of service delivery

SIGNOFF(S): Jason Whiteaker

DUE DATE: 31 Aug 2021

FREQUENCY: The last Day of every 24 months

TREATMENT MC00013

Manage Customer Requests - Receive Request Ensuring that the organisation captures and responds appropriately to community and internal requests for works or services

SIGNOFF(S): Jason Whiteaker
Alysha McCall

DUE DATE:

FREQUENCY: Once

RESIDUAL
4.8
MODERATE
INHERENT
16.0

R00013

CORPORATE SERVICES, ENGINEERING SERVICES, ENVIRONMENTAL - BUILT, FINANCIAL - STRATEGIC, SERVICE INTERRUPTION

Inadequate Asset Management Practices

Failure or reduction in service of infrastructure assets, plant, equipment or machinery. These include fleet assets in addition to community use based assets including playgrounds, boat ramps and other maintenance based assets. Areas included in the scope are:

- Inadequate design (not fit for purpose).
- Ineffective usage (down time)
- Outputs not meeting expectations
- Inadequate maintenance activities.
- Inadequate or unsafe modifications.

It does not include issues with the inappropriate use of the Plant, Equipment or Machinery. Refer Misconduct.

OWNER Clinton Kleynhans

CREATED 24/05/2019 06:29:02

LIKELIHOOD Likely

SEVERITY Major

CONTROL EFFECTIVENESS Strong

TREATMENT MC00018

Up to date and accurate transport management plan in place

SIGNOFF(S): Clinton Kleynhans
Colin Young

DUE DATE: 16 Feb 2021

FREQUENCY: The first Day of every 24 months

TREATMENT MC00019

Up to date and accurate building asset management plan in place

SIGNOFF(S): Clinton Kleynhans
Colin Young

DUE DATE: 01 Jun 2021

FREQUENCY: The first Day of every 24 months

TREATMENT MC00020

Up to date and accurate parks & reserves asset management plan in place

SIGNOFF(S): Clinton Kleynhans
Colin Young

DUE DATE: 01 Sep 2021

FREQUENCY: The first Day of every 24 months

TREATMENT MC00021

Long Term Financial Plan aligned to asset management plans

SIGNOFF(S): Colin Young

DUE DATE: 26 Dec 2019

FREQUENCY: The first Day of every 12 months

Audit Committee Meeting Minutes
9 October 2019



RESIDUAL
4.8
MODERATE

INHERENT
16.0
R00022

CHIEF EXECUTIVES OFFICE, HEALTH & SAFETY - OCCUPATIONAL

Inadequate safety and security practices

Non-compliance with the Occupation Safety & Health Act, associated regulations and standards. It is also the inability to ensure the physical security requirements of staff, contractors and visitors. Other considerations are:

- Inadequate Policy, Frameworks, Systems and Structure to prevent the injury of visitors, staff, contractors and/or tenants.
- Inadequate Organisational Emergency Management requirements (evacuation diagrams, drills, wardens etc).
- Inadequate security protection measures in place for buildings, depots and other places of work (vehicle, community etc).
- Public Liability Claims, due to negligence or personal injury.
- Employee Liability Claims due to negligence or personal injury.
- Inadequate or unsafe modifications to plant & equipment

OWNER Jason Whiteaker
CREATED 01/07/2019 06:46:30

LIKELIHOOD Likely
SEVERITY Major
CONTROL EFFECTIVENESS Strong

TREATMENT MC00041

Undertake OHS Audit

SIGNOFF(S): Bev Jones
DUE DATE: 01 Sep 2021
FREQUENCY: The first Day of every 24 months

TREATMENT MC00042

Implement recommendations from OHS Audit & Report to Audit & Risk Committee

NON-COMPLIANT
SIGNOFF(S): Bev Jones
DUE DATE: 30 Sep 2019
FREQUENCY: The last Day of every 4 months

TREATMENT MC00043

OHS Committee Meeting Regularly

SIGNOFF(S): Bev Jones
DUE DATE: 31 Dec 2019
FREQUENCY: The last Day of every 3 months

TREATMENT MC00044

Toolbox meetings occurring and discussing safety (attach minutes/notes to sign off)

SIGNOFF(S): Clinton Kleynhans
DUE DATE: 31 Oct 2019
FREQUENCY: The last Day of every month

TREATMENT MC00045

Senior Management Meeting (where the OSH system is reviewed and KPI's are measured as an agenda item)

SIGNOFF(S): Jason Whiteaker
DUE DATE: 30 Sep 2019
FREQUENCY: The last Day of every 6 months

TREATMENT MC00046

OHS Policy Framework in place and reviewed

NON-COMPLIANT
SIGNOFF(S): Bev Jones
DUE DATE: 30 Aug 2019
FREQUENCY: The last Day of every 12 months

UNCOMPLETED

Audit Committee Meeting Minutes
9 October 2019



RESIDUAL 4.8
MODERATE

INHERENT 16.0
R00020

CORPORATE SERVICES, FINANCIAL - OPERATIONAL, FINANCIAL - STRATEGIC

External Theft & Fraud (inc. Cyber Crime)
Loss of funds, assets, data or unauthorised access, (whether attempts or successful) by external parties, through any means (including electronic), for the purposes of;

- Fraud – benefit or gain by deceit
- Malicious Damage – hacking, deleting, breaking or reducing the integrity or performance of systems
- Theft – stealing of data, assets or information (no deceit)

OWNER Colin Young
CREATED 01/07/2019 06:32:52

LIKELIHOOD Likely
SEVERITY Major
CONTROL EFFECTIVENESS Strong

RESIDUAL 4.5
MODERATE

INHERENT 15.0
R00017

DEVELOPMENT SERVICES, HEALTH & SAFETY - PUBLIC

Inadequate Organisation and Community Emergency Management
Failure to adequately conduct Prevention, Preparation, Response and Recovery (PPRR) in the organisation structure and community elements, inclusive of the management of all emergencies. This includes;

- Lack of (or inadequate) emergency response plans.
- Lack of training to specific individuals or availability of appropriate emergency response.
- Failure in command and control functions as a result of incorrect initial assessment or untimely awareness of incident.
- Inadequacies in environmental awareness and monitoring of fuel loads, curing rates etc.

(References: AS 3745; AS 1851; AIIMS 4 Management Principles)

OWNER Chadd Hunt
CREATED 19/08/2019 00:51:12

LIKELIHOOD Possible
SEVERITY Extreme
CONTROL EFFECTIVENESS Strong

TREATMENT MC00027	SIGNOFF(S):	Brendon Rutter
Establishment of a 'functional' Local Emergency Management Committee, which meets six monthly	DUE DATE:	30 Sep 2019
	FREQUENCY:	The last Day of every 6 months
TREATMENT MC00028	SIGNOFF(S):	Brendon Rutter Chadd Hunt
Current Local Emergency Management Arrangements & Recovery Plan	DUE DATE:	30 Nov 2020
	FREQUENCY:	The first Day of every 24 months
TREATMENT MC00029	SIGNOFF(S):	Brendon Rutter Chadd Hunt
Run annual emergency management exercise	DUE DATE:	29 Nov 2019
	FREQUENCY:	The first Day of every 12 months
TREATMENT MC00030	SIGNOFF(S):	Brendon Rutter Chadd Hunt
Bush fire Risk Management Plan in Place	DUE DATE:	30 Sep 2019
	FREQUENCY:	The first Day of every 12 months
TREATMENT MC00031	SIGNOFF(S):	Brendon Rutter Chadd Hunt
Fuel Loads risk register in place	DUE DATE:	30 Sep 2019
	FREQUENCY:	The last Day of every 12 months

Audit Committee Meeting Minutes
9 October 2019



RESIDUAL
3.6
LOW

INHERENT
12.0

R00002

CHIEF EXECUTIVES OFFICE, STRATEGIC - ORGANISATIONAL

Inappropriate Organisational Structure
Unable to achieve organisational objectives as the Organisation is not structured appropriately

OWNER Jason Whiteaker
CREATED 09/04/2019 03:32:51

LIKELIHOOD Likely
SEVERITY Medium
CONTROL EFFECTIVENESS Strong

TREATMENT MC00003	SIGNOFF(S): Jason Whiteaker
Review Strategic Community Plan every two years (desktop) and four years (major). Reviews to coincide with new Council being elected	DUE DATE: 18 Dec 2019
	FREQUENCY: The last Day of every 24 months
TREATMENT MC00004	SIGNOFF(S): Jason Whiteaker
Review Corporate Business Plan annually to ensure reflects strategic community plan	DUE DATE: 30 Jun 2020
	FREQUENCY: The last Day of every 12 months
TREATMENT MC00005	NON-COMPLIANT
Review Human Resource Plan to ensure it is reflective of strategic community plan	SIGNOFF(S): Bev Jones
	DUE DATE: 15 May 2019
	FREQUENCY: The last Day of every 12 months
TREATMENT MC00006	SIGNOFF(S): Jason Whiteaker
Corporate Business Plan clearly articulates how organisational objectives will be achieved	DUE DATE: 30 Jun 2020
	FREQUENCY: The last Day of every 12 months

RESIDUAL
3.6
LOW

INHERENT
12.0

R00027

MAJOR PROJECT - AQUATIC FACILITY, FINANCIAL - OPERATIONAL, HEALTH & SAFETY, PROPERTY - LIABILITY, REPUTATION - COMMUNITY, STRATEGIC - COMMUNITY

Ineffective Project Management
Project not managed effectively

OWNER Jason Whiteaker
CREATED 01/07/2019 08:29:57

LIKELIHOOD Possible
SEVERITY Major
CONTROL EFFECTIVENESS Strong

TREATMENT MC00053	SIGNOFF(S): Jason Whiteaker
Project management framework in place, providing parameters for staff to operate within	DUE DATE: 31 Jul 2020
	FREQUENCY: The last Day of every 12 months
TREATMENT MC00054	SIGNOFF(S): Alysha McCall
Major Project status reporting to Council (through monthly elected member report)	DUE DATE: 07 Oct 2019
	FREQUENCY: 7th day of every month
TREATMENT MC00064	SIGNOFF(S): Jason Whiteaker
Independent Project Superintendent appointed with requisite skills to acknowledge scale and complexity of this project	DUE DATE: Once
	FREQUENCY: Once
TREATMENT MC00067	SIGNOFF(S): Jason Whiteaker
Construction project progress reports to be provided	DUE DATE: 05 Oct 2019
	FREQUENCY: 5th day of every month

Audit Committee Meeting Minutes
9 October 2019



TREATMENT MC00068 Project Superintendent (Donovan Payne) reports to be provided monthly	OVERDUE SIGNOFF(S): Jason Whiteaker DUE DATE: 19 Sep 2019 FREQUENCY: 19th day of every month
TREATMENT MC00069 Financial variations to be signed off by Project Manager	SIGNOFF(S): Jason Whiteaker DUE DATE: 05 Oct 2019 FREQUENCY: 5th day of every month
TREATMENT MC00070 All request for information and clarification to be signed off / cited by Council Project Manager	SIGNOFF(S): Jason Whiteaker DUE DATE: 05 Oct 2019 FREQUENCY: 5th day of every month
TREATMENT MC00071 Project assessment / evaluation to be undertaken at completion and reported to audit committee	SIGNOFF(S): Jason Whiteaker DUE DATE: 16 Feb 2020 FREQUENCY: Once
TREATMENT MC00074 Project time delays to be signed off in accordance with contract	SIGNOFF(S): Jason Whiteaker DUE DATE: 05 Oct 2019 FREQUENCY: 5th day of every month

RESIDUAL
3.6
LOW

INHERENT
12.0

R00028

MAJOR PROJECT - AQUATIC FACILITY, HEALTH & SAFETY - OCCUPATIONAL
Insufficient OHS in place for project
Contractor has insufficient systems, processes and practices in place to manage site OHS effectively

OWNER Jason Whiteaker
CREATED 01/07/2019 08:33:46

LIKELIHOOD Possible
SEVERITY Major
CONTROL EFFECTIVENESS Strong

TREATMENT MC00085 OHS report required from contractor, including details of site their own OHS site inspections	SIGNOFF(S): Jason Whiteaker DUE DATE: 05 Oct 2019 FREQUENCY: 5th day of every month
--	---

Audit Committee Meeting Minutes
9 October 2019



RESIDUAL 3.6 LOW	MAJOR PROJECT - AQUATIC FACILITY, COMPLIANCE - LEGISLATIVE Inadequate Construction Contract Construction contract not adequate which exposes Council to contract risk through the construction phase	TREATMENT MC00066 Contract in place, signed and vetted by Legal Firm	SIGNOFF(S): Jason Whiteaker DUE DATE: FREQUENCY: Once
	INHERENT 12.0 R00029	OWNER Jason Whiteaker CREATED 01/07/2019 08:37:46 LIKELIHOOD Possible SEVERITY Major CONTROL EFFECTIVENESS Strong	
RESIDUAL 3.6 LOW	MAJOR PROJECT - AQUATIC FACILITY, FINANCIAL - OPERATIONAL Grant partners milestones not met Funding organisations require regular reporting, failure to do so may result in withdrawal of funds	TREATMENT MC00072 Department of Sport & Recreation milestone reports provided	SIGNOFF(S): Jason Whiteaker DUE DATE: 31 Dec 2019 FREQUENCY: The last Day of every 5 months
	INHERENT 12.0 R00030	OWNER Jason Whiteaker CREATED 01/07/2019 08:46:18 LIKELIHOOD Possible SEVERITY Major CONTROL EFFECTIVENESS Strong	TREATMENT MC00073 Federal Building Better Regions Fund milestone reporting

UNCONFIRMED

Audit Committee Meeting Minutes
9 October 2019



RESIDUAL 3.6 LOW INHERENT 12.0 R00031	GENERAL, REPUTATION - COMMUNITY Providing inaccurate advice / information to stakeholders Incomplete, inadequate or inaccuracies in advisory activities to customers or internal staff. This could be caused by using unqualified, or inexperienced staff, however it does not include instances relating to Misconduct.	TREATMENT MC00007 Manage Inductions - Conduct New Employee Induction All new employees are provided with adequate inductions	CHANGE(S) PENDING SIGNOFF(S): Bev Jones Helen Zahra DUE DATE: FREQUENCY: Fri every week
	Examples include: • incorrect planning, development or building advice, • incorrect health or environmental advice • inconsistent messages or responses from Customer Service Staff • any advice that is not consistent with legislative requirements, local laws or policies. OWNER Jason Whiteaker CREATED 02/07/2019 05:27:54 LIKELIHOOD Likely SEVERITY Medium CONTROL EFFECTIVENESS Strong	TREATMENT MC00013 Manage Customer Requests - Receive Request Ensuring that the organisation captures and responds appropriately to community and internal requests for works or services	SIGNOFF(S): Jason Whiteaker Alysha McCall DUE DATE: FREQUENCY: Once
RESIDUAL 3.6 LOW INHERENT 12.0 R00044	AMP - BUILDINGS, FINANCIAL - OPERATIONAL Maintenance not planned Planned Maintenance & operation schedules, with budgets, do not exist, resulting in long term financial costs and asset deterioration	TREATMENT MC00051 Manage Staff Training - Identify Training Needs Ensure staff training needs are identified and met	CHANGE(S) PENDING SIGNOFF(S): Bev Jones DUE DATE: 31 Oct 2019 FREQUENCY: The last Day of every 12 months
	OWNER Shane Moorhead CREATED 16/07/2019 03:36:36 LIKELIHOOD Possible SEVERITY Major CONTROL EFFECTIVENESS Strong	TREATMENT MC00019 Up to date and accurate building asset management plan in place	SIGNOFF(S): Clinton Kleynhans Colin Young DUE DATE: 01 Jun 2021 FREQUENCY: The first Day of every 24 months
		TREATMENT MC00035 Annual Budget adopted and aligned with long term financial plan	SIGNOFF(S): Colin Young DUE DATE: 31 Jul 2020 FREQUENCY: The last Day of every 12 months

Audit Committee Meeting Minutes
9 October 2019



RESIDUAL
3.6
LOW

INHERENT
12.0

R00045

AMP - BUILDINGS, FINANCIAL - STRATEGIC

Financial performance indicators not met
The asset class does not meet the established financial performance parameters, resulting in an indication of asset sustainability

OWNER Clinton Kleynhans
CREATED 16/07/2019 03:38:59

LIKELIHOOD Likely
SEVERITY Medium
CONTROL EFFECTIVENESS Strong

TREATMENT MC00019
Up to date and accurate building asset management plan in place

SIGNOFF(S): Clinton Kleynhans
Colin Young
DUE DATE: 01 Jun 2021
FREQUENCY: The first Day of every 24 months

TREATMENT MC00021
Long Term Financial Plan aligned to asset management plans

SIGNOFF(S): Colin Young
DUE DATE: 26 Dec 2019
FREQUENCY: The first Day of every 12 months

TREATMENT MC00090
Revaluations of Council Building Assets (Fair Value)

SIGNOFF(S): Colin Young
DUE DATE: 04 Oct 2021
FREQUENCY: The first Day of every 60 months

TREATMENT MC00091
Revaluations of Council Transport Infrastructure Assets (Fair Value)

SIGNOFF(S): Colin Young
DUE DATE: 03 Oct 2022
FREQUENCY: The first Day of every 60 months

RESIDUAL
3.6
LOW

INHERENT
12.0

R00046

MAJOR PROJECT - SALE OF 239 YILGARN AVENUE, COMPLIANCE - LEGISLATIVE, FINANCIAL - STRATEGIC

Contract Requirements not satisfied
Sale of land does not proceed as a result of non compliance with contract requirements

OWNER Jason Whiteaker
CREATED 29/08/2019 08:50:17

LIKELIHOOD Possible
SEVERITY Major
CONTROL EFFECTIVENESS Strong

TREATMENT MC00034
The Buyer shall submit a Development Application within six calendar months of the contract date

SIGNOFF(S): Jason Whiteaker
DUE DATE:
FREQUENCY: Once

UNCONFIRMED

Audit Committee Meeting Minutes
9 October 2019



RESIDUAL 3.6 LOW INHERENT 12.0 R00041	AMP - BUILDINGS, ENVIRONMENTAL - BUILT, HEALTH & SAFETY Condition of buildings is unknown Council is unclear as to the condition of its building assets and therefore unable to make informed decisions, resulting in poor building condition and building safety concerns	TREATMENT MC00019 Up to date and accurate building asset management plan in place	SIGNOFF(S): Clinton Kleynhans Colin Young DUE DATE: 01 Jun 2021 FREQUENCY: The first Day of every 24 months
	OWNER Shane Moorhead CREATED 16/07/2019 03:26:43 LIKELIHOOD Possible SEVERITY Major CONTROL EFFECTIVENESS Strong	TREATMENT MC00090 Revaluations of Council Building Assets (Fair Value)	SIGNOFF(S): Colin Young DUE DATE: 04 Oct 2021 FREQUENCY: The first Day of every 60 months
		TREATMENT MC00093 Develop and maintain medium term building maintenance program to ensure future costs are understood	SIGNOFF(S): Shane Moorhead DUE DATE: 22 Nov 2019 FREQUENCY: The first Day of every 12 months
RESIDUAL 3.6 LOW INHERENT 12.0 R00042	AMP - BUILDINGS, FINANCIAL - OPERATIONAL Future financial requirements for buildings unknown Council fails to understand and plan for future building maintenance / expansion requirements	TREATMENT MC00019 Up to date and accurate building asset management plan in place	SIGNOFF(S): Clinton Kleynhans Colin Young DUE DATE: 01 Jun 2021 FREQUENCY: The first Day of every 24 months
	OWNER Clinton Kleynhans CREATED 16/07/2019 03:28:36 LIKELIHOOD Possible SEVERITY Major CONTROL EFFECTIVENESS Strong	TREATMENT MC00021 Long Term Financial Plan aligned to asset management plans	SIGNOFF(S): Colin Young DUE DATE: 26 Dec 2019 FREQUENCY: The first Day of every 12 months
		TREATMENT MC00034 Long Term Financial Plan in Place	SIGNOFF(S): Colin Young DUE DATE: 01 Jul 2020 FREQUENCY: The first Day of every 12 months
		TREATMENT MC00035 Annual Budget adopted and aligned with long term financial plan	SIGNOFF(S): Colin Young DUE DATE: 31 Jul 2020 FREQUENCY: The last Day of every 12 months

Audit Committee Meeting Minutes
9 October 2019



RESIDUAL 3.6 LOW INHERENT 12.0 R00037	AMP - TRANSPORT, ENVIRONMENTAL - BUILT Asset Inventories inaccurate Asset inventories are not up to date and therefore inaccurate resulting in poor decision making	TREATMENT MC00018 Up to date and accurate transport management plan in place	SIGNOFF(S): Clinton Kleynhans Colin Young DUE DATE: 16 Feb 2021 FREQUENCY: The first Day of every 24 months
	OWNER Paul Kher CREATED 15/07/2019 08:40:29 LIKELIHOOD Likely SEVERITY Medium CONTROL EFFECTIVENESS Strong	TREATMENT MC00019 Up to date and accurate building asset management plan in place	SIGNOFF(S): Clinton Kleynhans Colin Young DUE DATE: 01 Jun 2021 FREQUENCY: The first Day of every 24 months
		TREATMENT MC00020 Up to date and accurate parks & reserves asset management plan in place	SIGNOFF(S): Clinton Kleynhans Colin Young DUE DATE: 01 Sep 2021 FREQUENCY: The first Day of every 24 months
RESIDUAL 3.6 LOW INHERENT 12.0 R00038	AMP - TRANSPORT, ENVIRONMENTAL - BUILT Inaccurate Asset Valuations Valuations are carried out, however inaccurate resulting in impact on Council decision making and financial ratios	TREATMENT MC00090 Revaluations of Council Building Assets (Fair Value)	SIGNOFF(S): Colin Young DUE DATE: 04 Oct 2021 FREQUENCY: The first Day of every 60 months
	OWNER Colin Young CREATED 15/07/2019 08:47:14 LIKELIHOOD Possible SEVERITY Major CONTROL EFFECTIVENESS Strong	TREATMENT MC00091 Revaluations of Council Transport Infrastructure Assets (Fair Value)	SIGNOFF(S): Colin Young DUE DATE: 03 Oct 2022 FREQUENCY: The first Day of every 60 months
		TREATMENT MC00092 Revaluation of Council Plant & Equipment	SIGNOFF(S): Colin Young DUE DATE: 05 Oct 2020 FREQUENCY: The first Day of every 60 months

Audit Committee Meeting Minutes
9 October 2019



RESIDUAL
3.6
LOW

INHERENT
12.0

R00033

GENERAL REPUTATION - COMMUNITY

Errors, Omissions & Delays

Errors, omissions or delays in operational activities as a result of unintentional errors or failure to follow due process or potentially inadequate resources. This includes instances of:

- Human errors, incorrect or incomplete processing
- Inaccurate recording, maintenance, testing and / or reconciliation of data.
- Errors or inadequacies in model methodology, design, calculation or implementation of models.

This may result in incomplete or inaccurate information.

Consequences include;

- Inaccurate data being used for management decision making and reporting.
- Delays in service to customers
- Inaccurate data provided to customers

This excludes process failures caused by inadequate / incomplete procedural documentation - refer "Inadequate Document Management Processes".

OWNER Jason Whiteaker

CREATED 02/07/2019 05:56:01

LIKELIHOOD Likely

SEVERITY Medium

CONTROL EFFECTIVENESS Strong

TREATMENT MC00002

Local Government is responsible for complying with a wide range of legislative requirements, to mitigate this risk a compliance calendar has been developed and will be audited monthly by the Governance officer. Failure to comply with legislative requirements could result in a range of outcomes including a Department of Local Government Inquiry

SIGNOFF(S): Cheryl Greenough
DUE DATE: 14 Oct 2019
FREQUENCY: 14th day of every month

TREATMENT MC00007

Manage Inductions - Conduct New Employee Induction
All new employees are provided with adequate inductions

CHANGE(S) PENDING
SIGNOFF(S): Bev Jones
Helen Zahra

DUE DATE:
FREQUENCY: Fri every week

TREATMENT MC00009

Monthly random internal audit of five (5) purchases to be performed to ensure compliance with purchasing requirements.

SIGNOFF(S): Cheryl Greenough
DUE DATE: 14 Oct 2019
FREQUENCY: 14th day of every month

TREATMENT MC00083

Manage Inductions - Conduct New Employee Induction
Ensure staff are inducted into the organisation

SIGNOFF(S): Bev Jones
DUE DATE: 01 Oct 2020
FREQUENCY: The first Day of every 12 months

TREATMENT MC00084

Have critical processes mapped to assist staff eliminate errors, omissions and delays (wastage)

SIGNOFF(S): Alysha McCall
DUE DATE: 31 Dec 2019
FREQUENCY: The first Day of every 12 months

Audit Committee Meeting Minutes
9 October 2019



<p>RESIDUAL 3.6 LOW</p> <p>INHERENT 12.0</p> <p>R00034</p>	<p>COMMUNITY SERVICES, COMPLIANCE - POLICY, REPUTATION - COMMUNITY</p> <p>Ineffective Management of Facilities / Venues / Events</p> <p>Failure to effectively manage the day to day operations of facilities, venues and / or events. This includes:</p> <ul style="list-style-type: none"> Inadequate procedures in place to manage the quality or availability. Ineffective signage Booking issues Financial interactions with hirers / users Oversight / provision of peripheral services (eg. cleaning / maintenance) <p>OWNER Ross Rayson CREATED 02/07/2019 06:05:05</p> <p>LIKELIHOOD Likely SEVERITY Medium CONTROL EFFECTIVENESS Strong</p>	<p>TREATMENT MC00085</p> <p>Manage Facilities & Bookings - Receive enquiry and determine which Department is responsible for administering the booking Process for managing bookings to ensure no duplication</p>	<p>SIGNOFF(S): Jack Little DUE DATE: 30 Sep 2019 FREQUENCY: The first Day of every 12 months</p>
<p>RESIDUAL 3.6 LOW</p> <p>INHERENT 12.0</p> <p>R00035</p>	<p>CHIEF EXECUTIVES OFFICE, COMPLIANCE - LEGISLATIVE, REPUTATION - COMMUNITY, REPUTATION - INDUSTRY</p> <p>Misconduct</p> <p>Intentional activities in excess of authority granted to an employee, which circumvent endorsed policies, procedures or delegated authority. This would include instances of:</p> <ul style="list-style-type: none"> Relevant authorisations not obtained. Distributing confidential information. Accessing systems and / or applications without correct authority to do so. Misrepresenting data in reports. Theft by an employee Collusion between Internal & External parties <p>This does not include instances where it was not an intentional breach - refer Errors, Omissions or delays in transaction processing, or Inaccurate Advice.</p> <p>OWNER Jason Whiteaker CREATED 02/07/2019 06:09:25</p> <p>LIKELIHOOD Possible SEVERITY Major CONTROL EFFECTIVENESS Strong</p>	<p>TREATMENT MC00007</p> <p>Manage Inductions - Conduct New Employee Induction All new employees are provided with adequate inductions</p>	<p>CHANGE(S) PENDING</p> <p>SIGNOFF(S): Bev Jones Helen Zahra DUE DATE: FREQUENCY: Fri every week</p>
		<p>TREATMENT MC00059</p> <p>Induction & Training provided to elected members</p>	<p>SIGNOFF(S): Alysha McCall DUE DATE: 30 Nov 2019 FREQUENCY: The last Day of every 24 months</p>
		<p>TREATMENT MC00086</p> <p>Manage Inductions - Conduct New Employee Induction Induction of new employees into the organisation assists in creating an expectation in terms of what is required</p>	<p>SIGNOFF(S): Bev Jones DUE DATE: 01 Sep 2020 FREQUENCY: The first Day of every 12 months</p>
		<p>TREATMENT MC00087</p> <p>Manage Purchasing - Request approval Process minimises opportunity for misconduct</p>	<p>SIGNOFF(S): Colin Young Kristy Hopkins DUE DATE: 31 Oct 2019 FREQUENCY: The first Day of every 12 months</p>

Audit Committee Meeting Minutes
 9 October 2019



RESIDUAL
 2.7
 LOW

INHERENT
 9.0

R00024

CHIEF EXECUTIVES OFFICE, COMPLIANCE - POLICY, FINANCIAL - OPERATIONAL, HEALTH & SAFETY - OCCUPATIONAL

Inadequate Project Management
 Inadequate analysis, design, delivery and / or status reporting of change initiatives, resulting in additional expenses, time requirements or scope changes. This includes:

- Inadequate Change Management Framework to manage and monitor change activities.
- Inadequate understanding of the impact of project change on the business.
- Failures in the transition of projects into standard operations.

OWNER Jason Whiteaker
 CREATED 01/07/2019 07:20:45

LIKELIHOOD Possible
 SEVERITY Medium
 CONTROL EFFECTIVENESS Strong

TREATMENT MC00053	Project management framework in place, providing parameters for staff to operate within	SIGNOFF(S): Jason Whiteaker DUE DATE: 31 Jul 2020 FREQUENCY: The last Day of every 12 months
TREATMENT MC00054	Major Project status reporting to Council (through monthly elected member report)	SIGNOFF(S): Alysha McCall DUE DATE: 07 Oct 2019 FREQUENCY: 7th day of every month
TREATMENT MC00055	Internal audit of project and major project (as defined by corporate business plan) management framework compliance.	SIGNOFF(S): Jason Whiteaker DUE DATE: 31 May 2020 FREQUENCY: The last Day of every 12 months
TREATMENT MC00056	Identification of project classification in accordance with corporate business plan. Each Executive Manager to review their budget and identify which submit list of projects and their classification (not required for anything identified as works in accordance with corporate business plan)	SIGNOFF(S): Jason Whiteaker Chadd Hunt Colin Young Ross Rayson Clinton Kleynhans DUE DATE: 31 Aug 2020 FREQUENCY: The last Day of every 12 months
TREATMENT MC00057	Manage Major Projects - Project Implementation Provides process for managing projects	SIGNOFF(S): Clinton Kleynhans Sue Connell DUE DATE: 30 Sep 2020 FREQUENCY: The last Day of every 12 months

Audit Committee Meeting Minutes
9 October 2019



RESIDUAL
2.7
LOW
INHERENT
9.0
R00025

CHIEF EXECUTIVES OFFICE, COMMUNITY SERVICES, CORPORATE SERVICES, DEVELOPMENT SERVICES, ENGINEERING SERVICES, FINANCIAL - OPERATIONAL, HEALTH & SAFETY - OCCUPATIONAL, SERVICE INTERRUPTION

Inadequate Supplier / Contract Management

Inadequate management of External Suppliers, Contractors, IT Vendors or Consultants engaged for core operations. This includes issues that arise from the ongoing supply of services or failures in contract management & monitoring processes. This also includes:

- Concentration issues
- Vendor sustainability

It does not include failures in the tender process; refer 'Inadequate Procurement, Disposal or Tender Practices'.

OWNER Sue Connell

CREATED 01/07/2019 07:54:58

LIKELIHOOD Possible

SEVERITY Medium

CONTROL EFFECTIVENESS Strong

UNCONFIRMED

Audit Committee Meeting Minutes
9 October 2019



RESIDUAL
2.7
LOW

INHERENT
9.0

R00003

CHIEF EXECUTIVES OFFICE, STRATEGIC - ORGANISATIONAL

Ineffective People Management / Employment Practices

Failure to effectively manage and lead human resources (full/part time, casuals, temporary and volunteers). This includes not having an effective Human Resources Framework in addition to not having appropriately qualified or experienced people in the right roles or not having sufficient staff numbers to achieve objectives. Other areas in this risk theme to consider are;

- Breaching employee regulations (excluding OH&S).
- Discrimination, Harassment & Bullying in the workplace.
- Poor employee wellbeing (causing stress)
- Key person dependencies without effective succession planning in place.
- Induction issues.
- Terminations (including any tribunal issues).
- Industrial activity.

Care should be taken when considering insufficient staff numbers as the underlying issue could be a process inefficiency.

OWNER Jason Whiteaker
CREATED 06/05/2019 05:23:01

LIKELIHOOD Possible
SEVERITY Medium
CONTROL EFFECTIVENESS Strong

TREATMENT MC00007

Manage Inductions - Conduct New Employee Induction
All new employees are provided with adequate inductions

CHANGE(S) PENDING
SIGNOFF(S): Bev Jones
Helen Zahra
DUE DATE:
FREQUENCY: Fri every week

TREATMENT MC00049

100% of annual performance reviews undertaken

SIGNOFF(S): Bev Jones
DUE DATE: 31 Dec 2019
FREQUENCY: The last Day of every 12 months

TREATMENT MC00050

Manage Employee Termination - Receive notification
Ensuring that employee terminations are managed appropriately and equitably to minimise risk of further action

SIGNOFF(S): Bev Jones
DUE DATE: 01 Jan 2020
FREQUENCY: The first Day of every 3 months

TREATMENT MC00051

Manage Staff Training - Identify Training Needs
Ensure staff training needs are identified and met

CHANGE(S) PENDING
SIGNOFF(S): Bev Jones
DUE DATE: 31 Oct 2019
FREQUENCY: The last Day of every 12 months

TREATMENT MC00052

Managing Staff Misconduct and Discipline - Identify Misconduct or Breach of Discipline
Ensure any / all staff misconduct is managed effectively and consistently

SIGNOFF(S): Bev Jones
DUE DATE: 31 Jan 2020
FREQUENCY: The first Day of every 3 months



Audit Committee Meeting Minutes
9 October 2019



RESIDUAL
2.4
LOW

INHERENT
8.0

R00014

GENERAL, SERVICE INTERRUPTION

Business Interruption

A local physical event causing the inability to continue business activities and provide services to the community. This may or may not result in Business Continuity Plans to be invoked.

This does not include disruptions due to:

- IT Systems or infrastructure related failures should be captured under "Failure of IT Systems and Infrastructure".
- Contractor / Supplier issues should be captured under "Inadequate Supplier / Contract Management".
- People issues should be captured under "Inappropriate People Management".

OWNER Jason Whiteaker (Portfolio Manager)

CREATED 24/05/2019 06:43:56

LIKELIHOOD Unlikely

SEVERITY Major

CONTROL EFFECTIVENESS Strong

TREATMENT MC00022

Business Continuity Plan in place and up to date

SIGNOFF(S):

Aiyela McCall
Jason Whiteaker

DUE DATE:

30 Nov 2020

FREQUENCY:

The first Day of every 48 months

UNCONFIRMED

5.8 COMPLIANCE REPORT

Address:	N/A
Owner:	Shire of Northam
Applicant:	N/A
File Reference:	1.6.1.6
Reporting Officer:	Cheryl Greenough, Governance/Administration Coordinator
Responsible Officer:	Jason Whiteaker, Chief Executive Officer
Officer Declaration of Interest:	Nil
Voting Requirement:	Simple Majority
Press release to be issued:	No

BRIEF

This report is to provide Council with an overview of the Shire's monthly compliance activities.

ATTACHMENTS

- Attachment 1: August Compliance Calendar.
Attachment 2: Creditors Checklist.

A. BACKGROUND / DETAILS

Under the Local Government (Audit) Regulations 1996, a Local Government is required to carry out a Compliance Audit for the period 1 January to 31 December of each year. The Shire of Northam considered ways of ensuring this compliance was met on a monthly basis and to fulfil this role, commenced a monthly Compliance Calendar.

B. CONSIDERATIONS

B.1 Strategic Community / Corporate Business Plan

Theme Area 6: Governance & Leadership.

Outcome 6.3: The Shire of Northam council is a sustainable, responsive, innovative and transparent organisation.

Objective: Provide outstanding customer service.
Maintain a high standard of corporate governance.

B.2 Financial / Resource Implications

N/A.

B.3 Legislative Compliance

There is no legislative requirement to maintain a Compliance Calendar, however it is considered best practice and covers the following Regulations:

- Local Government (Functions and General) Regulations 1996;
- Local Government (Administration) Regulations 1996;
- Local Government (Elections) Regulations 1997;
- Local Government (Audit) Regulations 1996;
- Local Government (Rules of Conduct) Regulations 2007.

B.4 Policy Implications

Nil.

B.5 Stakeholder Engagement / Consultation

Nil.

B.6 Risk Implications

Risk Category	Description	Rating (consequence x likelihood)	Mitigation Action
Financial	Potential disruption to purchases	Moderate (6)	Ensure Calendar is followed
Health & Safety	Possible disruption to safety	Low (2)	Ensure any areas related to safety are followed
Reputation	The potential exists for legal ramifications	High (10)	Ensure legislation is followed
Service Interruption	If the calendar is not followed there is potential for certain services not to be provided on time.	Low (3)	Ensure Calendar is maintained
Compliance	The Legislative requirements of Council can be missed in error.	High (10)	A compliance Calendar provides the mechanism to ensure Legislation is adhered to
Property	N/A		
Environment	N/A		

C. OFFICER'S COMMENT

The monthly Compliance Calendar is an effective tool which will be used to assist in populating the Annual Compliance Audit Return (CAR) and will ensure

Audit Committee Meeting Minutes
9 October 2019



the Shire is able to identify and manage any issue which may arise during the year in a timely manner.

March 2019 –

- There was one instance under Delegated Authority where a crossover was not placed on the register as is required by legislation.
- The random Creditors checks revealed two transactions where invoices had not been provided in the paperwork.

April 2019 - there were 2 areas of non-compliance. One related to road closures where the Flying 50's had not yet been placed on the register. The other related to one checklist not being correctly filled out for a purchase order.

May 2019 - there were 4 areas of non-compliance with the Gift Register not up to date on the website due to a changeover of website. This has now been rectified and updated on the new website. The other three items relate to purchase orders not being written prior to the date of invoice.

June 2019 - For this month the compliance calendar was compliant, the only non-compliance related to 4 purchase orders which were written after the date on the invoice.

July 2019 - Again the calendar was 100% and the random Creditor checks were also 100% compliant.

August 2019 - Revealed the Financial Interest Register was not up to date on the website, however the hard copy was. During the random Creditor checks there were 2 checklists not completed correctly and 1 purchase order written after the date of invoice.

Below is a table providing the level of compliance for each month. It is apparent that the least compliance occurs with purchase orders and that may be because at times invoices are lost and reprinted or items are purchased quickly and the invoice is dated on the day the officer rang to order.

Month	Item	% compliance	Non Compliance
March	Crossover approvals	97%	Register not completed
	Random Creditor check	80%	2 items not compliant, no invoice attached

Audit Committee Meeting Minutes
9 October 2019

April	Temporary closure of roads	97%	flying 50's was not on register
	Random Creditor check	90%	1 item not compliant, P/O not attached
May	Gift Register	98%	Gift register not up to date on website
	Random Creditor check	70%	3 purchase orders written after the invoice date
June	Calendar	100%	
	Random Creditor checks	60%	4 purchase orders written after the invoice date
July	Calendar	100%	Compliant
	Random Creditor checks	100%	Compliant
August	Financial interest register	97.5%	Not up to date on website
	Random Creditor check	70%	3 not compliant – 2 checklist not completed correctly; 1 P/O written after invoice.

RECOMMENDATION / COMMITTEE DECISION

Minute No: AU.130

Moved: Cr Antonio

Seconded: Cr Mencshelyi

That Council receive the update as provided in the monthly Compliance Calendar Report.

CARRIED 2/0

Clarification was sought in relation to how we can improve with respect to the compliance items identified? The Executive Manager Corporate Services advised that matters are raised with individual staff as required and they are referred back to the process.

Audit Committee Meeting Minutes
9 October 2019



Attachment 1

SOURCE	Section	PROCESS OWNER	AUGUST COMPLIANCE CALENDAR		SCHEDULE	COMMENTS	Sign
			ACTIVITY DESCRIPTION	COMPLIANCE ACCOUNTABILITY			
Local Government Act 1995	53.59 - Commercial Enterprises	CEO	Have SOA entered into any major trading undertakings, if so has section 3.59 been complied with		Monthly	Not for the month of August	CB
Local Government Act 1995	55.16	CEO	Is the delegations register current (ie not more than 12 months old)		Annually - June	Current for the month of August	CB
Local Government Act 1995	55.67	CEO	Where an elected member disclosed a financial interest, did they leave the meeting and not participate in discussion or decision making on the item		Monthly	No financial interest disclosures were made	CB
Local Government Act 1995	55.65 & 55.73	CEO	Were all known elected member and staff disclosures of impartiality made at the Council meeting		Monthly	To the best of our knowledge	CB
Local Government Act 1995	55.73 & 5103	CEO	Were ALL disclosures recorded in the minutes		Monthly	Yes all impartialities declared were recorded in the Minutes	CB
Local Government Act 1995	55.75	CEO	Have primary returns been lodged within 3 months of elected member 'start		2x annually	N/A	CB
Local Government Act 1995	55.76	CEO	Have all new 'designated' employees completed their primary returns within 3		Monthly	No new designated employees	CB
Local Government Act 1995	55.76 & 55.77	CEO	Have all Elected Member Annual Returns been lodged and acknowledged in writing		Annually - August	Yes all have been provided as per the Act	CB
Local Government Act 1995	55.76 & 55.77	CEO	Have all Designated Staff Annual Returns been lodged and acknowledged in writing		Annually - August	Yes all have been acknowledged in accordance with the Act	CB
Local Government Act 1995	55.88	CEO	Is the register of financial interests up to date		Monthly	The hard copy is up to date but not up to date on the website	CB
Local Government Act 1995	55.89	CEO	Have all resigned members and staff returns been removed from the financial		Monthly	yes they have	CB
Local Government Act 1995	5103	CEO	Is the gift register up to date on an on the Council website		Monthly	There are no new entries for August	CB
Local Government Act 1995	53.58 - Disposal of Property	CEO	Did the Council dispose of any property in the month, and if so was 53.58 complied with		Monthly	Yes lots 470 and 471 Gt Eastern Highway in accordance with the Act. Advertised 14/8/19	CB
Local Government Act 1995	56.16	EMCS	Has a report to Council been done for a review of fees and charges		Annually	Yes, initially adopted in May the went up with the Budget 21 August 2019	CB
Local Government Act 1995	55.121	EMCS	Has the complaints officer maintained the complaints register and is the online register up to date		Monthly	No complaints for August	CB
Local Government Act 1995	53.57 & F/G Reg 11	EMCS	Have tenders been called for all goods or services in excess of \$150k		Monthly	No tenders for August 1x RFL for fire trucks	CB
Local Government Act 1995	53.57 & F/G Reg 14	EMCS	Was state wide public notice given for all tenders		Monthly	N/A	CB
Local Government Act 1995	F/G Reg 16	EMCS	Receiving and opening tenders completed by two persons, details of tenders to be immediately recorded		Monthly	No tenders were opened in August	CB
Local Government Act 1995	F/G Reg 18	EMCS	Rejecting and accepting tenders		Monthly	N/A	CB
Local Government Act 1995	F/G Reg 18 (1)	EMCS	Tender to be submitted before close of Tender and submitted to the Shire office		Monthly	N/A	CB
Local Government Act 1995	F/G Reg 18 (4)	EMCS	Written evaluation of each Tenderer's criteria		Monthly	N/A	CB
Local Government Act 1995	F/G Reg 17	EMCS	Tender Register to be maintained and available for inspection		Monthly	Done	CB
Local Government Act 1995	F/G Reg 19	EMCS	Tenderers to be notified of outcome		Monthly	N/A	CB
Local Government Act 1995	F/G Reg 24A4 (2)	EMCS	Statewide Public Notice of the invitation to apply to join a pre-qualified panel		Monthly	N/A	CB
Local Government Act 1995	F/G Reg 24A4 (4)	EMCS	Notice to include brief description of goods and services to be supplied by pre-qualified panel		Monthly	N/A	CB
Local Government Act 1995	LG (Elections) Regulations 1997	Governance	Declare if the election is to be postal		Bi-annually	Completed by 31/7/19	CB
Local Government Act 1995	LG (Elections) Regulations 1997	Governance	Give Local Public notice of close of enrolments		Bi-annually	Completed 30/8/19	CB
Local Government Act 1995	LG (Elections) Regulations 1997	Governance	Prepare Owner Occupier Roll		Bi-annually	Completed by 20/8/19	CB
Local Government Act 1995	LG (Elections) Regulations 1997	Governance	Roll closes 30/8/19		Bi-annually	Closed Roll 30/8/19	CB
	Delegation - B02	EMDS	Buildings - Grant or Refuse Demolition Permit - register completed?		Monthly	N/A	
	Delegation - E01	EMDS	Temporary Closure of Thoroughfares to vehicles		Monthly	Road Closure for the Avon Descent was advertised in 31 July edition of the Avon Valley Advocate. Gordon Place road closures were advertised 7/8/19 in Advocate	CB
	Delegation - E04	EMDS	Crossover Approvals		Monthly		
	Delegation - F02	EMCS	Disposal of Council property		Monthly	Lot 470 and 471 Great Eastern Highway	CB

Audit Committee Meeting Minutes
9 October 2019



	Delegation - FOS	EMCS	Inviting Tenders	Monthly	N/A	
		EMCS	Interim Audit	Annually	Completed April this year	
		EMCS	Accounts presented to Council	Monthly	June Accounts were presented at the 10 July 19 meeting	
		EMCS	Financial Report to Council	Monthly	June report was presented at the 10 July 19 meeting	
Reporting	Building Services (Complaint Resolution and Administration) Regulations 2011	Building	Building Services Levy - Payment due by 14th day after the end of the month	Monthly	Yes and given for payment	
Reporting	Building and Construction Industry Training Fund and Levy Collection Regulations 1991	Building	Building Construction Training Fund Levy - Payment due by 10th day after the end of the month	Monthly	Yes and given for payment	

UNCONFIRMED

Attachement 2 August Creditors

EFT #	Creditor	Order #	Invoice Amount	Order Amount	Purchase Order Written	Signing Officer Name	Supporting Invoice Attached	Purchasing Procedure Checklist attached and completed correctly	Date of order prior to date of invoice
34031	Applied Industrial Technologies	54979	152	150	19/07/2019	Parks & Gardens	yes	yes	same
34037	Avon Valley Contractors	55316	330	413	16/08/2019	works manager	yes	yes	yes
34151	Ampac Debt Recovery	Payment Request	19,930	19,930	31/08/2019	EMCS	yes		
34160	Avon Demolition & Earthmoving	54968	1,568	26,268	18/07/2019	EMDS	yes	yes	yes
34169	CDA Air & Solar	55216	925	990	7/08/2019	Building Manager	yes	yes	yes
34178	Executive Media	55311	1,995	1,995	15/08/2019	Tourism	yes	No	No
34184	IW Projects	541881	7,499	8,602	10/07/2019	EMDS	yes	yes	yes
33919	Access Protocol	54994	792	792	22/07/2019	Killara manager	yes	No	yes
33932	Avon Paper Shred	54817	65	60	3/07/2019	EMCS	yes	No	yes
33946	Commercial Systems Australia	54439	10414.8	10414.8	29/05/2019	EMES	yes	yes	yes

Audit Committee Meeting Minutes
9 October 2019



5.9 PARKS AND GARDENS AUDIT

Address:	N/A
Owner:	Shire of Northam
Applicant:	N/A
File Reference:	1.3.6.9
Reporting Officer:	Cheryl Greenough, Coordinator Governance / Administration
Responsible Officer:	Clinton Kleynhans, Executive Manager Engineering Services
Officer Declaration of Interest:	Nil
Voting Requirement:	Simple Majority
Press release to be issued:	No

BRIEF

For Council to receive the report from XYST who conducted the Open Space Review and Business Improvement Plan (Parks and Gardens Audit) for the Shire of Northam.

ATTACHMENTS

Attachment 1: Northam Parks and Gardens Service Review.

A. BACKGROUND / DETAILS

Under the direction of the CEO, staff called for quotes from suitably qualified consultants to conduct an audit of our service provision in the parks and gardens area.

In November 2018 the Executive Manager Engineering Services and the Governance Officer met with Mr Brian Milne from XYST Australia P/L to discuss an audit of the Shire's playgrounds and parks and current service levels. The Audit was designed to provide both Senior Staff and Council with an additional element of reassurance by means of a performance review versus the expenditure.

XYST were engaged to perform the following scope of works:

- Review existing documentation relating to parks asset management, open space planning and service delivery;
- Undertake individual office and site-based meetings with each of the Parks and Gardens management team to identify strengths and weakness and opportunities for improvement (Day 1);

Audit Committee Meeting Minutes
9 October 2019



- Run a full day workshop with Parks and Gardens Management and team to identify a comprehensive business improvement program (Day 2)
- Identify training with discussion to develop initial framework for operational levels of service in focus areas;
- Identify possible solutions, priorities and required resources;
- Document a recommended improvement program and action plan;

B. CONSIDERATIONS

B.1 Strategic Community / Corporate Business Plan

Theme Area 2: Community Wellbeing

Outcome 2.2: There are a variety of recreation and leisure activities available for all ages, across the Shire of Northam.

Objectives:

- Maintain a range of sporting facilities in Northam, as expected of a Regional Centre;
- Maintain local facilities in other local communities in the Shire of Northam;
- Facilitate the provision of varied cultural and artistic activities;
- Provide a range of quality activities for specific demographics, including seniors and youth;
- A range of outdoor leisure activities available throughout the Shire;
- To have well maintained reserves within the Shire of Northam.

B.2 Financial / Resource Implications

Nil.

B.3 Legislative Compliance

Local Government Act 1995 and relevant subsidiary legislation.

B.4 Policy Implications

N/A

B.5 Stakeholder Engagement / Consultation

XYST Australia who conducted the Audit

B.6 Risk Implications

Risk Category	Description	Rating (consequence x likelihood)	Mitigation Action
Financial	Under \$20,000	Low (2)	Asset management planning
Health & Safety	Potential medical injuries	Medium (3)	Put non slip surfaces in place, regular maintenance

Audit Committee Meeting Minutes
9 October 2019



Reputation	Low impact, low news items	Minor (2)	
Service Interruption	N/A	N/A	N/A
Compliance	No noticeable regulatory compliance issues	Insignificant (1)	Quality Control
Property	N/A	N/A	N/A
Environment	N/A	N/A	N/A

C. OFFICER'S COMMENT

A performance quality assessment was undertaken of operations and maintenance standards across 15 parks. A typical performance target is 85% and Northam is performing above this level at 90%.

There are some areas of improvement required such as garden maintenance and some general maintenance. At 70% we provide a higher number of playgrounds but less youth facilities than some other councils who would be considered our peers.

The Shire's total expenditure budget per capita is consistent with our peer groups at \$132,905. The Best Practice scores indicate room for improvement in some areas whilst other areas are equal to or better than average.

The audit findings will be used to develop further the pending Parks and Gardens Asset Management Plan and associated service levels. This will be presented to Council for adoption at a later date.

RECOMMENDATION / COMMITTEE DECISION

Minute No: AU.131

Moved: Cr Antonio

Seconded: Cr Mencshelyi

That Council receive the Open Space Review and Business Improvement audit report as presented.

CARRIED 2/0

The Coordinator Governance / Administration left the meeting at 4:34pm and returned at 4:36pm.

The Acting Chief Executive Officer advised that there were no surprises in the audit report. It was outlined that the garden maintenance is not where should be. Officers sought clarification on how this was determined and it was advised

Audit Committee Meeting Minutes
9 October 2019



that they randomly selected parks. Some of those which were selected were programmed/scheduled in the following days of the audit. Another item also raised was recording the square metres of garden which Council does not currently measure.

Attachment 1



Shire of Northam Parks and Gardens Service Review



FINAL: AUGUST 2019

Table of Contents

Executive summary	2
1.0 Introduction	3
2.0 Current performance	4
2.1 Operation and maintenance.....	4
2.2 Asset provision.....	5
2.2.1 Introduction.....	5
2.2.2 Total park land.....	5
2.2.3 Actively maintained and natural areas.....	6
2.2.4 Grass sports fields.....	6
2.2.5 Grass mowing area (parks and verges).....	7
2.2.6 Playgrounds and Youth Facilities.....	7
2.2.7 Park furniture.....	8
2.2.8 Public toilets.....	8
2.2.9 Unreported.....	9
2.3 Financial performance - operations and maintenance.....	9
2.3.1 Total operation and maintenance cost.....	9
2.3.2 Actively maintained park operation and maintenance cost.....	9
2.3.3 Sports parks.....	10
2.3.4 Trees.....	10
2.3.5 Youth facilities.....	11
2.3.6 Public Toilets.....	11
2.3.7 Unreported.....	12
2.4 Management.....	12
2.4.1 Financial comparison.....	12
2.4.2 Best practice comparison.....	13
3.0 Structure and resources	14
3.1 Structure.....	14
3.3.1 Operations Resourcing and Approach.....	14
3.3.2 Options for improvement.....	15
3.4 Other issues.....	16
3.3.1 Tools and equipment.....	16
3.3.2 Succession planning.....	16
APPENDICES	17
Appendix One - Yardstick individual summary report.....	18
Appendix Two - Maintenance quality performance questionnaire report example.....	23



Executive summary

A service review of the City of Northam Parks and Gardens section was undertaken by Xyst Australia from May to June 2019.

This review identified the following key points:

- Current maintenance standards being achieved are reasonably good, other than garden maintenance in Northam
 - Provision of actively maintained open space is relatively low compared to average industry provision
 - Operation and maintenance costs are relatively high, both for per hectare (efficiency) and per resident (level of service) metrics. A low level of park land and small population will typically contribute to these costs being comparatively higher
 - A relatively high number of playgrounds and youth facilities are provided
 - Provision of park furniture per hectare is largely consistent with, but slightly higher than industry comparison for all furniture types
 - A major challenge is the difficulty of recruiting staff with suitable skills and aptitude
 - There is scope for improving the organisation of work practices and improving team management, and culture.
- **Key Recommendations**
- Identify area of natural open space land, to achieve more complete/accurate picture of total open space provision
 - Review level of playground provision to assess whether rationalisation is desirable (consider preparation of a playground strategy)
 - Implement a staff trainee/apprentice and development program
 - Engage management/ support to assist with implementing the staff trainee and development program and provide management mentoring.
 - Reorganise some aspects of the service delivery approach to move from a focus on cyclic park maintenance to a more prioritised approach with completion of key tasks and targeted combining of staff resources.

1.0 Introduction

Xyst were commissioned to undertake a service review of the Parks and Gardens section in May 2019.

The methodology included:

- Participation in the IPWEA Yardstick benchmarking program
- Performance assessment of quality of maintenance and operation standards on a range of parks across the municipality
- Review of existing documents relating the management and planning for parks
- Workshop meetings and individual interviews with parks and gardens staff
- Preparation of operating service standards
- Preparation of development service standards
- Preparation of summary report

2.0 Current performance

2.1 Operation and maintenance

A performance quality assessment was undertaken of operations and maintenance standards across 15 parks, in May 2019. These were selected to provide a sample of different parks categories together with a geographic spread across the shire.

The overall result was an average score of 90%.

A typical performance target is 85%, therefore overall, Northam is performing above this level. However, nearly half of the parks were below the 85% target, which indicates some room for improvement.

The main area for improvement relates to garden maintenance, plus some general maintenance issues. Grass maintenance was consistently meeting a high standard at all sites visited.

Assessing performance based on one sample provides a snapshot view only, plus maintenance standards are somewhat easier to achieve during the low growth drier autumn months compared to spring periods. To achieve a more comprehensive analysis of performance would require the multiple assessment of the parks over a full year period.

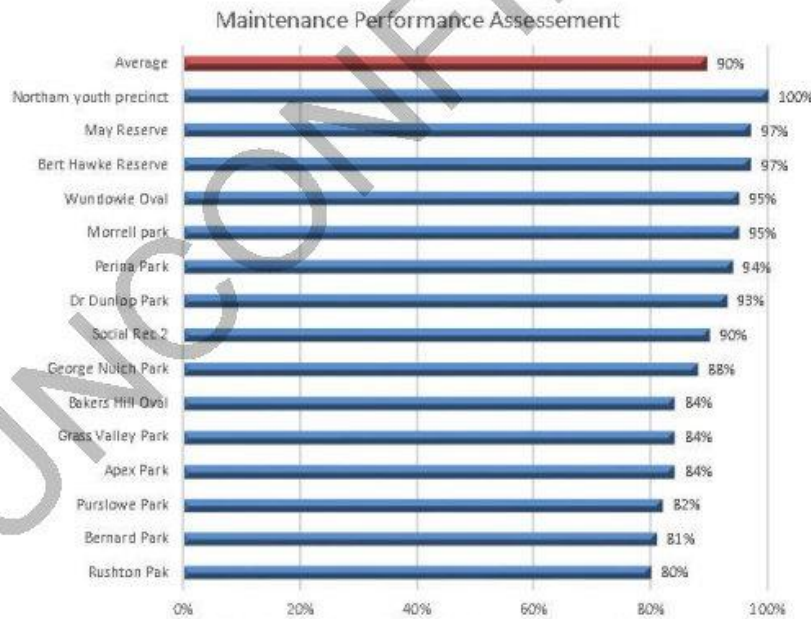

Figure 1.1 Maintenance standards performance assessment results

Audit Committee Meeting Minutes
9 October 2019



The methodology involved assessing each park, across a range of common park maintenance activities, compared with typical industry best practice for the park category/service standard. Each task/outcome was scored on a 5-step scale from very good to very poor. An overall percentage score is then calculated based on the total possible score for each park. Refer to Appendix One for an example of an individual park report and the items assessed.

Note: Performance assessment is normally undertaken against set operation and maintenance service specifications and performance targets. As Northam did not have in place detailed service specifications or performance targets, scoring was based on typical industry best practice approach (which generally, does not vary significantly from place to place).

2.2 Asset provision

2.2.1 Introduction

As part of the service review, Northam participated in the IPWEA Yardstick Benchmark program. This program annually collects a range of information from participating organisations relating to parks land and asset provision, financial information and management practices to produce a wide range of performance metrics to assess relative levels of service performance and efficiency.

A sample of relevant results are provided below to provide an indication of Northam's current level of service in relation to the industry. The peer group is a selection of 5 other councils that are similar in population size and/or locality. The organisations selected for Northam's peer group are listed in table 2.1 below.

Organisation	Population
Shire of Northam (WA)	11,230
Town of Port Hedland (WA)	14,469
Port Pirie Regional Council (SA)	17,718
Whyalla City Council (SA)	21,828
City of Karratha (WA)	22,195
Richmond Valley Council (NSW)	23,317
Singleton Council (NSW)	23,482

Table 2.1 Yardstick Peer Group

2.2.2 Total park land

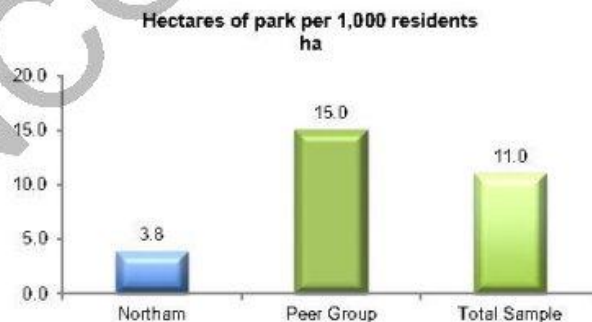

The provision of parkland includes both actively maintained and natural parks. Overall provision is significantly lower than both the peer group and total sample, indicating a relatively low level of park provision overall. (However, no Natural park land has been included in Northam's response, see 2.2.3)

2.2.3 Actively maintained and natural areas

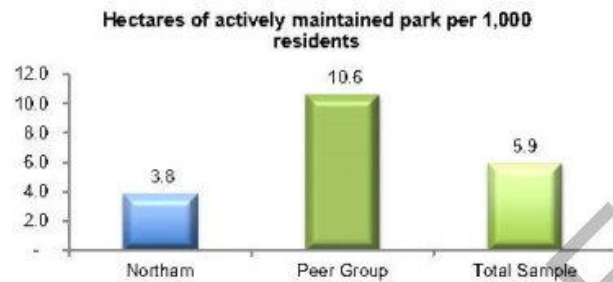

Maintained parkland per 1,000 residents is lower than both the peer and total sample median.

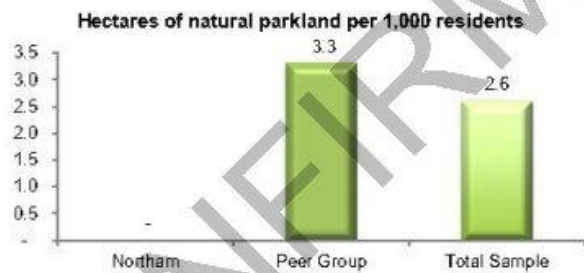

No Natural parkland area was identified in the Northam response. While there is minimal maintenance activity undertaken on natural areas, it is likely that Northam does have some natural open space land that has not been accurately identified and therefore not included in the Yardstick. This also contributes to the low level of park provision in comparison to industry results.

2.2.4 Grass sports fields

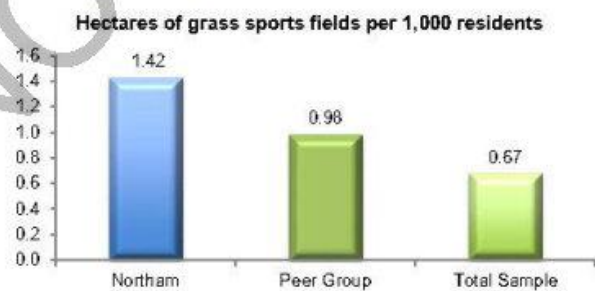

Provision of sports parks is higher than both the peer group and total sample medians.

2.2.5 Grass mowing area (parks and verges)

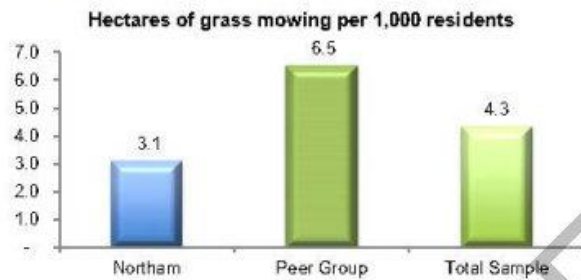

Grass mowing area is somewhat lower than both the peer group and total sample medians.

2.2.6 Playgrounds and Youth Facilities

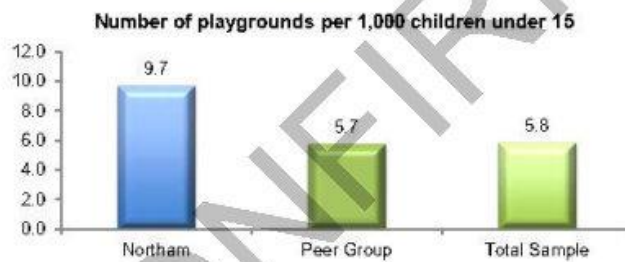

Provision of playgrounds is 70% higher than both the peer group and total sample (and is the highest in Australia).

Provision of youth facilities is slightly lower but consistent with both the peer group and total sample.

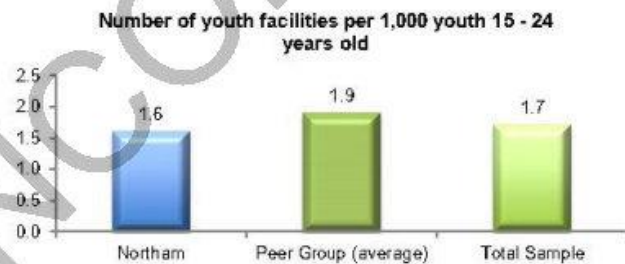

2.2.7 Park furniture

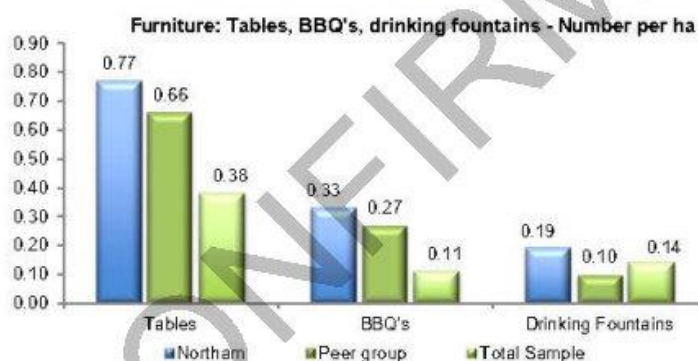
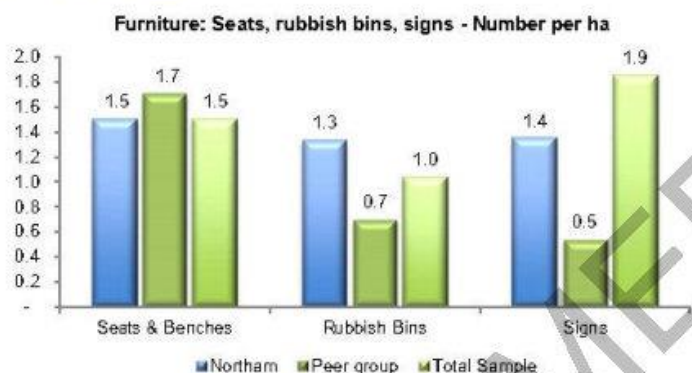

Provision of park furniture is largely consistent with, but slightly higher than industry comparison for all furniture types

2.2.8 Public toilets

Number of public toilets per 1,000 residents

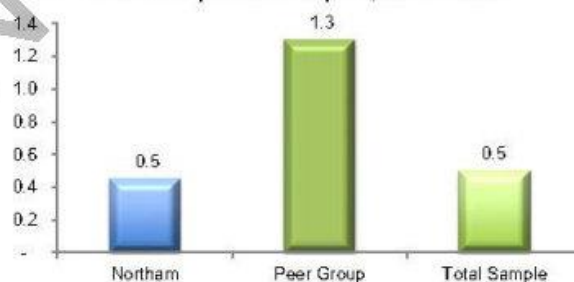

Provision of public toilets is consistent with the total sample but lower than the peer group

2.2.9 Unreported

The following activities were not able to be assessed due to lack of asset quantity data:

- Total sports parks area
- Trails and paths
- Street trees
- Gardens

2.3 Financial performance – operations and maintenance

2.3.1 Total operation and maintenance cost



Total expenditure budget per capita is consistent with the peer group but above the total sample by 14%.

2.3.2 Actively maintained park operation and maintenance cost

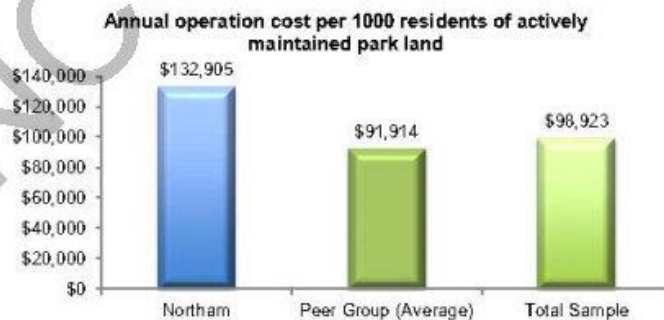

Expenditure budget per capita for actively maintained park land is higher than both the peer group (by 45%) and the total sample (by 34%).

2.3.3 Sports parks

Grass sportsfields maintenance expenditure per 1,000 residents

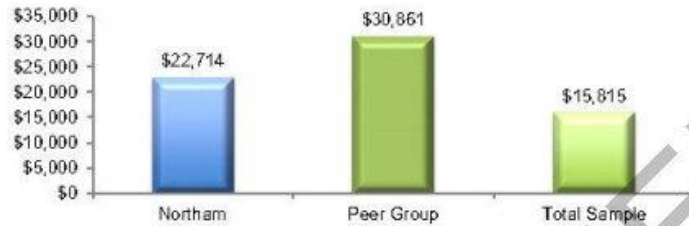

Expenditure for grass sport fields per capita is sitting approximately midway between the peer group and total sample.

Grass sportsfields maintenance expenditure budget per ha

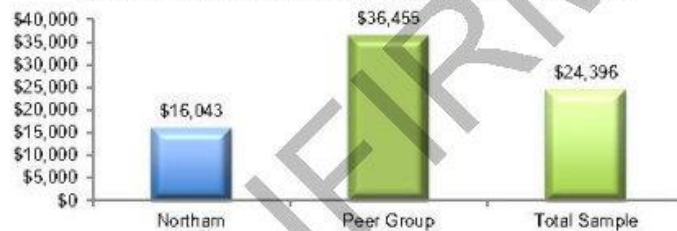

Expenditure on grass sportsfields maintenance per hectare is lower than both the peer group and the total sample (average of 45%).

Note: the peer group results are highly variable, ranging from 3 very high to 2 very low results.

2.3.4 Trees

Street tree maintenance expenditure budget per 1000 residents

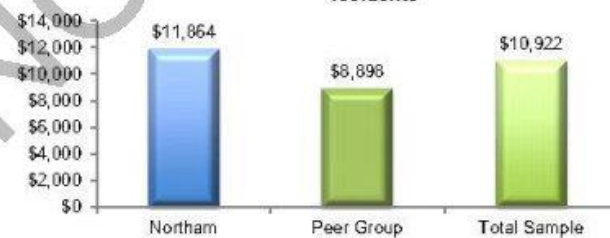

Street tree maintenance expenditure per capita is higher than both the peer group and total sample by an average of 21%.

2.3.5 Youth facilities



Youth facility expenditure is somewhat higher than the total sample both on per capita and per facility analysis, however this should be seen as a positive, reflecting of good level of service.

Note: Peer group analysis not provided due to lack of sufficient data

2.3.6 Public Toilets

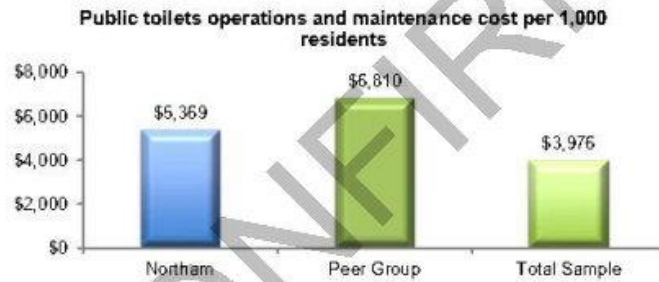

Expenditure on public toilets on a per capita comparison is 21% lower than the peer group but 35% above the total sample.

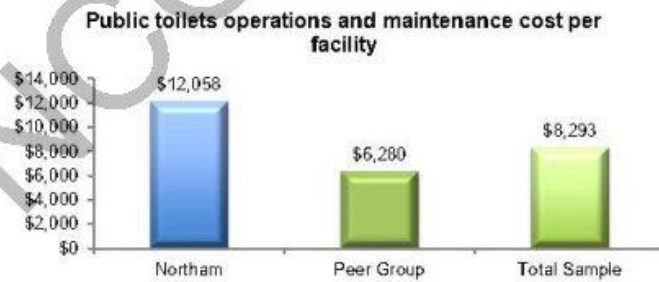

Expenditure per facility is significantly above the peer group (92%) and the total sample (45%).

2.3.7 Unreported

The cost for the following activities were not able to be calculated due to lack of financial data being separately captured at the activity level:

- Grass mowing
- Gardens
- Playgrounds
- Paths and trails
- Refuse and Graffiti

The first three items are significant activities where the identification of operation and maintenance cost is highly desirable to assess relative levels of service and efficiency.

2.4 Management

2.4.1 Financial comparison



Expenditure on staff management (office-based management and supervisory staff) is consistent with the peer group but 38% higher than the total sample.

However, the cost per hectare comparison is relatively high at \$4,445 per hectare which is an average of 119% above the peer group and total sample.



2.4.2 Best practice comparison

The Yardstick Best Practice scores identify management performance based on a selected range of management tasks that are considered "key" to the management and delivery of parks services.

The best practice scores provide an indicator of opportunities for improvement in operational and management performance. They can be used in the preparation of a parks management improvement plan, and to track your progress over time.

They are scored as part of the Yardstick process by experienced and independent auditors based on the responses provided to a range of management questions.

A copy of the individual results are included in Appendix 1.



An overall best practice score of 42% indicates there is significant room for improvement in management practices.

At an individual category level, the major weakness is in the strategic planning and community engagement area, with operational management practices also relatively weak. The strongest area is in asset management.

3.0 Structure and resources

3.1 Structure

The existing staff structure is relatively simple with the Parks, Gardens and Reserves Operations Manager and three leading hands being responsible for day to day operations and maintenance and service planning.

This is supported by the Executive Manager, Engineering Services providing overall management responsibility.

This structure appears adequate and effective for the scale of Northam's operation.

There is some overlap in the management of services, with the separate Recreation Services Department being responsible for sports parks booking, which while not ideal, compared to a fully aligned service approach, is relatively typical for most council management structures.

3.3.2 Operations Resourcing and Approach

At an operational level, there are a total of 14 staff, organised as follows:

- Wundowie- 2 staff
- Parks and POS – 4 staff
- Verges and Gardens – 8 staff

A detailed staff sizing analysis has not been undertaken, however there were no reported issues of lack of staff resources and the number of staff appears appropriate for the scale of operation.

The major reported issue with staffing, is the quality and retention of staff. Due to Northam's small population size and relative isolation from other residential centers', the ability to attract and retain technically skilled, good quality staff is limited. This also potentially results in the need to retain some staff who are underperforming, due to the difficulty of replacing the staff.

There is some imbalance with size of each of the teams and also the work and responsibilities may not be organised in the way that the staff structure indicates. For example the parks and POS leading hand operates largely independently, with the staff in this section likely directly supervised by the Operations Manager.

There is some disharmony and frustration amongst the parks and gardens management team and the organisation and management of personalities and staff resources may be contributing to this. There is a level of resentment apparent, that may be a consequence of the imbalance of work load and resources and a fairly divided (isolated) approach to the organisation of the work.

For example the Wundowie team operates independently and physically isolated from the rest of the staff in Northam. Even though the team is small it appears to cope comfortably with its workload, and consequently is possibly over servicing some areas/activities. By comparison the Verges and Gardens team seem to be struggling to meet demand (a view supported by the poor garden maintenance scores in the performance assessment, primarily in the Northam area).

The approach to work programing (in the Verges and Gardens team particularly) appears to be based on moving through the sites on relatively fixed schedule, with a set amount of time allocated to each site, with an approach of getting done what can be done in the time available, this inevitably results in some tasks e.g. garden weeding only being partially completed at any site, and lower priority or less desirable tasks rarely being attended to. This is also a result of the crews having multiple task responsibilities such as general site tidying/cleaning as well as garden maintenance. This approach isn't inherently wrong, but to work, an adequate amount of time/resource must be allocated to fully finish all the required tasks on a site.

From the level of service workshops, there was also a view that many sites needed a high frequency of visits/servicing, which as well as being unnecessary from a LoS point of view, was evidently not being achieved, was leading to greater level of stress and feeding a sense of continually rushing around (trying very hard) but ultimately doing nothing really well.

There was an attempt in the past to combine staff resources better, by requiring the Wundowie staff to operate out of the Northam depot. This apparently did not work particularly effectively, resulting in a return to the status quo.



Figure 3.1 Parks and Gardens staff structure

3.3.3 Options for improvement

Staff development

Due to the limited ability to attract quality staff with appropriate skills from the local population, an alternative may be to embark on an internal staff development program. This would involve taking on 1-2 new trainees every year, targeting school leavers, or other suitable people with potential. The trainee will be supported/developed with a strong personal development program via online training programs and on the job training, undertaking a variety of roles.

While taking on 1-2 trainees every year may seem like a significant investment, there is a need to factor in the natural staff turnover where the trainees may leave for a variety of reasons. It is also an unfortunate outcome of this approach, that you are likely to lose some quality staff once trained, to other organisations.

This approach will also support community and economic development objectives of the Shire.

To ensure the success and commitment to this approach it may be desirable to engage ongoing external management mentoring to assist and support management staff in the delivery of this program.

Management staff development

To assist in improving communication, organisation and staff development skills, it is recommended that additional personal development be undertaken for the parks and gardens management team.

Additional and ongoing management mentoring, (possibly combined with the support for staff trainee development program) is also likely to be beneficial to assist in addressing this skills gap.

Audit Committee Meeting Minutes
9 October 2019



Change organisational approach

There are two suggestions for improving the organisational approach to the operations and maintenance work

1. Move away from the time limited, rotational scheduling of work, to focus on activities and completing that activity fully at each park.

For example, for cleaning/tidying activities, aim to complete these on a regular cyclic basis for L1 parks, but do not extend this visit into attempting to undertake other activities. For major tasks such as gardening, undertake this as a dedicated task, and fully complete each park before moving to the next. This may result in slightly less visits (for gardening work) to each park but will result in the service standard being fully achieved for that site.

2. Combine resources to complete major tasks. When undertaking major tasks e.g. garden cleanup at Bernard Park, mulching etc., combine all the staff with necessary skills to this site/task, and continue until the work required is completed. This should include staff from Wundowie and be programed for times of the year where labour and other resources are available.

It would be desirable for the Wundowie crew to work more closely with the Northam crews to create a better sense of teamwork and shared responsibility. However, rather than a permanent relocation or change of structure, a more targeted approach to combine resources for specific tasks is likely to be more effective. This would result in the Wundowie crew potentially spending a few days each month working at Northam sites. This approach should also be reciprocal, with Northam staff assisting at some Wundowie sites from time to time.

3. Make effective use of the operating levels of service. One of the objectives of developing the operating levels of service is to better understand the priority of service levels between parks and all the various tasks being undertaken – and the desired objective/outcome for each of the tasks. This will lead to more effective prioritization of sites and tasks and move away from the sense of trying to do "everything, everywhere, all the time".

3.4 Other issues

3.3.1 Tools and equipment

An issue raised by several members of the management team, was problems with management and care of tools and equipment at the Northam depot. Suggestions included dedicated locked tool cages and /or the use of a store person to manage tool and equipment allocation and undertake minor maintenance to ensure equipment is provided in good working order.

3.3.2 Succession planning

For any organisation it is desirable to have a staff succession so that when management staff leave (or are absent for normal leave periods) there are staff in place to step in, to ensure transition is as seamless as possible, and most importantly that staff knowledge is passed on and retained within the organisation. This is a particular challenge for small organisations; however, it appears to be a significant past and current issue at Northam. An improved staff development and mentoring program should assist in addressing this issue.

APPENDICES

UNCONFIRMED

Appendix One – Yardstick individual summary report

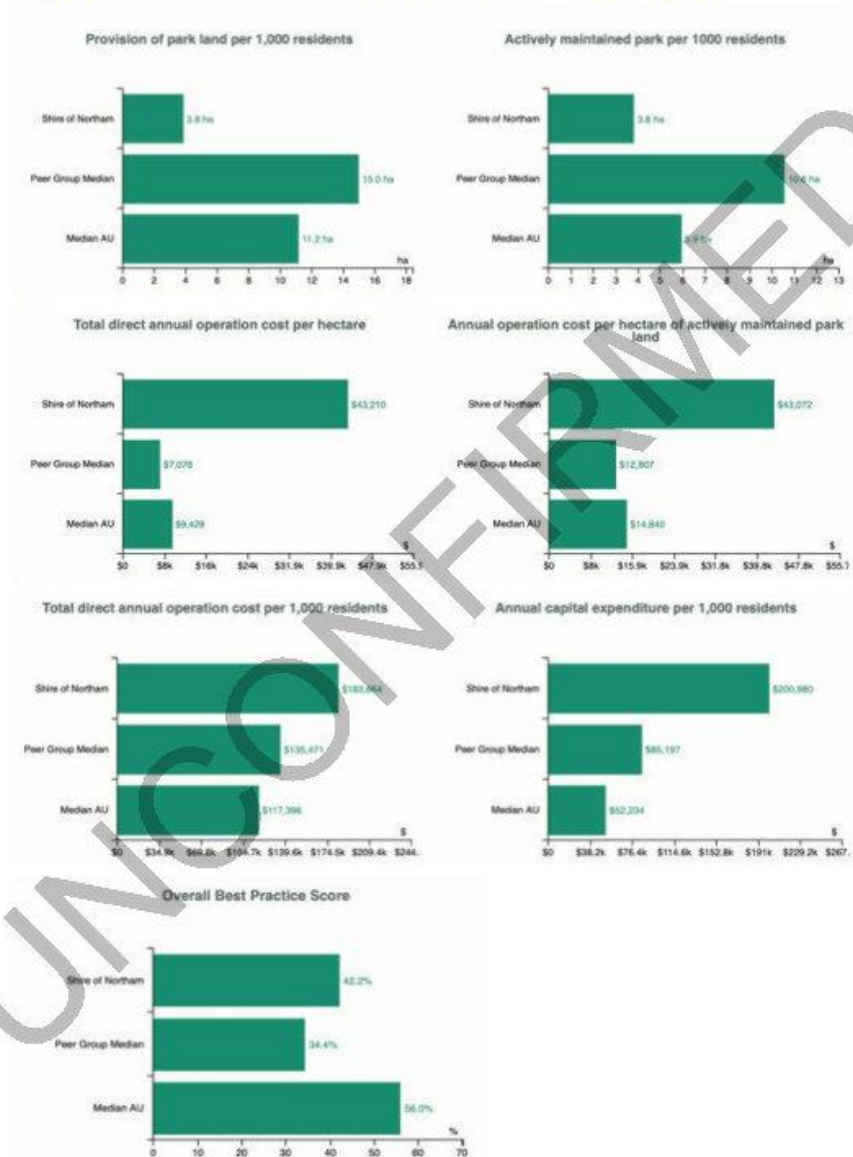

Shire of Northam - Parks and Gardens Service Review
August 2019

Best Practice Standards ✔ Meets best practice ● Improving ✘ Not achieved — Not applicable

Search: _____

Achieved	Score	Standard
Operational Excellence		36.11%
●	1.0	Market Testing of Parks Services Systems in place for reporting costs for all activities, and use of a mixture of outsourcing and benchmarking to market test internal service delivery operation.
●	1.5	Documented Service Standards Documented service standards in place for all parks maintenance activities to a detailed level, using a mix of prescriptive and performance terminology to describe the required inputs and outputs.
●	1.0	Service Delivery Quality Control – Sports Fields A formal system for monitoring and documenting the standard of service delivered and maintenance of sports fields, for both outsourced and internal service delivery. Should be based on documented service standards, use a weighted scoring system, and be undertaken in a repeatable, regular and systematic way.
✘	0.0	Service Delivery Quality Control Method – Planted Beds A formal system for monitoring and documenting the standard of service delivered and maintenance of garden beds, for both outsourced and internal service delivery. Should be based on documented service standards, use a weighted scoring system, and be undertaken in a repeatable, regular and systematic way.
✔	3.0	Service Delivery Quality Control Method – Toilets A formal system for monitoring and documenting the standard of service delivered and maintenance of toilets, for both outsourced and internal service delivery. Should be based on documented service standards, use a weighted scoring system, and be undertaken in a repeatable, regular and systematic way.
✔	2.0	Street Tree Maintenance Programming A planned, regular and systematic approach to cyclical street tree maintenance, usually over a 5-10 year period. Trees are classified into categories, usually based on a street tree inventory and assessment of location/risk. High profile/risk trees are maintained more regularly than low profile/risk trees.
✘	0.0	Service Delivery Quality Control – Grass maintenance A formal system for monitoring and documenting the standard of service delivered and maintenance of grass, for both outsourced and internal service delivery. Should be based on documented service standards, be compliant with national/national standards, use a weighted scoring system, and be undertaken in a repeatable, regular and systematic way.
✘	0.0	Ability to cost level of service Costs for maintenance and service delivery are recorded and reported at a level of detail that matches the asset hierarchy and key operational activities, so that operational costs can be accurately and reliably identified at the activity level. This information can then be used to cost current levels of service, as well as modeling changing levels of service costs.

Infrastructure Management		82.29%
●	2.0 Infrastructure Asset Management Plan	Documented plan completed to the International Infrastructure Management Manual standard, including a 10+ year long term financial plan, and updated regularly (at least 3 yearly). Basic components will include an inventory summary, asset condition information, levels of service, up to date valuation figures, an asset renewal plan, and an improvement plan.
●	2.5 Asset Inventory Completion	Documented condition information collection and maintenance methodology. Complete collection of parks asset condition data to component level, including estimates of remaining useful life. Information will be updated regularly (at least 3 yearly).
✓	3.0 Asset Condition Information	Documented data collection and maintenance methodology. Complete collection of parks asset condition data to component level, including estimates of remaining useful life. Information will be updated regularly (at least 3 yearly).
✓	3.0 Asset Valuation	Documented asset useful lives and replacement values, and undertake a valuation of all parks assets to component level. Information will be updated regularly (annually for growth areas and at least 3 yearly for other areas).
✓	3.0 Asset Renewal Plan in Place	Use asset condition information and replacement values to determine a 10-year capital renewal program for most parks assets.
●	1.0 Development Levels of Service	Documented statements for each park category which define the level of provision and quality of different assets provided. This should be at sufficient detail to assist with documenting development guidelines for developers, for arriving at a standard cost per hectare for development and maintenance of park land (for each park category), and for determining asset renewal, new asset development, or asset decommissioning programmes.
✓	3.0 Use of Full Life Cycle Costing	At the time of project approval all costs associated with a project are reported, including establishment, construction/installation, annual maintenance, whole of life maintenance, renewal and decommissioning costs. Approval of increased ongoing maintenance budget is linked to approval of capital project budget.

Strategic Planning		17.54%
✘	0.0	<p>Parks Strategy</p> <p>Categorised parks network, establish provision and development levels of service for each park category, assess current and future provision requirements, and document in a 10 year strategic plan for parks, including a disposal/acquisition implementation plan.</p>
✘	0.0	<p>Use of Provision Levels of Service Measure</p> <p>An overall park land provision target will be identified for parks, as well as individual park land provision targets for each park category. This may be further broken down into catchment areas. Targets will be expressed as area per capita, and will be referenced to reliable statistical information such as provided by Yardstick.</p>
✘	0.0	<p>Use of Distribution Levels of Service Measure</p> <p>Each park category will have measures relating to distribution, based on lineal or walking distance from residential properties, or similar. Quality statements will further define distribution, such as references required to geography, location, and site characteristics.</p>
✘	0.0	<p>Playground Strategy</p> <p>Categorise playgrounds and identify suitable catchments, establish provision and development levels of service for each playground category, assess current and future provision requirements, and document in a 10-year strategic plan for all playgrounds, including a costed, prioritised capital implementation plan.</p>
✘	0.0	<p>Public Toilet Strategy</p> <p>Categorise toilets and identify suitable catchments, establish provision and development levels of service for each toilet category, assess current and future provision requirements, and document in a 10 year strategic plan for all toilets, including a costed, prioritised capital implementation plan.</p>
✘	0.0	<p>Cemetery Strategy</p> <p>Categorise cemetery networks and identify suitable catchments, establish provision and development levels of service for each cemetery category, assess current and future provision requirements taking into account birth, migration and mortality statistics, and the presence of any crematoria. Document in a 10-year+ strategic plan for all cemeteries. Include operating policies and procedures, and criteria for future cemetery land assessment.</p>
✘	0.0	<p>Recreation Strategy</p> <p>Identify all recreation user groups, recreation and demographic trends, and establish a recreation classification based on user experience/motivation. Undertake comprehensive customer/user research to identify needs. Assess current provision of facilities and services against recreation/demographic trends, and results of customer research. Document in a 10-year strategic plan for all activities, including a costed, prioritised capital implementation plan.</p>
✔	2.5	<p>Street Tree Strategy</p> <p>Identify and document catchment areas and street tree categories based on location and/or risk, and establish provision, development and operating levels of service for each catchment/category, including suitable species. Document policies and procedures to manage tree requests, complaints, and removal requests.</p>
✔	2.5	<p>Trails/Walkway Strategy</p> <p>Identify trails and assess attributes, classify against walking and cycling standards and suitability for user groups. Established use monitoring plan. Identify gaps in provision and opportunities to improve connections (linked to parks strategy). Maintenance and structural inspections aligned to visitor group and usage. Costed 10 year development plan.</p>
—		<p>Natural Areas Strategy</p> <p>Identify natural areas and classify into different use or other category. Implement attribute/health assessment system. Establish biodiversity monitoring and management objectives and strategies. Identify threats and challenges. Establish pest and risk management strategies. Costed 10 year Improvement Plan.</p>

Environmental Sustainability		58.33%
✓	3.0	Implementation of biodiversity actions A range of biodiversity actions are being implemented including: Endangered or threatened species identified and monitored; Measures/actions in place to protect environments of endangered/threatened species; Planting of green spaces using locally eco-sourced plants to restore or enhance biodiversity values; Public education programmes to improve knowledge on the value of protecting/enhancing biodiversity.
●	2.0	Water Management Plan Review water asset inventory, assess current water use and requirements, identify water targets and water conservation measures, document and monitor in water management plan.
✗	0.0	Chemical usage management A policy or documented operations procedures to limit, reduce or mitigate any potential public health and environmental harm from the use of pesticides, herbicides and fertilisers.
Social Outcomes		16.67%
✗	0.0	Use of Park User Surveys Undertake intercept surveys of actual park users on at least a 2 yearly basis, or more frequently if affordable, to determine satisfaction and service level gaps with a range of services and features provided, and the demographic and use profile of the park user community. Ideally the customer research should be benchmarked against other organisations.
✗	0.0	Activity Programmes Run on Parks Ongoing resourcing and delivering a range of activity programmes on parks with the intent of increasing community participation and park usage throughout the year.
✗	0.0	Parks Volunteer Programmes An identified resource is provided focused on co-ordinating and supporting volunteer programs in parks, with an appropriate budget to support the activity. Includes maintaining a register of volunteer participants.
✓	2.5	Monitoring of Sports Field Usage Implement booking systems that are capable of reporting participant numbers and hours of use for each sports fields. Analyse data on a seasonal basis to monitor over/under use of sports fields and to assist with determining future field allocation and maintenance regimes.

**Appendix Two – Maintenance quality performance
questionnaire report example**

Parks Maintenance Assessment

Conducted for Shire of Northam



Completed on
09 May 2019 02:29 PM
Park Name
Bernard Park
Category
Social Rec 1
Conducted on
09 May 2019 02:03 PM
Prepared by
Brian Milne

Location
Bernard Park
Northam WA 6401



Score
36/44 - 81%

UNCONFIRMED

Operations and Maintenance - 36/44 - 81%

Question	Response	Details
Does the quality and standard of maintenance of amenity grass areas and edges contribute to the attractiveness and appeal of the site?	2 Good	
		
Does the quality and standard of maintenance of garden areas contribute to the attractiveness and appeal of the site?	4 Poor	
		
Are playgrounds/ fitness equipment and under surfacing functional, safe and well-maintained (eg paint surfaces intact)	2 Good	
		
Is the area free of loose litter and bins not overflowing?	1 Very Good	
Does the standard of maintenance of furniture and structures contribute to	2 Good	

Score (36/44) - 81%
Bernard Park / Shire of Northam

the attractiveness and appeal of the site?	
 Appendix 12 Appendix 13	
Is the furniture and structures free of graffiti?	1 Very Good
Are the trees maintained appropriately with minimal dead wood, good structure and clearance	2 Good
Is the park free of fallen branches?	1 Very Good
Are paths trails and hard surface areas well maintained - even and level, free of pot holes, weeds, subsidence and trip hazards	1 Very Good
Are irrigation systems operating effectively, with even coverage result in healthy uniform(green) growth	1 Very Good
Does the park appear generally well cared for?	2 Good
Photos	
 Appendix 14 Appendix 15	

Score (36/44) - 81%
 Bernard Park / Shire of Northam

Media



Appendix 1



Appendix 2



Appendix 3



Appendix 4

Score (36/44) - 81%
Bernard Park / Shire of Northam



Appendix 5



Appendix 6



Appendix 7



Appendix 8

Score (36/44) - 81%
Bernard Park / Shire of Northam

27

Audit Committee Meeting Minutes
9 October 2019



Appendix 9



Appendix 10



Appendix 11



Appendix 12



Appendix 13



Appendix 14

Score (36/44) - 81%
Bernard Park / Shire of Northam

28

Audit Committee Meeting Minutes
9 October 2019



5.10 AUSTRALASIAN LG PERFORMANCE EXCELLENCE PROGRAM FY18

Address:	N/A
Owner:	N/A
Applicant:	N/A
File Reference:	2.1.2.1
Reporting Officer:	Colin Young Executive Manger corporate Services
Responsible Officer:	Jason Whiteaker Chief Executive Officer
Officer Declaration of Interest:	Nil
Voting Requirement:	Simple Majority
Press release to be issued:	No

BRIEF

In 2016 the Shire of Northam joined the Australasian LG Performance Excellence Program. The program is in essence an opportunity to compare the Shire of Northam across a range of areas with other Local Governments in Western Australia, Australia and New Zealand.

The areas of focus are:

- Workforce;
- Finance;
- Operations;
- Service Delivery;
- Risk management;
- Corporate Leadership; and
- Asset Management.

ATTACHMENTS

Attachment 1: Report - The Australasian LG Performance Excellence Program FY18 (provided as a separate confidential attachment to this report).

A. BACKGROUND / DETAILS

In 2016 the Shire of Northam joined the Australasian LG Performance Excellence Program. The program is in essence an opportunity to compare the Shire of Northam across a range of areas with other Local Governments in Western Australia, Australia and New Zealand.

Audit Committee Meeting Minutes
9 October 2019



The areas of focus are:

- Workforce;
- Finance;
- Operations;
- Service Delivery;
- Risk management;
- Corporate Leadership; and
- Asset Management.

The process for populating the Council data occurred over a period from August 2018 – December 2018, with the information relating to the 2017/18 Financial Year.

Councils Audit Committee recommended the following on the 1 June 2018 based on the Australian LG Performance Excellence Report for the FY 17:

MOTION / COMMITTEE DECISION

Minute No: AU.103

Moved: Cr Proud

Seconded: Cr Mencshelyi

That Council:

1. **Receives the Australasian LG Performance Excellence Program FY17; and**
2. **Includes in the draft 18/19 budget the following areas to be assessed in more detail as part of the internal audit function and reported back to a future Audit Committee Meeting in 2018:**
 - a. **Information Technology resourcing; and**
 - b. **Parks, Gardens & Sporting Grounds resourcing.**
3. **Request the Chief Executive Officer to prepare a brief and obtain quotes to undertake an internal audit on outstanding rates and present this to the next scheduled Audit Committee meeting.**

CARRIED 3/0

B. CONSIDERATIONS

B1 Strategic Community / Corporate Business Plan

Theme Area 6: Governance & Leadership

Outcome 6.3: The Shire of Northam council is a sustainable, responsive, innovative and transparent organisation.

B2 Financial / Resource Implications

There has been staff time committed to populating the database associated with the survey and in analysing the results. It is expected that

further staff resource will be provided to undertake a more detailed assessment of some specific areas.

B3 Legislative Compliance
N/A.

B4 Policy Implications
N/A.

B.5 Stakeholder Engagement / Consultation
N/A.

B.6 Risk Implications

Risk Category	Description	Rating (consequence x likelihood)	Mitigation Action
Financial	Nil	N/A	N/A
Health & Safety	Nil	N/A	N/A
Reputation	Nil	N/A	N/A
Service Interruption	Nil	N/A	N/A
Compliance	Nil	N/A	N/A
Property	Nil	N/A	N/A
Environment	Nil	N/A	N/A

C. OFFICER'S COMMENT

Staff have reviewed the outcomes of the Program and make the following comments:

1. Workforce

FTE per 1,000 residents. Show the Council at 9, compared with 6.5 in the overall WA survey population. However, if you filter the survey population to WA Rural Council's the average is at 7.8, which is comparable with Council's FTE count (noting this is a very small sample size), as per the graph presented below. In essence this highlights that the larger City local governments skew the number of employees per 1,000 employees to the lower result of 6.5. Please note that the FTE is based on the headcount as of the 30 June 2018.



The other relevant factor associated with these numbers is the Council playing a role in the Killara Respite Centre, BKB, Licensing and Visitor Centres. These three areas are not 'usual' local government functions and may further skew the Shire of Northam figures. To put this into context Killara employs 1.4 employees per 1,000, whilst the combined Licensing, BKB and Visitor Centre represents 0.6 (approx.) employees per 1,000 residents.

In addition the Shire of Northam, as 'hang over' from the amalgamation has two swimming pools and libraries, which would be unusual for a rural or regional local government.

- a. Remuneration as a % of operating expenses
 All the comments above remain relevant, although when filtering the results by Rural Local Governments across Australia our percentage of remuneration to operating expenses is slightly lower, being 39% compared with an average of 40% for the WA Survey Population.

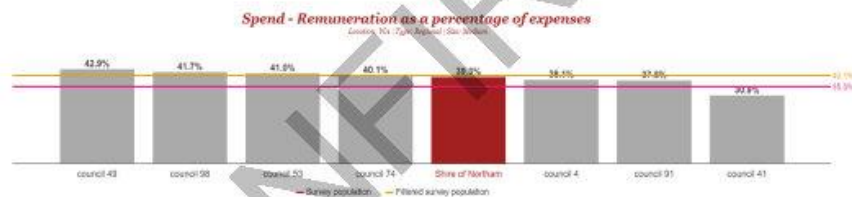

- b. Staff Turnover
 The turnover rate is higher than that the WA Survey population, with Northam being at 22.6%. It is noteworthy to highlight that the turnover numbers are based on number of actual employees employed at 1 July 2017, not number of positions, so having positions vacant at that time will skew the results. It also does not take into account turnover instigated by the Council. Consequently the turnover rates reported to Council regularly are considered more accurate and highlight our performance 12%.

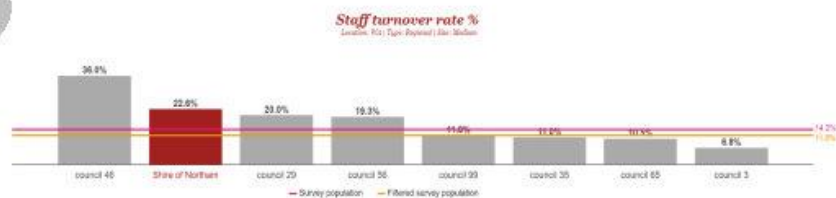

The turnover of employees in the first year of service represents an area to watch to ensure are employment processes are sound,

however as a general comment the employees that left gave reasons beyond Councils control.

c. Median sick leave days

At 6.1 the shire has seen an increase over the 2016/17 year where the result was 3.7, the current years figures are comparable with the WA Survey population showing 5.7, as this position is substantially weaker than the 16/17 staff have assessed for reasons to the increase and it can be attributed to several long term employees requiring substantial time off due to ongoing illness or recovery from operations.

Leave - Sick leave days taken (median)

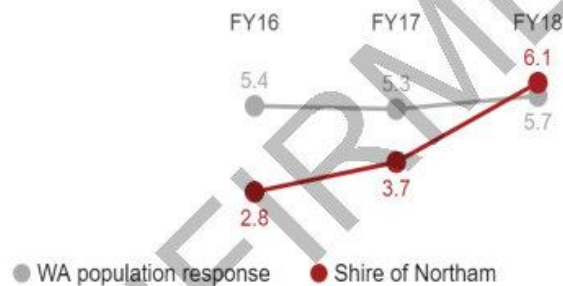

d. Lost Time Injuries

Councils LTI's decreased from 174 to 52 days which is slightly lower than the WA population which is 62, the predominant reason was a notable decrease in incidents which resulted in extended period of absence for individuals during their recovery that occurred in the 2016/17 year.

2. Finance

a. Cost of finance as a % of revenue

This is an area staff are currently investigating, however filtering the data to compare with other WA Regional and Rural Communities indicates that our finance function is only slightly higher than the average, with Northam being 4.3% of revenue whilst the average is 2.2%. It is however noted that Councils finance department includes the position of a Purchasing Officer which is rare within Local Government and supports the whole of the organisation in Procurement.

b. Capital Expenditure Per Resident

Councils current focus on capital expenditure is noticeable here with FY 18 expenditure increasing from the FY 17, (\$690 to \$930), it

Audit Committee Meeting Minutes
9 October 2019



compares favourably to the WA survey population average expenditure of \$660, and \$760 for WA Small to medium Councils.

Capital expenditure (\$) per resident

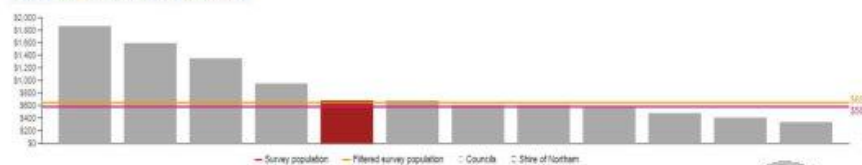

3. Operations

a. Corporate Services staff per 100 employees

At 15.9, this is slightly higher than the entire population survey results of WA at 13.9 and the Rural WA cohort has an average of 13.4. Consideration does need to be given to the structure of our Corporate Services area with licensing being included, a function not undertaken by many local governments, this function equates to approximately 2.45 employees, 2 fulltime plus coverage for leave and lunch breaks.

b. Customer Service staff per 100 employees

Per above comment Councils level is 6.5 compared with the WA average of 3.7 and the Rural WA cohort of 3.5.

c. I/T staff per 100 employees

0.9 I/T staff per 100 employees at the Shire of Northam compares with 3.3 for the WA Average for the entire population and 2.3 for rural and regional WA Councils.

This area Has had an additional 0.6 FTE position added to it in the 2018/19 financial year, the Shire also relies on external support for major works plus backups and are on call through a service agreement when needed. We believe that support in this area is now adequate however it is an area that is constantly being reviewed to ensure it continues to meet the Shires demands.

IT staff per 100 employees



4. Service Delivery

a. Service delivery operating costs and FTE breakdown

The provision of this comparison raises some areas of potential interest, however it also raised a number of queries regarding expenditure per service area with the only area spending less being Governance and Waste Management. This has been further analysed with WA Regional and Rural Communities which is much more consistent with Councils expenditure.

Operating costs per 10,000 residents

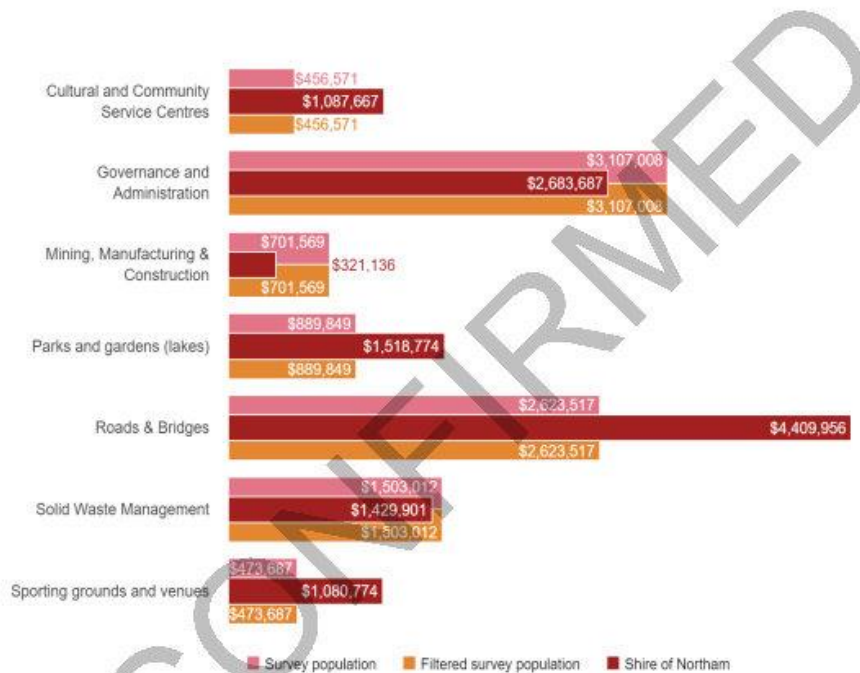

- b. Organizational design by span of control
This highlights the relatively flat structure of the Shire of Northam, which is a positive. Our organisation performs well when compared with others in the context of the number of employees per supervisor/manager.
- c. Solid Waste Management
Council cost of \$137 per resident slightly higher than the average \$136 with the W.A population, indicating our current contract is around market rate.
- d. Roads & Bridges
A breakdown of our roads & bridges cost per kilometre of road indicates Council is either very efficient, or underspending. This more detailed assessment needs to be undertaken in the context of the Council's endorsed asset management plan, which would indicate that our current spend is sufficient to maintain existing service standards. However a more detailed analysis may be advisable. It may

very well be the case that Council is capitalizing more than its peers. The following table compares the Shire of Northam with WA regional rural peers, if this case the average spend is similar excluding depreciation expense.

Roads and Bridges - Breakdown of annual operating costs per kilometre



When interpreting the report it should be noted that the network condition assessment and road categorisation process (Excellent to Very Poor) can vary between Local Governments. For example, some LGA's will have their road network surveyed using Automated Road Analysers (ARAN) with the data managed using software systems (i.e. RAMM in the case of Shire of Northam) Whereas other LGA's may perform visual survey assessments, which leaves condition rating open to interpretation.

In addition when generating works programs from RAMM, variable weightings can be assigned to "Triggers" which will determine condition, severity and proposed treatments.

In recent years the Shire of Northam has assigned higher weightings to cracking which will trigger reseals. This is for the purpose of preventing deterioration of the road to a point where rehabilitation or reconstruction of the road is required, which aligns with the Shire's Asset Management Strategy.

- e. Parks, Gardens and Sporting Grounds

This area was highlighted in the FY 17 for further investigation, figure 4.29 shows that the spend per resident is still high compared to the total survey population, \$260 per person with WA Regional and Rural Communities that is \$103 per person. Council has had a review of the current parks and gardens expenditure carried out; this has been presented to this audit committee meeting.

Parks and sporting grounds - Breakdown of annual operating costs per resident

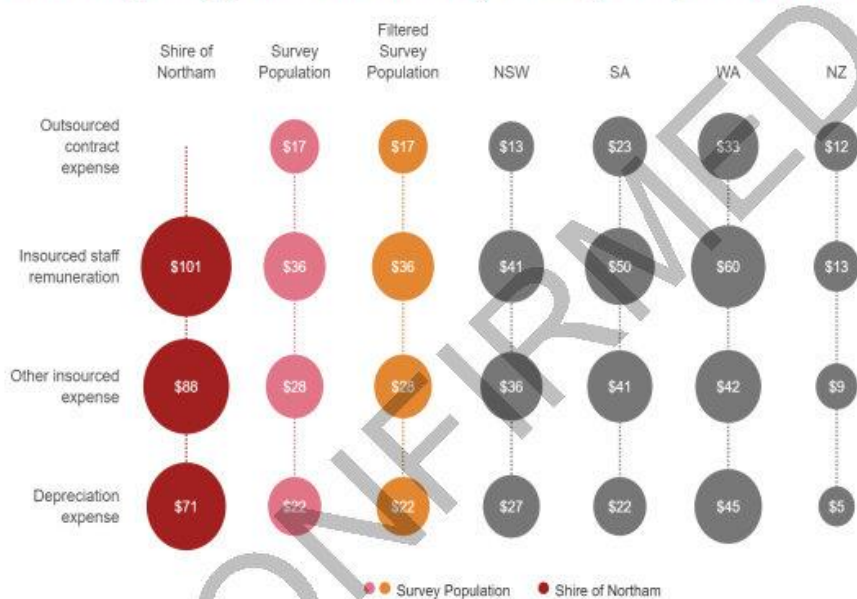

5. Risk Management

a. Internal Audit

An internal audit function is in place and during the year two audits were performed being an ICT Audit and a Service levels Audit of the Shires Parks and Gardens.

b. Risk Management

At the time of reporting Council did not have a risk policy in place, however a risk policy was recently endorsed by Council to guide staff and report the risks to council.

6. Corporate Leadership

No specific areas requiring comment or focus

7. Asset Management

No specific areas requiring comment or focus

Audit Committee Meeting Minutes
9 October 2019



Council recommended on the 1 June 2018 that more detailed assessments would be carried out on the following areas of which both were carried out during 2018/19;

1. Information Technology and Reporting
2. Parks, Gardens & Sporting Grounds Resourcing

In addition council requested the CEO obtain quotes for an internal audit on rates outstanding, staff have had internal discussions relating to the outstanding debt, based around putting strategies in place or incentives to encourage payment, as such staff are now recommending that Council discuss strategies at a workshop or through a number of workshops.

It was requested by the Shire President that a detailed analyse be carried out on total outstanding leave. The following table details total outstanding annual leave as per the 30 June 2019.

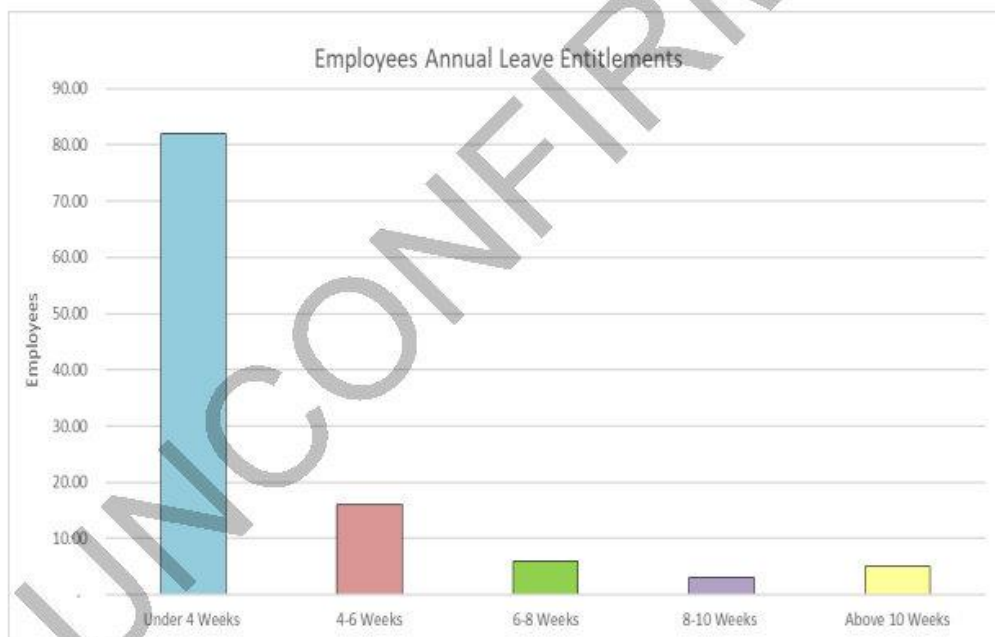

Total Outstanding leave is \$605K, with the majority of Council staff having under 4 weeks, staff with greater than 8 weeks due are currently encouraged to use their leave.

Audit Committee Meeting Minutes
9 October 2019



The following table is for outstanding long Service Leave liability as of the 30 June 2019.

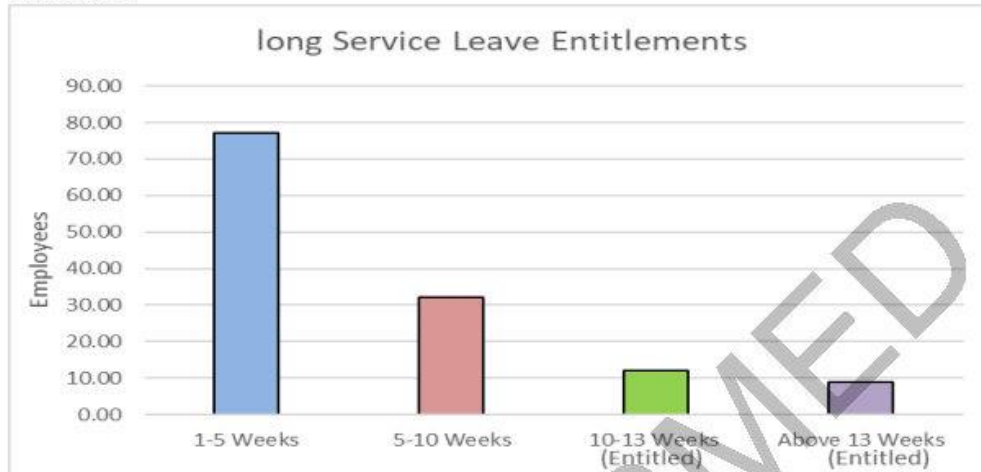

Total outstanding Long Service Leave (LSL) is \$837K, which is further broke up into Current \$615K and non-current \$222K. Three staff members with due LSL (above 13 weeks) have indicated that it will be taken during the 2019/20 financial year.

RECOMMENDATION / COMMITTEE DECISION

Minute No: AU.132

Moved: Cr Antonio
Seconded: Cr Mencshelyi

That Council:

1. Receives the Australasian LG Performance Excellence Program FY18; and
2. Requests that the CEO arrange a workshop to discuss the outstanding rate debt.
3. Request the CEO to present a policy to Council to manage employee annual and long service leave.

CARRIED 2/0

Discussion was held around employee leave. The Executive Manager Corporate Services advised that there is still a large monetary value outstanding which is increasing annually, this is something that is being monitored by staff. It was advised that staff are encouraged to use their leave. Clarification was sought in relation to whether this can be cashed, the

Audit Committee Meeting Minutes
9 October 2019



Executive Manager Corporate Services advised that this is permitted however they must enter into a Deed of Compromise.

Discussion was held around developing a policy to manage leave and including some timeframes around this. This was incorporated into the recommendation/committee decision.

It was noted that this should be documented as a risk on the Shire's Risk Register.

Discussion was held around the outstanding rates audit. The Executive Manager Corporate Services outlined that a workshop is proposed to discuss a few ideas to manage this.

Discussion was held participating in the program in future years. The Executive Manager Corporate Services outlined that there is nothing new highlighted and therefore it is not recommended to participate in the program in future years.

5.11 FINANCIAL MANAGEMENT REVIEW

Address:	N/A
Owner:	Internal report Shire of Northam
Applicant:	As Above
File Reference:	8.2.7.1
Reporting Officer:	Colin Young Executive Manager Corporate Services
Responsible Officer:	Colin Young Executive Manager Corporate Services
Officer Declaration of Interest:	Nil
Voting Requirement:	Simple Majority
Press release to be issued:	Nil

BRIEF

For the Audit Committee to receive the Financial Management System Review report that was conducted by AMD Chartered Accounts on the 10-13 June 2019.

ATTACHMENTS

Attachment: 2019 FMSR Report Shire of Northam.

A. BACKGROUND / DETAILS

Council's Financial Management Systems Review was undertaken on 10-13 June 2019 by AMD Chartered Accountants. In accordance with Regulation 5(2)(c) of the *Local Government Financial Management Regulations 1996* Council is required to have a review of its financial system to ensure its appropriateness and effectiveness at least once every three years.

This report is to provide Council the information and suggested action that is contained within the Financial Management Review.

B. CONSIDERATIONS

B.1 Strategic Community / Corporate Business Plan

Theme Area 6: Governance & Leadership.

Outcome 6.3: The Shire of Northam council is a sustainable, responsive, innovative and transparent organisation.

Objective:

- Ensure robust financial management.
- Implement systems and processes which deliver outcomes for our community.

- Maintain a high standard of corporate governance.

B.2 Financial / Resource Implications

Nil

B.3 Legislative Compliance

Local Government Act (1995) Section 7.12A & Local Government Financial Management Regulations 1996 Regulation 5(2)(c)

B.4 Policy Implications

N/A.

B.5 Stakeholder Engagement / Consultation

Nil.

B.6 Risk Implications

Risk Category	Description	Rating (consequence x likelihood)	Mitigation Action
Financial	Nil	N/A	N/A
Health & Safety	Nil	N/A	N/A
Reputation	Nil	N/A	N/A
Service Interruption	Nil	N/A	N/A
Compliance	Non-Compliance with Act if FMSR not carried out.	Moderate(5)	Compliance calendar in place.
Property	Nil	N/A	N/A
Environment	Nil	N/A	N/A

C. OFFICER'S COMMENT

The Auditor raised a number of findings within the Financial Management Systems Review that need to be addressed to ensure that best practices are being followed by Council. The following comprises the issues raised, the auditors recommendations on the best way to resolve them and managements comments. The level of risk for eight of the issues were considered moderate and five raised were low.

1. Collection of money

The daily banking sheet is not signed by the preparer, nor is there evidence of independent review.

Recommendation

Daily banking reconciliations should be consistently prepared, signed by the preparer and adequately reviewed on a daily basis by an independent senior management staff member. The daily banking reconciliation should be signed as evidence the independent review has occurred.

Management comment

The daily banking is prepared by an Administration Officer. The amounts are checked during the Bank Reconciliation process daily. The Bank reconciliation process is undertaken by the Senior Finance Officer or Rates Officer the following day to ensure the amounts match the bank statement in a timely manner. We will ensure the signing by Officers is incorporated into the process.

2. Custody and security of money

Physical security of cash

Suggestions for enhancements to improve security of cash takings across various Shire controlled sites

Recommendation

- Processes with respect to cash handling and physical storage at Shire managed locations be reviewed with an objective of enhancing controls over Council monies.
- Council consider engaging a cash-in-transit security service provider or alternatively set a pre- determined maximum cash-in-transit daily banking amount to reduce the risk.
- Banking for Shire managed locations be completed at least weekly.
- A receipt or acknowledgement of cash provided for banking be received by Shire managed locations.

Management comment

The Shire will consider installing small safes at Killara, the Northam Library and BKB Centre

- The procedure for high volume cash periods, is generally only around four days a year on the final day of rates instalments falling due. Moving cash from tills in the front counter is recorded and counted and signed for by two staff members, then placed in a locked safe. During these times two staff take the cash to the bank.
- Reminders and regular checks and follow ups will be made to ensure banking is done at least weekly
- Where banking is brought to the Administration Building for receipting, the staff member bringing the money is to sign the paperwork that accompanies the money and the staff member counting it will also sign and date it.

Petty cash reconciliations

Minor variances were identified when completing petty cash counts at cash collection sites operated by the Shire

Recommendation

Petty cash is reconciled on a regular basis and any variances identified be investigated and rectified in a timely manner.

Management comment

Staff will be notified and will sign the end of year reconciliation forms that will be amended to require a minimum of quarterly submissions be made for reimbursements and that the petty cash be counted at the end of every month

3. Maintenance and security of financial records

4. Business Continuity Plan

The Shire does not have a Business Continuity Plan.

Recommendation

The existing Business Continuity Plan was developed in February 2016 and requires updating. It is recommended that the Plan be reviewed, approved and subsequently implemented by the Shire. In addition, the DRP should subsequently be tested on a periodic basis to ensure that in the event of a disaster, appropriate action(s) can be taken.

Management comment

The Formal documentation of Disaster Recovery Actions will be undertaken.

Interim rates

Interim Rate notices are not issued throughout the year on a timely basis by the Shire when Landgate updates the property valuations

Recommendation

Interim rate notices be issued in a timely manner upon receipt of updated property valuations from Landgate.

Management comment

Noted, procedures will be put in place to ensure interim rates are processed in a more timely manner.

Terminated employee access

There is no formal procedure in place to ensure network access is disabled for terminated employees.

Recommendation

A termination checklist be completed for all terminated employees, including ensuring network access is disabled.

Management comment

Synergy Access uses a process of replacement of a terminating officer with a replacement officer, so it is not possible for access remotely or to the financial system.

A checklist for new starters and terminations, that incorporates Council property and its condition of use to be developed. Boxes to include IT accesses and permissions and signed by the Manager.

5. Authorisation for incurring liabilities and making payments

Tenders, purchases and payments

Testing found exceptions where tender and payment procedures had not been complied with.

Recommendation

- The Tender Register be updated throughout the tendering process.
- A tender checklist be completed for all tenders.
- All creditor and EFT payment batch listings be consistently signed as evidence of independent review and approval.

Management comment

Noted, procedures will be reviewed.

Store and fuel cards

Inquiries indicated there is no documented "Terms of Use Agreement" in place with Shire employees who have been allocated store and / or fuel cards.

Recommendation

All store and / or fuel card holders sign an agreement with the Shire outlining their acknowledgment of acceptable use of the store / fuel card in accordance with statement policy. This agreement should also outline procedures relating to when a cardholder is on extended leave or absent from the Shire.

Management comment

To be covered in the induction and termination document as detailed above

Credit card usage agreement

Credit card holders are not required to sign a 'user agreement' or

'policy acknowledgement' document'.

Recommendation:

An agreement should be signed by credit card holders and the Shire setting out the card holders' responsibilities in terms of the Shire's policy and Local Government guidelines.

Management comment

To be covered in the new starter induction and termination document as detailed above

6. Maintenance of payroll, stock control and costing

Fuel usage analysis

Observation of Dunnings fuel statements identified that although these are reviewed on an individual report basis, the Shire is currently not holistically analysing fuel usage by asset for inappropriate use i.e. there is no analysis to review fuel usage on an overall basis for each asset, on a periodic or sample basis.

Recommendation

The Shire investigate an appropriate method to analyse the use of fuel holistically. This spreadsheet should capture each Shire motor vehicle and detail every transaction in a chronological order. Once established, the fuel usage per asset could be analysed to determine whether the employee is fuelling up several times a day, over the weekend, late at night or if excessive fuel purchased against the expected route the employee is travelling etc.

Management comment

Noted, will review current procedures.

Payroll exceptions

During the payroll testing, it was noted there were exceptions pertaining to the audit sample of reports and employee deductions.

Recommendation

- All payroll reports be independently reviewed and evidence of this review is documented in the form of a physical sign-off;
- Termination checklists be completed for all terminated employees, reviewed and approved by the management; and
- All deductions from employee wages are supported by an authorised deduction form.

Management comment

- All payroll reports are now signed. The checks and balances are all

Audit Committee Meeting Minutes
9 October 2019



- done. However previously not signed.
- All terminations are signed as checked by the Accountant. Termination Form to be developed
 - The process for deductions has been changed to file all amendments in personnel files as per the recommendation.

Excessive leave balances

Review of annual leave accrual as at 30 April 2019 indicated instances where seven employees had annual leave accrued balances in excess of 300 hours each.

Recommendation

Employees take regular leave through ongoing management of leave scheduling and leave liabilities.

Management comment

Noted, leave balances will continue to be monitored

7. Preparation of budgets, budget reviews, accounts and reports required by the Act or the Regulations

The scope and approach to the Budget preparation, review and reports was examined to ensure compliance and efficiency. It noted the Shire's Risk Management Policy was due for review in 2017 and still references the former AS/NZS 31000:2009 standard as opposed to the updated version AS/ISO 31000:2018.

Recommendation

The Shire review and update the Risk Management Policy accordingly.

Management comment

Policy will be updated.

Guidance on Risk Assessment was provided as per Guidelines Standard AS ISO 31000-2018 and noted.

RECOMMENDATION / COMMITTEE DECISION

Minute No: AU.133

Moved: Cr Antonio

Seconded: Cr Mencshelyi

That Council receive the Financial Management Systems Review report for 2018/19 and require the progress of the recommended actions to be reported to the audit committee until all items are complete

CARRIED 2/0

The Executive Manager Corporate Services advised that the items identified are believed to be minor and staff have already put measures in place for these. In relation to a safe at the BKB, it was advised that staff are comfortable with this being in a locked draw as they are only taking \$40 per day on average. Given it is not a large amount of cash, it is not believed to be worthwhile installing a safe. Discussion was held around using Armor Guard for Council's facilities however it is not believed to be necessary given large amounts of cash are not taken.



2019 Financial Management System Review

Shire of Northam

June 2019



Audit Committee Meeting Minutes
9 October 2019



28 June 2019

Mr J Whittaker
Chief Executive Officer
Shire of Northam
PO Box 613
NORTHAM WA 6401

Dear Jason

2019 FINANCIAL MANAGEMENT SYSTEMS REVIEW

We are pleased to present the findings and recommendations resulting from the Shire of Northam (the "Shire") Local Government (Financial Management) Regulation 1996, Financial Management System Review.

This report relates only to procedures and items specified within the 2019 Financial Management System Review Services Proposal and does not extend to any financial report of the Shire.

We would like to thank Colin, Zoe and the finance team for their co-operation and assistance whilst conducting our review.

Should there be matters outlined in our report requiring clarification or any other matters relating to our review, please do not hesitate to contact Deon Marcus or myself.

Yours sincerely
AMD Chartered Accountants

TIM PARTRIDGE FCA
Director

AMD Audit & Assurance Pty Ltd
ACN 145 719 259 t/a AMD
Liability limited by a scheme approved
under Professional Standards Legislation

T +61 (8) 9780 7555
F +61 (8) 9721 8982
E amd@amdonline.com.au
www.amdonline.com.au

Unit 1, 28-30 Wellington Street,
Bunbury, WA 6230
PO Box 1306, Bunbury, WA 6231



Table of Contents

1. Executive Summary	5
1.1. Background and Objectives	5
1.2. Summary of Findings	5
2. Collection of money.....	7
2.1. Scope and approach	7
2.2. Detailed findings and recommendations	7
2.2.1. Daily banking reconciliations and cash handling/receipting	7
3. Custody and security of money	8
3.1. Scope and approach	8
3.2. Detailed findings and recommendations	8
3.2.1. Physical Security of Cash	8
3.2.2. Petty Cash Reconciliation	9
4. Maintenance and security of the financial records.....	10
4.1. Scope and approach	10
4.2. Detailed findings and recommendations	10
4.2.1. IT Disaster Recovery Plan	10
4.2.2. Interim Rates	11
4.2.3. Terminated Employees Network Access	11
5. Accounting for municipal or trust transactions	12
5.1. Scope and approach	12
5.2. Detailed findings and recommendations	12
6. Authorisation for incurring liabilities and making payments	13
6.1. Scope and approach	13
6.2. Detailed findings and recommendations	13
6.2.1. Tenders, Purchases and Payments	13
6.2.2. Store and Fuel Cards.....	14
6.2.3. Credit Card Usage Agreement.....	14
7. Maintenance of payroll, stock control and costing.....	15
7.1. Scope and approach	15
7.2. Detailed findings and recommendations	15
7.2.1. Fuel Usage Analysis	15
7.2.2. Payroll Exceptions.....	16
7.2.3. Excessive Leave Balances.....	17
8. Preparation of budgets, budget reviews, accounts and reports required by the Act or the Regulations.....	18
8.1. Scope and approach	18
8.2. Detailed findings and recommendations	18
8.2.1 Risk Management Policy.....	18
9. Guidance on Risk Assessment	19

Audit Committee Meeting Minutes
9 October 2019



Inherent limitations

Due to the inherent limitations of any internal control structure, it is possible that fraud, error or non-compliance with laws and regulations may occur and not be detected. Further, the internal control structure, within which the control procedures that have been subject to review, has not been reviewed in its entirety and, therefore, no opinion or view is expressed as to its effectiveness of the greater internal control structure. This review is not designed to detect all weaknesses in control procedures as it is not performed continuously throughout the period and the tests performed on the control procedures are on a sample basis. Any projection of the evaluation of control procedures to future periods is subject to the risk that the procedures may become inadequate because of changes in conditions, or that the degree of compliance with them may deteriorate.

We believe that the statements made in this report are accurate, but no warranty of completeness, accuracy or reliability is given in relation to the statements and representations made by, and the information and documentation provided by, Shire of Northam management and personnel. We have indicated within this report the sources of the information provided. We have not sought to independently verify those sources unless otherwise noted with the report. We are under no obligation in any circumstance to update this report, in either oral or written form, for events occurring after the report has been issued in final form unless specifically agreed with the Shire of Northam. The review findings expressed in this report have been formed on the above basis.

Third party reliance

This report was prepared solely for the purpose set out in this report and for the internal use of the management of the Shire of Northam. This report is solely for the purpose set out in the 'Scope and Approach' of this report and for the Shire of Northam's information, and is not to be used for any other purpose or distributed to any other party without AMD's prior written consent. This review report has been prepared at the request of Shire of Northam's Chief Executive Officer or its delegate in connection with our engagement to perform the review as detailed in the 2019 Financial Management System Review Services Proposal. Other than our responsibility to the Council and management of the Shire of Northam, neither AMD nor any member or employee of AMD undertakes responsibility arising in any way from reliance placed by a third party, including but not limited to the Shire of Northam external auditors, on this review report. Any reliance placed is that party's sole responsibility.

UNCONFIRMED



1. Executive Summary

1.1. Background and Objectives

The primary objective of our Financial Management System Review (FMSR) was to assess the adequacy and effectiveness of systems and controls in place within the Shire focusing on accounts payable, accounts receivable, human resources and payroll procedures; in accordance with the 2019 Financial Management System Review Services Proposal (the "Review").

The responsibility of determining the adequacy of the procedures undertaken by us is that of the Chief Executive Officer (CEO). The procedures were performed solely to assist the CEO in satisfying his duty under Section 6.10 of the Local Government Act 1995 and Regulation 5(1) of the Local Government (Financial Management) Regulations 1996.

Our findings included within this report are based on the site work completed by us on the 10 June to 13 June 2019. Findings are based on information provided and available to us during and subsequent this site visit.

1.2. Summary of Findings

The procedures performed and our findings on each of the focus areas are detailed in the following sections of the report:

- Section 2 - Collection of money;
- Section 3 - Custody and security of money;
- Section 4 - Maintenance and security of the financial records;
- Section 5 - Accounting for municipal or trust transactions;
- Section 6 - Authorisation for incurring liabilities and making payments;
- Section 7 - Maintenance of payroll, stock control and costing records; and
- Section 8 - Preparation of budgets, budget reviews, accounts and reports required by the Act or the regulations.

Following the completion of our review and subject to the recommendations outlined within sections 2 to 8, we are pleased to report that in context of the Shire's overall internal control environment, policies, procedures and processes in place are appropriate, and have been operating effectively at the time of the review.

Findings reported by us are on an exceptions basis, and do not take into account the many focus areas tested during our review where policies, procedures and processes were deemed to be appropriate and in accordance with better practice.

The following tables provide a summary of the findings raised in this report:

	Extreme Risk	High Risk	Moderate Risk	Low Risk
Number of new issues reported	0	0	8	5

For details on the review rating criteria, please refer to Section 9.

Audit Committee Meeting Minutes
9 October 2019



Ref	Issue	Risk Rating
2. Collection of money		
Daily banking reconciliations and cash handling/receipting		
2.2.1	The daily banking sheet prepared each morning as part of the banking process is not signed by the preparer nor is there evidence of independent review.	Moderate
3. Custody and security of money		
Physical Security of Cash		
3.2.1	Suggestions for enhancements to improve security of cash takings across various Shire controlled sites.	Moderate
Petty Cash Reconciliation		
3.2.2	Minor variances identified when completing petty cash counts at cash collection sites operated by the Shire.	Low
4. Maintenance and security of financial records		
Business Continuity Plan		
4.2.1	The Shire does not currently have a Business Continuity Plan.	Moderate
Interim Rates		
4.2.2	Interim rate notices not issued throughout the year on a timely basis by the Shire when Landgate updates the property valuation.	Low
Terminated Employees Network Access		
4.2.3	There is no formal procedure in place to ensure network access is disabled for terminated employees.	Low
5. Accounting for municipal or trust transactions		
We have no findings to raise in respect to accounting for municipal or trust transactions.		
6. Authorisation for incurring liabilities and making payments		
Tenders, Purchases and Payments		
6.2.1	Our testing identified exceptions where tender and payment procedures had not been complied with.	Moderate
Store and Fuel Cards		
6.2.2	There is no documented "Terms of Use Agreement" in place with Shire employee's allocated store and / or fuel cards.	Moderate
Credit Card Usage Agreement		
6.2.3	Credit card holders are not required to sign a 'user agreement' or 'policy acknowledgement' document.	Moderate
7. Maintenance of payroll, stock control and costing records		
Fuel Usage Analysis		
7.2.1	Further enhancement of the Shire's fuel usage analysis is recommended.	Moderate
Payroll Exceptions		
7.2.2	Our testing identified exceptions where payroll procedures had not been complied with.	Moderate
Excessive Leave Balances		
7.2.3	Review of annual leave accrual indicated instances where employees had excessive leave balances.	Low
8. Preparation of budgets, budget reviews, accounts and reports required by the Act or the Regulations		
Risk Management Policy		
8.2.1	Review of current Risk Management Policy to ensure compliance with current risk standard.	Low



2. Collection of money

2.1. Scope and approach

For the following locations operated by the Shire including:

- Northam Administration Office;
- Northam Recreation Centre;
- Northam Public Library;
- Northam Visitor Centre;
- Killara Adult Day Care and Respite Centre;
- Bilya Koort Boodja Centre;
- Old Quarry Waste Facility; and

We:

- Documented internal controls, procedures and reconciliations in relation to all sources of income;
- Counted petty cash and float on hand ensuring materially correct;
- Reviewed fees and charges schedule and ensure adequate internal controls in place over receipting;
- Tested collection, receipting, invoicing and posting procedures over cash receipts on a sample basis; and
- Reviewed credit control procedures in respect to sundry debtors and rate debtors.

2.2. Detailed findings and recommendations

2.2.1. Daily banking reconciliations and cash handling/receipting

Finding Rating: Moderate

Finding

Section 7.3 of the Western Australian Local Government Accounting Manual Edition 3 issued by the Department Local Government in September 2012 outlines the minimum level of monitoring and control activities for key risk areas. Paragraph 4(h) states "Reconciliation of daily deposit total to receivable posting and cash sales is prepared and reviewed."

During our daily banking testing, we identified the daily banking sheet prepared each morning as part of the banking process is not signed by the preparer nor is there evidence of independent review.

Implication / Risks

If the daily banking reconciliation is not independently reviewed, there is an increased risk of errors and omissions remaining undetected, which in turn could lead to misstatements in the Shire's financial reporting.

Recommendation

Daily banking reconciliations should be consistently prepared, signed by the preparer and adequately reviewed on a daily basis by an independent senior management staff member. The daily banking reconciliation should be signed as evidence the independent review has occurred.

Management Comment

The daily banking is prepared by an Administration Officer. The amounts are checked during the Bank Reconciliation process daily. The Bank reconciliation process is undertaken by the Senior Finance Officer or Rates Officer the following day to ensure the amounts match the Bank statement in a timely manner. We will ensure the signing by Officers is incorporated into the process.

Responsible Officer: Senior Finance Officer

Completion Date: 31.07.2019



3. Custody and security of money

3.1. Scope and approach

- Conducted site visits of cash collection points to review the controls and procedures over the collection, receipting, recording and banking of cash collected offsite; and
- Reviewed the security of cash and banking procedures to ensure the appropriate controls and procedures are in place.

3.2. Detailed findings and recommendations

3.2.1. Physical Security of Cash *Finding Rating: Moderate*

We noted the following in respect to security of cash takings and / or petty cash:

- The Killara Adult Day Care Centre and Respite Centre, the Northam Public Library and the Bilya Koort Boodja Centre; cash on hand including till floats and petty cash where applicable is maintained in locked filing cabinet drawers when not in use, rather than locked in a safe.
- Review of a sample of daily banking indicated a significant amount of physical cash is handled, in particular in rate payment period (at times in excess of \$17,500). The handling of a significant amount of cash in transit by Shire staff is a security risk and potentially affects the safety of Shire employees.
- The Killara Adult Day Care and Respite Centre still held cash received on the 12 April 2019 at the time of our 11 June 2019 site visit resulting in funds not being banked or received in the general ledger.
- The Northam Public Library, Northam Visitor Centre and Bilya Koort Boodja Centre do not receive a receipt or acknowledgement at the time banking is provided to the Northam Administration Office.

Implications / Risks

- Lack of appropriate internal controls over the security of cash collected and Council funds resulting in an increased risk of theft.
- Risk that error or fraud may not be detected on a timely basis.

Recommendation

We recommend:

- Processes with respect to cash handling and physical storage at Shire managed locations be reviewed with an objective of enhancing controls over Council monies.
- Council consider engaging a cash-in-transit security service provider or alternatively set a pre-determined maximum cash-in-transit daily banking amount to reduce the risk.
- Banking for Shire managed locations be completed at least weekly.
- A receipt or acknowledgement of cash provided for banking be received by Shire managed locations.

Management Comment

- The Shire will consider installing small safes at Killara, the Northam Library and BKB Centre
- The procedure for high volume cash periods, is generally only around four days a year on the final day of rates instalments falling due. Moving cash from tills in the front counter is recorded and counted and signed for by two staff members, then placed in a locked safe. During these times two staff take the cash to the bank.
- Reminders and regular checks and follow ups will be made to ensure banking is done at least weekly.

Audit Committee Meeting Minutes
9 October 2019



- Where banking is brought to the Administration Building for receipting, the staff member bringing the money is to sign the paperwork that accompanies the money and the staff member counting it will also sign and date it.

Responsible Officer: Senior Finance Officer

Completion Date: 31.07.2019

3.2.2. Petty Cash Reconciliation

Finding Rating: Low

We completed a count of cash on hand and petty cash at each location we visited and noted the following variances:

Location	Cash Counted (\$)	Purchase (\$)	Total (\$)	Petty Cash Float (\$)	Variance (\$)
Northam Visitor Centre	128.65	67.80	196.45	200	3.55 under
Bilya Koort Boodja Centre	61.40	91.10	152.50	150	2.50 over
Northam Recreation Centre	132.40	90.20	202.60	200	2.60 over

Implications / Risks

Risk of misstatement or omission.

Recommendation

We recommend petty cash is reconciled on a regular basis and any variances identified be investigated and rectified in a timely manner.

Management Comment

Staff will be notified and will sign the end of year reconciliation forms that will be amended to require a minimum of quarterly submissions be made for reimbursements and that the petty cash be counted at the end of every month.

Responsible Officer: Accountant

Completion Date: 07.07.2019



4. Maintenance and security of the financial records

4.1. Scope and approach

- Reviewed information technology systems to assess physical security, access security, data backups, contingency plans, compliance and systems development; and
- Reviewed registers maintained (including key register, tender register, gifts and travel registers etc.) and Council minutes.

Please note, our inquiries indicated no major IT projects have been completed at the time of our site visit; therefore our assessment of IT projects undertaken by the Shire of Northam from the planning to contractor selection to inception phase was limited.

4.2. Detailed findings and recommendations

4.2.1. IT Disaster Recovery Plan

Finding Rating: Moderate

The Shire does not currently have a formalised documented IT disaster recovery plan (DRP) in place.

Implications / Risks

If the Shire does not have a formalised documented DRP in place, which is subsequently tested on a periodic basis, there is a risk of significant delays and business interruption in the event of unforeseen circumstances in respect to the Shire's business.

Recommendation

We recommend a DRP be developed, approved and subsequently implemented by the Shire. In addition, the DRP should subsequently be tested on a periodic basis to ensure that in the event of a disaster, appropriate action(s) can be taken.

Management Comment

The Formal documentation of Disaster Recovery Actions will be undertaken.

Responsible Officer: EMCS

Completion Date: 30.11.2019

Audit Committee Meeting Minutes
9 October 2019



4.2.2. Interim Rates
Finding Rating: Low

While conducting rates testing, we identified instances where interim rate notices were not issued throughout the year by the Shire on a timely basis when Landgate updates the property valuation. For example, review of the interim rates notice register indicated interim rate notice G2019/2 had been processed before interim rates notices G2018/6 and G2018/7.

Implication / Risk

Where interim rates are not issued on a timely basis there is risk of either not recording/collecting all revenue during the financial period or potentially overcharging the rate payer which could impact on the Shire reputation amongst the community.

Recommendation

We recommend interim rate notices be issued in a timely manner upon receipt of updated property valuations from Landgate.

Management Comment

Noted, procedures will be put in place to ensure interim rates are processed in a more timely manner.

Responsible Officer: Rates Officer **Completion Date:** 30.06.2019

4.2.3. Terminated Employees Network Access
Finding Rating: Low

Our inquiries identified there is no formal procedure in place to ensure network access is disabled for terminated employees.

Implication / Risk

Risk of unauthorised access to the Shire's network.

Recommendation

We recommend a termination checklist be completed for all terminated employees, including ensuring network access is disabled.

Management Comment

Synergy Access uses a process of replacement of a terminating officer with a replacement officer, so it is not possible for access remotely or to the financial system.

A checklist for new starters and terminations, that incorporates Council property and its condition of use to be developed. Boxes to include IT accesses and permissions and signed by the Manager.

Responsible Officer: Human Resources Manager **Completion Date:** 31.07.2019



5. Accounting for municipal or trust transactions

5.1. Scope and approach

- Reviewed all monthly reconciliations including bank, sundry debtors, sundry creditors, fixed assets, rates debtors and rateable value reconciliations ensuring correctly reconciled and reviewed;
- Reviewed and tested in detail most recent municipal and trust bank reconciliations prepared;
- Reviewed processes in respect to BAS, FBT Return and other statutory returns preparation;
- Reviewed use of reserve funds and determined whether changes in reserve purposes have been budgeted or public notice was provided;
- Reviewed self-supporting loan transactions ensuring debtor invoices raised in accordance with payment schedule;
- Reviewed trust ledger balances; and
- Reviewed policies and procedures in respect to insurance, recording claims and insuring newly acquired assets.

5.2. Detailed findings and recommendations

Our review indicated key underlying policies and processes in relation to accounting for municipal or trust transactions are appropriate, in line with best practice and operating effectively.

Accordingly, we have no recommendations to raise in respect to accounting for municipal or trust transactions.



6. Authorisation for incurring liabilities and making payments

6.1. Scope and approach

- Reviewed controls and procedures over the authorisation of purchase orders and making of payments;
- Tested sample of payments to ensure compliance with stated procedures;
- Reviewed credit card processes and procedures, and testing transactions on a sample basis;
- Reviewed petty cash processes and procedures, and testing transactions on a sample basis;
- Completed sample testing of asset additions and asset disposals;
- Reviewed asset capitalisation and depreciation policy and ensure compliance with stated policies; and
- Reviewed new loans received ensuring budgeted for or public notice provided.

6.2. Detailed findings and recommendations

6.2.1. Tenders, Purchases and Payments

Finding Rating: Moderate

Our testing of a sample of purchases and tenders identified the following:

Tender 5 of 2018

- The Shire's tender checklist had not been completed;
- The tender register did not indicate the date of the Council decision;
- The tender register did not indicate the names of unsuccessful tenders; and
- The tender register did not indicate the details of the successful tenderer.

EFT payments batch 10 May 2019

- The Synergy report 'Creditors to be Paid' had been reviewed, however there was no signature evidence to indicate the independent review had occurred;
- The Bankwest 'Payment File Upload' report did not indicate any evidence of independence review or approval by payment authorities; and
- The Bankwest 'Payment Receipt' report had not been signed by the second payment authority.

Implications / Risks

- Risk of non-compliance with the Shire's Purchasing Policy.
- Risk the Shire is unable to demonstrate compliance with the Local Government Regulations.

Recommendation

We recommend:

- The Tender Register be updated throughout the tendering process.
- A tender checklist be completed for all tenders.
- All creditor and EFT payment batch listings be consistently signed as evidence of independent review and approval.

Management Comment

Noted, procedures will be reviewed

Responsible Officer: Accountant

Completion Date: 31.07.2019

Audit Committee Meeting Minutes
9 October 2019



6.2.2. Store and Fuel Cards
Finding Rating: Moderate

Our inquiries indicated there is no documented "Terms of Use Agreement" in place with Shire employees who have been allocated store and / or fuel cards.

Implications / Risks

Increased risk that Terms of Use have not been understood and complied with.

Recommendation

We recommend all store and / or fuel card holders sign an agreement with the Shire outlining their acknowledgment of acceptable use of the store / fuel card in accordance with statement policy. This agreement should also outline procedures relating to when a cardholder is on extended leave or absent from the Shire.

Management Comment

To be covered in the induction and termination document as detailed above 4.2.3

Responsible Officer: Human Resources Manager **Completion Date:** 31.07.2019

6.2.3. Credit Card Usage Agreement
Rating: Moderate

Finding:

Credit card holders are not required to sign a 'user agreement' or 'policy acknowledgement' document'.

Implication:

Increased risk of fraud and non-compliance with Council policy HR 2.7 Credit Card Use and Local Government Operational Guideline Number 11 – Use of Corporate Credit Cards.

Recommendation:

An agreement should be signed by credit card holders and the Shire setting out the card holders' responsibilities in terms of the Shire's policy and Local Government guidelines.

Management Comment:

To be covered in the new starter induction and termination document as detailed above 4.2.3

Responsible Person: Human Resources Manager **Completion Date:** 31.07.2019



7. Maintenance of payroll, stock control and costing

7.1. Scope and approach

- Completed site visit to the Northam depot to review security over stocks held and allocation / costings of stocks used (including fuel and inventory stocks);
- Reviewed of the allocation of public works overheads, plant operating costs and administration overheads completed;
- Reviewed payroll controls and procedures to ensure effective controls are in place, and complete tests on a sample basis to ensure these controls were operating effectively;
- Reviewed procedures and policies in place in respect of human resource management legislative and compliance requirements, recruitment, performance appraisal, disciplinary and termination procedures and leave entitlements;
- Reviewed listing of leave taken by employees ensuring authorised leave forms completed; and
- Reviewed annual leave balances and identify employees with more than eight weeks annual leave.

7.2. Detailed findings and recommendations

7.2.1. Fuel Usage Analysis

Finding Rating: Moderate

Observation of Dunnings fuel statements identified that although these are reviewed on an individual report basis, the Shire is currently not holistically analysing fuel usage by asset for inappropriate use i.e. there is no analysis to review fuel usage on an overall basis for each asset, on a periodic or sample basis.

Implications / Risks

Risk of fuel misappropriation.

Recommendation

We recommend the following:

- The Shire investigate an appropriate method to analyse the use of fuel holistically. This spreadsheet should capture each Shire motor vehicle and detail every transaction in a chronological order. Once established, the fuel usage per asset could be analysed to determine whether the employee is fuelling up several times a day, over the weekend, late at night or if excessive fuel purchased against the expected route the employee is travelling etc

Management Comment

Noted, will review current procedures.

Responsible Officer: Accountant

Completion Date: 30.11.2019

Audit Committee Meeting Minutes
9 October 2019



7.2.2. Payroll Exceptions
Finding Rating: Moderate

During our payroll testing, we noted the following exceptions pertaining to our audit sample:

- The Synergy Variance Reports 'Compare Gross Pays to Last Time Paid' for 21 August 2018, 11 December 2018 and 5 March 2019 were annotated, however there was no sign of to evidence review;
- The 'Payslip Reports' for 21 August 2018, 11 December 2018 and 5 March indicated evidence of checks being completed, however the reviewer had not signed the reports;
- The BankWest 'Payroll File Upload' listing payments made to each employee had not been retained for 21 August 2018, 11 December 2018 and 5 March 2019;
- There was no termination checklist completed for employee 2453; and
- We were unable to verify deductions from the following employee wages:
 - Employee number 2089 – social club deduction;
 - Employee number 1176 – rates deduction;
 - Employee number 2227 – WA super salary sacrifice deduction; and
 - Employee number 2003 – ASU and social club deduction.

Implications / Risks

- The absence of review and approval of payroll reports could result in invalid transactions and incorrect amounts being paid to employees.
- There is an increased risk of loss to the Shire if all termination procedures are not carried out prior to an employee ceasing.
- The Shire is deducting amounts from the employee wages that has not been appropriately authorised by the employee.

Recommendation

We recommend the following:

- All payroll reports be independently reviewed and evidence of this review is documented in the form of a physical sign-off;
- Termination checklists be completed for all terminated employees, reviewed and approved by the management; and
- All deductions from employee wages are supported by an authorised deduction form.

Management Comment

- All payroll reports are now signed. The checks and balances are all done. However previously not signed.
- All terminations are signed as checked by the Accountant. Termination Form to be developed
- The process for deductions has been changed to file all amendments in personnel files as per the recommendation.

Responsible Officer: Accountant

Completion Date: 26.06.2019



7.2.3. Excessive Leave Balances

Finding Rating: Minor

Review of annual leave accrual as at 30 April 2019 indicated instances where seven employees had annual leave accrued balances in excess of 300 hours each.

Implication

The cost to Shire of Northam is greater if annual leave is not paid out on a regular basis due to:

- The cumulative effect of salary increases over a period of time;
- Recreational leave enhances employee performance; and
- It is a fundamental principle of good internal control that all employees take regular leave.

Recommendation

We recommend employees take regular leave through ongoing management of leave scheduling and leave liabilities.

Management Comment

Noted, leave balances will continue to be monitored

Responsible Officer: EMCS

Completion Date: 26.06.2019

UNCONFIRMED



8. Preparation of budgets, budget reviews, accounts and reports required by the Act or the Regulations

8.1. Scope and approach

- Reviewed policy and procedure manual;
- Reviewed the procedures for preparation of the monthly financial statements, annual financial statements and annual Budget, including assessment of accounting policy, notes and applicable reporting requirements and efficiency of the process;
- Reviewed monthly financial statements ensuring presented to Council within two months and information contained within monthly financial statements in accordance with Regulation 34 of Local Government (Financial Management) Regulations 1996;
- Reviewed the mid-year budget review to ensure compliance with Regulation 33A of the Local Government (Financial Management) Regulations 1996 and assessment of budgetary expenditure controls in place;
- Ensured prior year audit report and management letter have been presented to audit committee and Council; and
- Reviewed compliance with Part 6 of the Local Government Act 1995 and Local Government (Financial Management) Regulations 1996.

8.2. Detailed findings and recommendations

8.2.1 Risk Management Policy

Finding Rating: Low

We noted the Shire's Risk Management Policy was due for review in 2017 and still references the former AS/NZS 31000:2009 standard as opposed to the updated version AS/ISO 31000:2018.

Implications / Risks

Risk that the Shire's Risk Management Policy is out of date.

Recommendation

We recommend that Shire review and update the Risk Management Policy accordingly.

Management Comment

Policy will be updated

Responsible Officer: CEO

Completion Date: 30.11.2019



9. Guidance on Risk Assessment

Risk is uncertainty about an outcome. It is the threat that an event, action or non-action could affect an organisation's ability to achieve its business objectives and execute its strategies successfully. Risk is an inherent component of all service activities and includes positive as well as negative impacts. As a result not pursuing an opportunity can also be risky. Risk types take many forms – business, economic, regulatory, investment, market, and social, just to name a few.

Risk management involves the identification, assessment, treatment and ongoing monitoring of the risks and controls impacting the organisation. The purpose of risk management is not to avoid or eliminate all risks. It is about making informed decisions regarding risks and having processes in place to effectively manage and respond to risks in pursuit of an organisation's objectives by maximising opportunities and minimising adverse effects.

The risk guidelines stated within Risk Management – Guidelines Standard AS ISO 31000-2018.

Our guidance to risk classification in completing our review is as follows:

Measure of Likelihood of Risk

Likelihood is the chance that the event may occur given knowledge of the organisation and its environment. The following table provides broad descriptions to support the likelihood rating:

Rating	Description	Frequency	Probability
Almost Certain	The event is expected to occur in most circumstances.	More than once per year.	>90% chance of occurring.
Likely	The event will probably occur in most circumstances.	At least once per year.	60% - 90% chance of occurring.
Possible	The event should occur at some time.	At least once in 3 years.	40% - 60% chance of occurring.
Unlikely	The event should occur at some time.	At least once in 10 years.	10% - 40% chance of occurring.
Rare	The event may only occur in exceptional circumstances.	Less than once in 15 years.	<10% chance of occurring.

*Above Extracted from the Shire's Risk Management Framework.

Measure of Consequence of Risk

Consequence is the severity of the impact that would result if the event were to occur. The following table provides broad descriptions to support the consequence rating:

Audit Committee Meeting Minutes
9 October 2019



Rating (Level)	Health	Financial Impact	Service Interruptions	Compliance	Reputational	Property	Environment
Insignificant (1)	Negligible injuries	Less than \$2,000	No material service interruption	No noticeable regulatory or statutory impact	Unsubstantiated low impact, low profile or 'no news' item	Inconsequential or no damage	Contained, reversible impact managed by on site response
Minor (2)	First aid injuries	\$2,001 - \$20,000	Short term temporary interruption – backlog cleared < 1 day	Some temporary non-compliances	Substantiated, low impact, local news item	Localised damage rectified by routine internal procedures	Contained, reversible impact managed by internal response
Moderate (3)	Medical type injuries	\$20,001 - \$200,000	Medium term temporary interruption backlog cleared by additional resources <1 week	Short term non-compliance but with significant regulatory requirements imposed	Substantiated public embarrassment, moderate impact, moderate news profile	Localised damage requiring external resources to rectify	Contained, reversible impact managed by external agencies
Major (4)	Lost time injury	\$200,001 - \$2,000,000	Prolonged interruption of services – additional resources, performance affected < 1 month	Non-compliance results in termination of services or imposed penalties	Substantiated public embarrassment, high impact, high news profile, third party actions	Significant damage requiring internal & external resources to rectify	Uncontained, reversible impact managed by a coordinated response from external agencies
Catastrophic (5)	Fatality, permanent disability	More than \$2,000,000	Indeterminate prolonged interruption of services – non-performance > 1 month	Non-compliance results in litigation, criminal charges or significant damages or penalties	Substantiated public embarrassment, very high multiple impacts, high widespread multiple news profile, third party actions	Extensive damage requiring prolonged period of restitution Complete loss of plant, equipment & building	Uncontained, irreversible impact

*Above Extracted from the Shire's Risk Management Framework.



Risk Analysis Matrix – Level of Risk

Finding Rating for each audit issue was based on the following table:

		CONSEQUENCE				
		Insignificant	Minor	Moderate	Major	Catastrophic
LIKELIHOOD	Almost Certain	Moderate	High	High	Extreme	Extreme
	Likely	Low	Moderate	High	High	Extreme
	Possible	Low	Moderate	Moderate	High	High
	Unlikely	Low	Low	Moderate	Moderate	High
	Rate	Low	Low	Low	Low	Moderate

*Above Extracted from the Shire's Risk Management Framework.

Finding / Risk Acceptance Rating

The table below sets out the definition of the Shire's finding / risk acceptance rating:

Finding / Risk Rank	Definition
Low	<ul style="list-style-type: none"> Attention required in medium term, preferably within 12 months. Isolated cases of procedural non-compliance. Small transactional errors with nil to small financial loss or exposure to the Shire. Isolated administrative matters.
Moderate	<ul style="list-style-type: none"> Attention required in medium term, preferably within 6 months. Absence or breakdowns in controls or procedures that lead to moderate exposures to the Shire. Isolated breaches of legal requirements and/or regulations with no further action likely to be taken by a regulator. Moderate individual transactional errors or several smaller transactional errors. Administrative matters, which due to their frequency may indicate procedural or training problems.
High	<ul style="list-style-type: none"> Attention required in short term, preferably within 3 months. Absence or breakdowns in controls or procedures that lead to high exposures. A breach of legal requirements and/or regulations resulting in material compensation and/or financial payouts, however no further action is likely to be taken by a regulator. Large individual transactional errors or a larger number of smaller transactional errors. Administrative matters, which due to their frequency may indicate procedural or training problems. Issues arising from inadequate training.
Extreme	<ul style="list-style-type: none"> Urgent and immediate action required. Cases of actual or potential fraud. Absence or breakdowns in critical controls or procedures that lead to very significant exposures to the Shire (i.e. financial loss impacting capital or significant disruption to business services, loss of life, severe reputation risk). Serious breach of legal requirements and/or regulations resulting in material compensation and/or financial payouts and action likely to be undertaken by regulators. Multiple large transactional errors that could lead to serious legal impact and/or severe adverse effect on the Shire's reputation. Issues arising from no or severely inadequate training.

Audit Committee Meeting Minutes
9 October 2019



5.12 INTERIM AUDIT REPORT

Address:	N/A
Owner:	N/A
Applicant:	Shire of Northam
File Reference:	1.6.1.6
Reporting Officer:	Colin Young Executive Manager Corporate Services
Responsible Officer:	Colin Young Executive Manager Corporate Services
Officer Declaration of Interest:	Nil
Voting Requirement:	Simple Majority
Press release to be issued:	No

BRIEF

For the Audit Committee to receive an update on the Interim Audit that was conducted by the Shire's auditor, Moore Stephen's on the 29 April 2019.

ATTACHMENTS

Attachment 1: Interim Audit Report.

A. BACKGROUND / DETAILS

The Interim Audit was carried out on the 29 April 2019, Moore Stephen's conducted the interim audit on behalf of the Office of the Auditor General. It concentrated largely on the overall control environment, but not for the purpose of expressing an opinion on the effectiveness of internal, and to obtain an understanding of the key business processes, risks and internal controls relevant to the audit of the Annual Financial Report.

B. CONSIDERATIONS

B.1 Strategic Community / Corporate Business Plan

Theme Area 6: Governance & Leadership.

Outcome 6.3: The Shire of Northam council is a sustainable, responsive, innovative and transparent organisation.

Objective:

- Ensure robust financial management.
- Implement systems and processes which deliver outcomes for our community.
- Maintain a high standard of corporate governance.

B.2 Financial / Resource Implications

Nil

B.3 Legislative Compliance

Local Government Act (1995) Section 7.12A.

B.4 Policy Implications

N/A

B.5 Stakeholder Engagement / Consultation

Nil

B.6 Risk Implications

Risk Category	Description	Rating (consequence x likelihood)	Mitigation Action
Financial	Possible misstatement in the financial Statements	Low (2)	Ensure reporting is accurate and complete
Health & Safety	N/A	N/A	N/A
Reputation	Low impact news item or potential dispute with employee	Low (2)	Ensure reporting is accurate and complete. Ensure notification of annual increase is given to employees
Service Interruption	N/A	N/A	N/A
Compliance	If report not done Council would not be aware.	Low (2)	Ensure the Act is adhered to
Property	N/A	N/A	N/A
Environment	N/A	N/A	N/A

C. OFFICER'S COMMENT

The Auditor has raised three issues as presented below, two items are considered to have moderate implications, one item was considered minor in nature. These were received on 30 May 2019

1. IT Disaster Recovery Plan.

It was identified that the Shire does not have an IT disaster recovery plan. It highlighted an increased risk the Shire will not possess the required information to enable effective restoration of key IT systems following a major incident or disruption.

Audit Committee Meeting Minutes
9 October 2019



Management Comment: Back-up procedures and testing of data recovery has been carried out to the satisfaction of Staff, a formal disaster recovery plan will be documented

2. Fixed Assets below \$5,000

From 1 July 2018, Regulation 17A (5) of the Local Government (Financial Management) Regulations 1996 requires assets with a fair value at the date of acquisition under \$5,000 to be excluded from the assets of the Local Government entity.

It was noted that the assessment had not been conducted to remove assets acquired for a value of less than \$5,000.

Management Comment: A review will be carried out to assert any assets that had an original purchase price of less than \$5,000, these will be written off from the asset register

3. Employment Pay Rate Letters

We noted 10 instances where employees had received an increase in pay or pay level, with no correspondence to the employee confirming the change evidenced in the employee's personnel file.

Management Comment: notification will be given to employees annually on the first pay period of the annual CPI based increase

RECOMMENDATION / COMMITTEE DECISION

Minute No: AU.134

Moved: Cr Antonio

Seconded: Cr Mencshelyi

That Council receive the 2018/19 Interim Audit finding.

CARRIED 2/0

The Executive Manager Corporate Services provided an overview of the findings.



Our Ref: 8361

Mr Jason Whiteaker
Chief Executive Officer
Shire of Northam
PO Box 613
NORTHAM WA 6401



Mail to: Perth BC
PO Box 8499
PERTH WA 6849
Tel: (08) 6557 7500
Fax: (08) 6557 7600
Email: info@audit.wa.gov.au

Dear Sir

**ANNUAL FINANCIAL REPORT
INTERIM AUDIT RESULTS FOR THE YEAR ENDING 30 JUNE 2019**

We have completed the interim audit for the year ending 30 June 2019. We performed this phase of the audit in accordance with our audit plan. The focus of our interim audit was to evaluate your overall control environment, but not for the purpose of expressing an opinion on the effectiveness of internal control, and to obtain an understanding of the key business processes, risks and internal controls relevant to our audit of the annual financial report.

Management Control Issues

I would like to draw your attention to the attached listing of deficiencies in internal control and other matters that were identified during the course of the interim audit. These matters have been discussed with management and their comments have been included on the attachment. The matters reported are limited to those deficiencies that were identified during the interim audit that we have concluded are of sufficient importance to merit being reported to management. Some of the matters may be included in our auditor's report in accordance with section 7.9(2) of the *Local Government Act 1995* or regulation 10(3)(a) and (b) of the *Local Government (Audit) Regulations 1996*. If so, we will inform you before we finalise the report.

This letter has been provided for the purposes of your local government and may not be suitable for other purposes.

We have forwarded a copy of this letter to the President. A copy will also be forwarded to the Minister for Local Government when we forward our auditor's report on the annual financial report to the Minister on completion of the audit.

Feel free to contact me on 6557 7601 if you would like to discuss these matters further.

Yours faithfully



ANNE LEI
ASSISTANT DIRECTOR
FINANCIAL AUDIT
23 May 2019

Attach

ATTACHMENT

SHIRE OF NORTHAM
PERIOD OF AUDIT: YEAR ENDED 30 JUNE 2019
FINDINGS IDENTIFIED DURING THE INTERIM AUDIT

INDEX OF FINDINGS	RATING		
	Significant	Moderate	Minor
1. IT Disaster Recovery Plan		✓	
2. Fixed Assets Below \$5,000		✓	
3. Employment Pay Rate Letters			✓

KEY TO RATINGS

The Ratings in this management letter are based on the audit team's assessment of risks and concerns with respect to the probability and/or consequence of adverse outcomes if action is not taken. We give consideration to these potential adverse outcomes in the context of both quantitative impact (for example financial loss) and qualitative impact (for example inefficiency, non-compliance, poor service to the public or loss of public confidence).

- Significant** - Those findings where there is potentially a significant risk to the entity should the finding not be addressed by the entity promptly.
- Moderate** - Those findings which are of sufficient concern to warrant action being taken by the entity as soon as practicable.
- Minor** - Those findings that are not of primary concern but still warrant action being taken.

ATTACHMENT

SHIRE OF NORTHAM
PERIOD OF AUDIT: YEAR ENDED 30 JUNE 2019
FINDINGS IDENTIFIED DURING THE INTERIM AUDIT

1. IT Disaster Recovery Plan

Finding

We noted that the Shire does not have an IT disaster recovery plan.

Rating: Moderate

Implication

Without an IT disaster recovery plan, there is an increased risk that the Shire will not possess the required information to enable the effective restoration of key IT systems following a major incident or disruption. This may impact business operations and the delivery of key services.

Recommendation

Management should ensure that an adequate disaster recovery plan is developed and endorsed.

Management Comment

Back-up procedures and testing of data recovery has been carried out to the satisfaction of Staff, a formal disaster recovery plan will be documented.

Responsible Person: Executive Manager Corporate Services

Completion Date: November 2019

ATTACHMENT

SHIRE OF NORTHAM
PERIOD OF AUDIT: YEAR ENDED 30 JUNE 2019
FINDINGS IDENTIFIED DURING THE INTERIM AUDIT

2. Fixed Assets Below \$5,000

Finding

From 1 July 2018, Regulation 17A(5) of the Local Government (Financial Management) Regulations 1996 requires assets with a fair value at the date of acquisition under \$5,000 to be excluded from the assets of a local government entity.

We note that an assessment has not been conducted to remove assets acquired for a value less than \$5,000. No new additions for assets costing less than \$5,000 were noted during the year.

Rating: Moderate

Implication

Non-compliance with the Local Government (Financial Management Regulation 17A(5)) resulting in a possible misstatement in the financial statements.

Recommendation

Management should review the fixed asset register and ensure any assets acquired with a fair value under \$5,000 are excluded from the register.

Management Comment

A review will be carried to assert any assets that had an original purchase price of less than \$5,000, these will be written off from the asset register.

Responsible Person: Accountant
Completion Date: 30 June 2019

ATTACHMENT

SHIRE OF NORTHAM
PERIOD OF AUDIT: YEAR ENDED 30 JUNE 2019
FINDINGS IDENTIFIED DURING THE INTERIM AUDIT

3. Employment Pay Rate Letters

Finding

We noted 10 instances where employees had received an increase in pay or pay level, with no correspondence to the employee confirming the change evidenced in the employee's personnel file.

Rating: Minor

Implication

The absence evidence of agreed pay rates may make it difficult to resolve any potential pay disputes with employees.

Recommendation

Management should ensure evidence of agreed pay rates for each employee are maintained.

Management Comment

Notification will be given to employees annually on the first pay period of the annual CPI based increase.

Responsible Person: Accountant
Completion Date: August 2019

Audit Committee Meeting Minutes
9 October 2019



6. URGENT BUSINESS APPROVED BY DECISION

Nil.

7. DATE OF NEXT MEETING

The next Audit Committee meeting is proposed to be held in November/December 2019, date to be confirmed.

8. DECLARATION OF CLOSURE

There being no further business the Presiding Member, Cr CR Antonio declared the meeting closed at 4:55pm.

"I certify that the Minutes of the Ordinary Meeting of Council held on Wednesday, 9 October 2019 have been confirmed as a true and correct record."

_____ President

_____ Date

12. OFFICER REPORTS

12.1 CEO'S Office

12.1.1 November 2019 Council Forum and Ordinary Council Meeting

Address:	N/A
Owner:	N/A
Applicant:	N/A
File Reference:	2.1.3.1
Reporting Officer:	Alysha McCall, Executive Assistant – CEO
Responsible Officer:	Clinton Kleynhans, A/Chief Executive Officer
Officer Declaration of Interest:	Nil
Voting Requirement:	Simple Majority
Press release to be issued:	No

BRIEF

For Council to consider changing the meeting location to the Council Chambers for the November 2019 Forum and Ordinary Council meeting which is scheduled on 13th and 20th November 2019 in Grass Valley. This change is recommended as a result of the November meeting being the first meeting after the 2019 Local Government Elections, with a large number of agenda items proposed. In addition, harvest will be occurring at this time and it is understood that this may impact community input at the meeting.

ATTACHMENTS

Nil.

A. BACKGROUND / DETAILS

At the Ordinary Council meeting scheduled on 21st November 2018, Council set the meeting dates and locations for the 2019 Council meetings. At the Ordinary Council meeting held on 15 August 2018, Council resolved the following:

MOTION / COUNCIL DECISION

Minute No: C.3445

Moved: Cr Williams

Seconded: Cr Mencshelyi

That Council discontinue holding community meetings at Bakers Hill, Grass Valley and Wundowie subject to a Council Forum and Ordinary Council meeting being scheduled at these locations in 2019, with available Councillors and staff including the Chief Executive Officer and Executive Managers attending the location one (1) hour prior to the Forum meeting commencing to allow for consultation with local residents.

CARRIED 8/0

Council held its February 2019 meeting in Bakers Hill and May 2019 meeting in Wundowie. This change (if endorsed) will impact the requirements of the above resolution of Council, however as a result it is recommended that two meetings be held in Grass Valley during 2020 and one meeting in both Bakers Hill and Wundowie.

B. CONSIDERATIONS

B.1 Strategic Community / Corporate Business Plan

Theme Area 6: Governance and Leadership.

Outcome 6.3: The Shire of Northam council is a sustainable, responsive, innovative and transparent organisation.

Objective: Encourage active community participation in our local government.

B.2 Financial / Resource Implications

It is anticipated that advertising costs for the change of the meeting location will be approximately \$300.

B.3 Legislative Compliance

Local Government Act 1995 – s5.4;

Local Government (Administration) Regulations, Reg 12.

B.4 Policy Implications

Nil.

B.5 Stakeholder Engagement / Consultation

Officers consulted with Elected Members by email on 26th September 2019 advising them of the proposal and sought feedback. No concerns were raised in relation to proposed change. In addition, Officers have liaised with the Grass Valley Progress Association who also have no concerns changing the date for the Council meeting being held in Grass Valley. It was noted that the holiday season could impact the number of community attendees and therefore it is recommended that the first Grass Valley Council meeting be rescheduled to February 2020 with another Council meeting being held later in the year.

B.6 Risk Implications

Risk Category	Description	Rating (consequence x likelihood)	Mitigation Action
Financial	Additional advertising costs for the change of the meeting location.	Moderate (5)	Advertising is required to ensure compliance with the Local Government Act 1995 and subsidiary legislation.
Health & Safety	N/A		
Reputation	A meeting being held in Grass Valley during 2019 does not enable the community to participate in the local governments processes.	Low (2)	Due to not holding a meeting in Grass Valley in 2019, it is recommended that two meetings be held within this community during 2020 to ensure that the opportunity for participation is equal within the Shire's communities.
Service Interruption	N/A		
Compliance	N/A		
Property	N/A		
Environment	N/A		

C. OFFICER'S COMMENT

Officers are recommending that the November Forum and Ordinary Council meeting be changed due to the reasons previously mentioned in this report. Due to this change, Officers are recommending that two Forum and Ordinary Council meetings be scheduled in Grass Valley during 2020 with the first occurring in February and the second later within the year which does not conflict with harvest. This recommendation will also form part of a subsequent report to Council to endorse the 2020 meeting dates and locations.

RECOMMENDATION / COUNCIL DECISION

Minute No: C.3780

Moved: Cr Ryan

Seconded: Cr Mencshelyi

That Council:

- 1. Change the meeting location for the Forum scheduled on 13th November 2019 and the Ordinary Council meeting scheduled on 20th November 2019 from the Grass Valley Hall to the Shire of Northam Council Chambers;**
- 2. Request the Chief Executive Officer to advertise the change of meeting location in accordance with the Local Government (Administration) Regulations 1996, Regulation 12 (2); and**
- 3. Reschedule the Grass Valley Forum and Ordinary Council Meeting to February 2020, with an additional meeting being held during 2020 which is to be presented as part of a subsequent report to endorse the 2020 meeting dates and locations.**

CARRIED 6/0

12.2 ENGINEERING SERVICES

12.2.1 Vehicle & Plant Management Policy

Address:	N/A
Owner:	N/A
Applicant:	N/A
File Reference:	2.3.1.2
Reporting Officer:	Clinton Kleynhans, Executive Manager Engineering Services
Responsible Officer:	Clinton Kleynhans, Executive Manager Engineering Services
Officer Declaration of Interest:	Nil
Voting Requirement:	Simple Majority
Press release to be issued:	No

BRIEF

For Council to review and endorse the proposed Vehicle Management Policy as attached.

ATTACHMENTS

Attachment 1: W5.8 Vehicle Management Policy.
Attachment 2: SoN Fleet Review March 2019.

A. BACKGROUND / DETAILS

Up until the 2019/ 20 budget development, the existing replacement strategy for plant and vehicles had replacement frequency as follows for various types of vehicles:

Light vehicles: Every 3 years or 60,000km (2017 onward)
Heavy Plant: Every 7-10 years or 7000-16000 hrs
Small Plant: Every 10 years

Staff were of the opinion that the frequency of replacement could be prolonged which would present a cost saving for the Shire, whilst not affecting service levels.

In March 2019 the Shire engaged the services of GHD to review the Shire's fleet of plant and vehicles, current strategies, potential improvements and

recommendations to implement the most cost effective replacement strategy which allows delivery of acceptable service levels.

The proposed Vehicle Management Policy has been developed based on the primary reconditions of that review.

B. CONSIDERATIONS

B.1 Strategic Community / Corporate Business Plan

Theme Area 5: Infrastructure and Service Delivery

Outcome 5.3: To have safe, well-maintained community infrastructure and services to a standard expected of a Regional Centre.

Objectives:

- Deliver infrastructure projects effectively, on budget and schedule, aligned with local community plans and infrastructure projects.
- Build on community service delivery models to ensure services are continuously improved and modernised to meet community needs.
- Maintain an efficient and safe regional road network.

B.2 Financial / Resource Implications

By prolonging the replacement frequency of light vehicles from 2 years to 4-5 years there is an estimated saving in the order of \$550,000 over the term of a 10 year replacement program.

B.3 Legislative Compliance

Nil.

B.4 Policy Implications

Nil.

B.5 Stakeholder Engagement / Consultation

During the Fleet Management Review process consultation was performed with Plant Operators, Crew and the Management Team.

B.6 Risk Implications

Risk Category	Description	Rating (consequence x likelihood)	Mitigation Action
Financial	Having a replacement strategy that is too frequent resulting in preventable cost to Council	Medium (3)	Have a Policy and Strategy in place to ensure plant and vehicles are replaced at optimum times.

Health & Safety	N/A	N/A	N/A
Reputation	N/A	N/A	N/A
Service Interruption	Not having an appropriate replacement strategy may cause breaks in service delivery	High (4)	Ensure replacement and maintenance programs are in place to avoid any service disruptions
Compliance	N/A	N/A	N/A
Property	Not maintaining vehicles and plant appropriately may result in avoidable damage and reduced useful life.	Medium (3)	Ensure maintenance programs are in place to avoid unnecessary damaged cause to plant and equipment.
Environment	N/A	N/A	N/A

C. OFFICER'S COMMENT

The outcome of the review identified a number of areas where the Shire could change their current practice to reduce costs, improve efficiencies and consider outsourcing of some services due to low demand.

In summary these were:

- Review low usage vehicles with consideration to reducing the number of these and either contract out that service, periodically hiring the required vehicle/ plant and utilise unassigned vehicles as pool vehicles;
- Prolong the replacement frequency of light vehicles from 3 years to 4-5 years, taking advantage of extended warranties being offered by vehicle manufactures’;
- Maintain the current replacement strategy for plant, using condition and warranties as the primary trigger for consideration of replacement.

It should be noted, whilst the assessment was performed based on the usage of individual vehicles and plant usage, some recommendations may not be practical for various reasons. These have not been incorporated into the proposed Vehicle Management Policy.

The proposed Policy has been developed based on recommendations which will present Council cost savings in future replacement strategies.

RECOMMENDATION / COUNCIL DECISION

Minute No: C.3781

Moved: Cr Della

Seconded: Cr Little

That Council adopt Draft Policy W5.8 Vehicle and Plant Management Policy as presented.

CARRIED 6/0

Attachment 1

W 5.8 Vehicle and Plant Management Policy

<i>Responsible Department</i>	Engineering Services
<i>Resolution Number</i>	
<i>Resolution Date</i>	
<i>Next Scheduled Review</i>	2021
<i>Related Shire Documents</i>	Asset Management Policy Employee Code of Conduct Workplace Health & Safety Policy
<i>Related Legislation</i>	Local Government Act 1995

OBJECTIVE

- To clearly define the appropriate use of Shire owned vehicles for operational purposes;
- To ensure Shire owned plant and vehicles are purchased and replaced with cost effectiveness;
- To provide clear guidelines to employees for private usage of Shire owned vehicles;
- Maximise vehicle availability for business use;
- Minimise Fringe Benefit Tax (FBT) liabilities;
- Provide an attractive employment package for staff.

SCOPE

This Policy applies to all Shire of Northam employees which use Shire owned plant and vehicles for operational purposes and/ or agreed private use. The Policy is also extended to persons which have agreed operational use that are not direct employees of the Shire.

POLICY

Executive Managers shall be responsible to ensure this Policy is complied with within their department. The Fleet Manager will be responsible for coordinating the Policy in collaboration with the Chief Executive Officer (CEO).

Category 1	Vehicle	Conditions of Use
Community Pool Vehicle /	Type: Bus or vehicle specific to operational need.	<p>Training / Conference Attendance:</p> <ul style="list-style-type: none"> • Request for use to be made to Departmental Executive Manager following approval of training request. <p>Operational Purposes:</p> <ul style="list-style-type: none"> • Request for use to be made to any Officer with an

		assigned vehicle.
<p>Category 2</p> <p>Officers</p>	<p>Vehicle</p> <p>Type: Base model Small Sedan, SUV or vehicle to meet operational needs</p> <p>Colour: White</p>	<p>Conditions of Use</p> <ul style="list-style-type: none"> • Commuter Use; • Approved travel to and from the employee's place of employment and home. • Travel other than commuter use requires Executive Manager approval and operating costs to be inherited by employee. • Commuter Use excludes the following: • Transportation of members of the public other than for official purposes; • Visits to private or other non-work related locations, unless on the direct route.
<p>Category 3</p> <p>Officers & Supervisors</p>	<p>Vehicle</p> <p>Type: Base model Small Sedan, SUV or vehicle to meet operational needs</p> <p>Colour: White</p>	<p>Conditions of Use</p> <ul style="list-style-type: none"> • Restricted Private Use • Approved travel within the Shire of Northam. • Travel outside of the Shire of Northam requires Executive Manager approval and operating costs to be inherited by employee.
<p>Category 4</p> <p>Snr Officers & Managers</p>	<p>Vehicle</p> <p>Type: Base model Medium Sedan, SUV or vehicle to meet operational needs</p> <p>Colour: White</p>	<p>Conditions of Use</p> <ul style="list-style-type: none"> • Restricted Private Use; • Approved travel within 200km of home address; • Travel outside of 200km radius of home address requires Executive Manager approval and operating costs to be inherited by employee.
<p>Category 5</p> <p>CEO Executive Managers</p>	<p>Vehicle</p> <p>Type: Large Sedan, 4x4, SUV or Station Wagon.</p> <p>Colour: Any non-vibrant</p>	<p>Conditions of Use</p> <ul style="list-style-type: none"> • Unrestricted Private Use; • Approved travel within Western Australia; • Travel outside of Western Australia subject CEO Approval;

GENERAL VEHICLE USEAGE

With the exception of vehicles allocated to designated special purpose positions, all Shire vehicles are to be made available for usage as pool vehicles during core business hours. Vehicles to be made available outside of these hours (excluding private use categories) shall be at the discretion of the Departmental Executive Manager.

PERIODS OF LEAVE

Category 1 to 4 employees whom are absent from the workplace for a period of more than two (2) consecutive weeks (paid or unpaid leave), will require approval to retain use of the vehicle from the Departmental Executive Manager.

Category 5 employees shall retain their vehicles during periods of leave, with the use of fuel cards to be in accordance with contract agreements.

FRINGE BENEFIT TAX REPORTIING

All Fringe Benefits Tax (FBT) reporting requirements are to be completed and submitted to the Accountant by the due date. These include:

- Log books of vehicle use are to be completed when requested;
- Annual returns giving details of any employee using the vehicle;
- The start and finish dates of each period of use, and;
- Details of the vehicle use when allocated to another person.

Employee's allocated vehicles for commuting or limited private use are required to notify the Fleet Manager of any changes to the allocation of the vehicle (eg. during leave or staff rotation etc). Failure to do so will result in the assumption the vehicle is still under the employees control and associated fringe benefits will be attributed to the employee.

CARE OF VEHICLE

Employees who have been assigned a vehicle shall be responsible for the proper care of the vehicle including safe keeping, regular cleaning – both inside and out and ensuring that normal running items such as fuel, oil, battery, radiator and tyre pressure are checked at regular intervals.

Employees shall be responsible for ensuring an allocated vehicle is used appropriately at all times. Employees shall be responsible for paying for any damage that occurs when a vehicle has been deemed to have been used inappropriately.

Reconditioning costs at change over may be recovered from staff if the vehicle is excessively damaged through negligence. The Fleet Manager shall report excessive reconditioning costs to the relevant Executive Manager. The CEO shall decide if excessive reconditioning costs are required to be paid by the Officer.

SELECTION OF VEHICLE TYPE

Category 1 to 4 employees will be allocated a base model vehicle or a vehicle that is specific to operational needs.

Category 5 employees will be allocated a vehicle appropriate to the position and in accordance with their contract conditions.

All vehicles are to be purchased from local dealerships in accordance with the purchasing policy unless otherwise agreed by the CEO.

SAFETY RATINGS

Where practicable, vehicles purchased will have a 5 Star ANCAP (Australasian New Car Assessment Program) rating. Operational vehicles with a lower ANCAP rating may be purchased subject to operational needs and at the discretion of the Fleet Manager.

LEGAL REQUIREMENTS

It is the employee's responsibility to maintain the relevant class driver's license to operate a Shire vehicle. Employees who are holders of probationary, or extraordinary licenses must display the appropriate plates in a prominent position.

The driver will be responsible for any fine incurred in the operation of vehicles whether on Council business (when under the control of the employee) or using it for private purposes.

In the event of an accident or damage to a vehicle it is the responsibility of the employee to:

- Report as soon as practicable to the Fleet Manager, any involvement in a motor vehicle accident or upon sustaining general damage to the vehicle;
- Report any accident in a motor vehicle to the Police where required by law;
- Not accept or acknowledge any liability on behalf of Council arising from an accident;
- Complete as soon as practical after the accident, the appropriate claim form and incident report form, returning them to the relevant Officers.

Vehicle rights usage shall be revoked if the employee's motor vehicle license has lapsed or is suspended for any reason, until such time a driver's license has been reinstated.

Where the employee, or person authorised by the employee, is involved in an accident whilst on private use and subsequently convicted of an offence, Council reserves the right to recover any expenses incurred as a direct result of that accident.

OTHER DRIVERS

Category 1 to 3 employees shall not allow any non-direct employees' drive the vehicle.

Category 4 employees are permitted to have their spouse / partner drive the vehicle with them present, and in accordance with conditions of that category and state legislation if prior approval has been obtained from the Departmental Executive Manager.

Category 5 employees are permitted to have their spouse or partner drive the vehicle in accordance with conditions of that category and state legislation.

VEHICLE ROTATION & REPLACEMENT

The following replacement frequency will apply to the Shires fleet of plant and vehicles:

Passenger Vehicles:	every 4 years
Operational Vehicles:	every 5 years or end of warranty periods
Heavy Plant:	7 years or 8000-15000 hours, to be assessed annually for condition.

Vehicles may be reallocated amongst staff to prolong utilization or preserve market value to maximize financial gain when replacing vehicles.

Fleet life cycle costs vary regularly due to a variety of factors including fuel costs, maintenance costs, used fleet prices and market and industry trends. The Shire of Northam will review these costs, and replacement periods, on a regular basis to ensure the most cost effective outcome at all times.

VEHICLE USAGE BY NON-EMPLOYEE'S

Non-employees who have a vehicle assigned for operation purposes are required to enter into a written agreement clearly defining the terms and conditions of the usage.

DEFINITIONS

Fleet Manager: The Executive Manager which has the fleet management service area assigned to them under the Corporate Plan.

Non- Employee: Is a person (excluding spouse or family member) which has an operational need to drive the vehicle, Such as Bush fire brigade member.

Pool Vehicle: Is a vehicle which is to be made available for use during business hours for other employees to use for operational purposes. This may include assigned and/ or unassigned vehicles.

Attachment 2



Shire of Northam Fleet Asset Review

Shire of Northam

26th March 2019





Contents

- 1. Introduction 1
- 2. Current State..... 1
 - 2.1 Passenger 1
 - 2.1.1 Areas of Verification..... 2
 - 2.2 Operations 2
 - 2.2.1 Additional Requirements..... 3
 - 2.2.2 Areas of Verification..... 3
 - 2.3 Parks and Gardens 3
 - 2.3.1 Additional Requirements..... 3
 - 2.3.2 Areas of Verification..... 4
 - 2.4 Procurement..... 4
- 3. Analysis 5
 - 3.1 Decision factors 5
 - 3.2 Passenger 5
 - 3.3 Operations Equipment..... 7
 - 3.3.1 Replacement timing..... 7
 - 3.3.2 Financial implications of leasing vs owning vs hiring..... 8
 - 3.4 Decision Matrix..... 9
 - 3.5 Utilisation and Response Overview..... 10
 - 3.6 Procurement Plan Impact..... 11
- 4. Recommendations and Conclusions 16
 - 4.1 Passenger Vehicles 16
 - 4.2 Operations Vehicles..... 16

Figures

- Figure 1: Graph of yearly cost of varying replacement cycles for an example \$50k Toyota Hilux..... 6
- Figure 2: Cost vs Operating Hours for a critical and non-critical equipment 8

Tables

- Table 1: Decision factors for fleet analysis 5





Table 2: Table of yearly cost of varying replacement cycles for an example \$50k Toyota Hilux..... 6
Table 3: Options analysis of leasing vs hiring vs owning..... 7
Table 4: Example costs associated with a CAT 120M Grader..... 8
Table 5: Qualitative assessment of group utilisation and importance..... 10



1. Introduction

GHD have been engaged to provide recommendations for cost effective fleet management that meets the service levels requirements of the Shire of Northam. The review includes assessing the current management of fleet and determining improvements.

The engagement process included consultation with:

- Clinton Kleynhans – Executive Manager Engineering Services
- Colin Young – Executive Manager Corporate Services
- Santo Leotta - Works Manager
- John Rutherford - Parks and Gardens Manager

GHD have reviewed the current strategies, determined potential improvements, and looked for the financial optimum solutions. There are a number of areas where further savings could be made and where deficiencies exist.

2. Current State

2.1 Passenger

The Shire owns and leases a large number of Light Vehicles. Many vehicles are provided to staff as a component of their salary package. The vehicles are kept for two to three years or 60,000 km. Some vehicles travelling to Perth and return on a daily basis have significantly higher mileage than those that stay locally. To manage the high mileage cars, internal trading is used to meet the three year and 60,000km target.

Utilisation of vehicles is monitored through a fleet tracking system that monitors and records location and status of fleet and plant. This system helps identify potential improvements in fleet management through fleet utilisation monitoring.

A portion of the light vehicle fleet are used to travel from home to the office and then sit in the car park for the majority of the day. These vehicles are under-utilised and there is potential for rationalisation of some light vehicles and wider use of pool vehicles.

Staff with an entitlement to a vehicle expressed concerned about novated leasing as an option to increase the number of pool vehicles. The novated leases could lead to issues with a lack of insurance coverage and working flexibility. For example, site inspection carried out on journeys to and from the office may not be possible if staff were using personal vehicles unless the lease conditions recognise that the vehicle is used for personal and work functions. The comprehensive insurance policy would also need to cover multiple and unspecified drivers.

2.1.1 Areas of Verification

The following area needed to be verified:

1. What are the implications of trading/selling vehicles every 60,000 kilometers and three years verses 80,000 kilometers and four years?
2. What is the financial difference between *leasing verses owning verses hiring*.

2.2 Operations

Operations vehicles covers, construction and maintenance equipment. These vehicles are generally kept for seven years or longer if the utilisation is low. Replacements are based on the Infrastructure and Public Works Engineers Association (IPWEA) Plant and Equipment Manual which recommends managing the equipment based on run hours and years of usage. The operation vehicles are generally highly utilised and important assets. Downtime of assets can be an expensive exercise for hiring replacement vehicles and/or repairing the vehicle. The current strategy is to maintain vehicles and sell then before major component failure.

The availability of quality servicing and parts is important due to the importance of the assets and the logistics of transporting the vehicle to a service center. Generally, servicing requires vehicles to be transported to Perth at \$2,000 per trip and lost time of two days plus the servicing time. Historically, local maintenance workshops are slower due to a lack of available parts and skills. The transportation cost and time in sending the vehicles to Perth is seen as beneficial because of the reliability of the service providers over the local mechanical service technicians.

As an example of the cost associated with unplanned maintenance, a grader at seven years old had a gear box issue. A replacement grader was sourced at approximately \$1,000 per day for the 10-15 week period (approximately \$100,000) while the replacement gear box was sourced and fitted. The availability of local hire equipment is also a challenge as the local provider have a small holding of construction plant and generally have to source the equipment from Perth.

The typical assets include under the operations vehicles asset types are:

- Construction: trucks, graders, steel wheel and multi compaction rollers, Loaders, backhoes, skid steer loaders and water trucks (dedicated and tank on tipper truck).
- Maintenance: grader, truck, roller, water truck and light vehicles.

Due to a current lack of equipment and skilled staff, grading of bus and truck routes is currently outsourced. Another two graders and water tanks would be required to deliver the maintenance grading on these routes. The works teams have difficulty delivering peak work load requirements with their limited resources.

Aged and surplus equipment is sold through Ross's Auctions. Assets worth more than \$50,000 cannot be traded in under Local Government Agency regulations.

Operations staff expressed concern about the current age and reliability of some of the assets. There had been more breakdowns occurring, which had affecting the deliverability of projects and maintenance programs against schedules.

2.2.1 Additional Requirements

During the consultation with the works team, the following additional requirements were discussed:

- 1 The current float is undersized for multi-roller and new grader. Floating of new grader and multi wheel roller is required because of weight and road speed of the vehicles. Hire of float trailer is considered expensive and not always available when needed.
- 2 An additional truck and trailer is needed for carting gravel
- 3 A new water truck is required to replace the second hand and unreliable vehicle
- 4 Pairing of trucks and trailers to equipment needs to be better arranged to meet total load regulation requirements
- 5 The Construction Crew need:
 - A water truck 15,000 liter (additional to existing second hand vehicle)
 - A dual cab truck
 - An upgrade of the UD Truck to a Semi with side dump tipper tray. Construction work is completed for six months of the year and then the crew flip to maintenance.
- 6 The shoulder crew need a truck for water tank (3 tonne)

2.2.2 Areas of Verification

The following questions needed to be verified:

- What is the optimum replacement timing?
- Should the Shire be leasing, hiring or owning construction plant and equipment?

2.3 Parks and Gardens

Parks and Gardens have a fleet of mowers, tractors with slashers, trucks and light vehicles. The vehicles are maintained by local service providers. Contractors are used to supplement peak workloads (such as weed spraying and slashing). The vehicles are suitable for purpose and the team has the equipment and plant suited to the work requirements. The issue for Parks and gardens is that the maintenance programs suffer because of staff limitations with equipment competencies.

The availability of spare parts has been a problem in the past, however the root cause was that the stock reordering process failed because of communication breakdown between staff.

2.3.1 Additional Requirements

The Parks and Gardens team suggested that the following additional requirements would be desirable:

- 1 A skid steer or small loader in the yard could be used to load mulch and other products. Currently the team rely on one of the construction loaders being available in yard at the time they need to load/unload materials.
- 2 A Dingo style loader would be a nice to have for narrow access and small jobs.



2.3.2 Areas of Verification

The following questions needed to be verified:

- Should the Shire be leasing, hiring, owning or contracting out parks and gardens fleet?

2.4 Procurement

The operations and maintenance crew are involved in the procurement processes to ensure the equipment purchased is fit for purpose. There have been reductions to operations and maintenance budgets and the current equipment is generally considered to be well utilised.

The procurement process includes:

- Existing plant is replaced based on age and condition, with equipment requirements agreed between procurement and operations teams.
- Procurement of new vehicles through the WALGA Panel against a specification
- New plant needs to be justified through a business case
- Finance and CEO approval is required if the purchase is included in the budget
- Council approval is required if the purchase is not in the approved budget
- The Financial Asset Register is updated with original purchase, fair value and depreciation allowance. Run hours for equipment is also included.

3. Analysis

3.1 Decision factors

The decision to own, lease, rent or contract out work is not purely a function of cost optimisation. A number of factors lead to the decision. In the analysis below, the following factors are considered in order to lead strategic decision.

Table 1: Decision factors for fleet analysis

Decision Factor	Description	Outputs
Specialised Equipment	Is the equipment unique and difficult to maintain (long lead time on parts)	Yes/No
Utilisation	How much is the equipment used throughout the year?	High >75% or >40,000kms per year Medium 75% to 25% Low <25% or <3,000kms
Skills Required	Are highly trained and trusted staff required to operate the vehicles?	High/Low
Response Urgency	Is the equipment required for emergency fault response?	Yes/No
Emergency Response	Is the equipment required for environmental hazard response?	Yes/No

Each operational group in the asset register was assessed against the decision factors as way of enabling decisions on asset ownership and procurement priorities.

3.2 Passenger

1. *What are the implications of trading/selling vehicles every 60,000 kilometers and three years verses 80,000 kilometers and four years?*

Passenger vehicles are currently replaced on a 60,000 kilometers and three yearly interval. It is estimated that a yearly cost associated with this strategy is approximately 10 percent of the vehicle renewal cost per year. In the case of the \$50,000 Toyota Hilux, that is \$5,150 per year.

When vehicle maintenance, insurance and tyres are considered, an inflection point in the yearly cost becomes apparent with a 10 year replacement cycle. This aligns with the expected bathtub asset decay curve. Where depreciation is the driver of costs at the start of life, then maintenance becomes more expensive and dominates expenditure towards the end of life.

Based on the Hilux example, moving from three yearly intervals to four yearly has the potential to save 12 percent per year. With new car warranties becoming longer, the availability of warranties from five to seven years becoming common place, it is recommended to increase the replacement intervals.

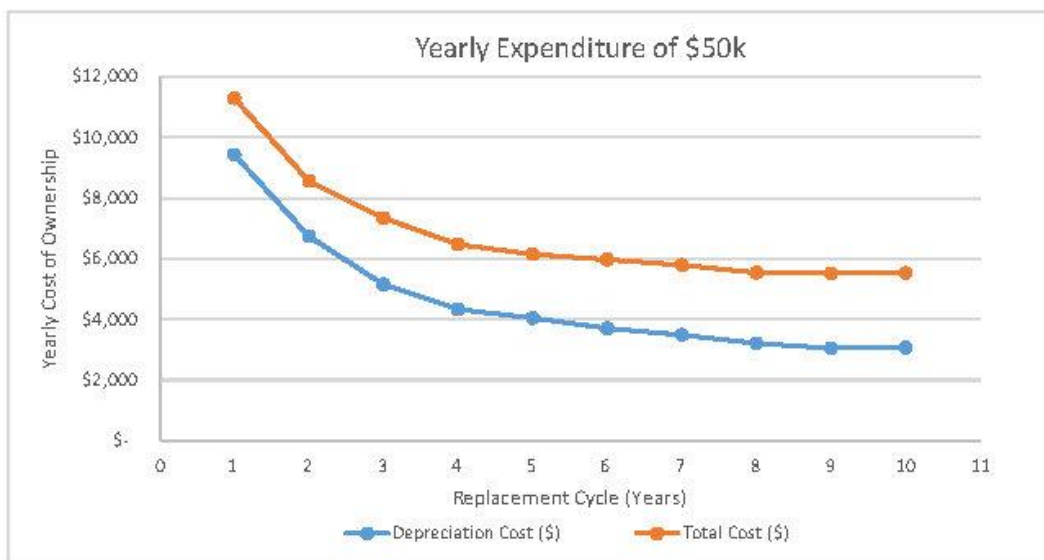

Figure 1: Graph of yearly cost of varying replacement cycles for an example \$50k Toyota Hilux

Yearly cost of ownership is presented in Figure 1. It is demonstrated that the increase in the number of years per replacement cycle of the vehicles leads to a decreasing cost of depreciation per year, but in increase in maintenance costs (dependant of capped priced servicing arrangement with dealers). Table 2 presents the underlying costs presented in Figure 1.

Table 2: Table of yearly cost of varying replacement cycles for an example \$50k Toyota Hilux

Cost Category	1 Year Cycle	2 Year Cycle	3 Year Cycle	4 Year Cycle	5 Year Cycle	6 Year Cycle	7 Year Cycle	8 Year Cycle	9 Year Cycle	10 Year Cycle
Yearly Vehicle Cost (depreciation)	9,425	6,733	5,150	4,328	4,041	3,703	3,484	3,208	3,047	3,060
Yearly Maintenance, tyres and Insurance	1,860	1,823	2,186	2,141	2,101	2,265	2,304	2,327	2,473	2,464
Total (per year cost)	11,285	8,555	7,336	6,469	6,142	5,968	5,789	5,535	5,520	5,523
Total (per day cost)	30.9	23.4	20.1	17.7	16.8	16.3	15.8	15.2	15.1	15.1



2. Financial implications of leasing vs owning vs hiring.

An example of a five year replacement cycle has been compared across leasing, hiring, and owning. The hire option is clearly the most expensive. The financial difference between leasing and owning is smaller with yearly cost implications of between 20-50 percent more for leasing vs owning.

Table 3: Options analysis of leasing vs hiring vs owning

Over 5 year period	Leasing (Wet) (\$)	Hiring (AVIS) (\$)	Owning (\$)
Toyota Hilux (per day)	20-25	120-160	17
Toyota Hilux (per month)	620-775	3,000-4,000	512
Toyota Hilux (per year)	7,440-9,300	30,000-40,000	6,142

The most cost effective method of operation is to own the vehicles outright. When the yearly vehicles utilisation drops below 10 percent (i.e. less than 36 days of the year), hiring becomes economical.

3. Pool Vehicles vs Allocated Vehicles

When considering the case of whether an employee requires access to the pool vehicles or their own allocated vehicle, utilisation of vehicles and urgency of response requirements are the two key factors in the decision. Highly utilised vehicles or vehicles that are required to respond in urgent or emergency situations should be allocated to an individual. All other vehicle requirements can be managed by a pool vehicle scenario. Table 5 presents the qualitative analysis around this issue for the various operational groups.

3.3 Operations Equipment

3.3.1 Replacement timing

Management operations equipment (Construction and Parks and Gardens) can be tackled in a similar way as the three key drivers for investment are depreciation costs, maintenance costs and the risk of overhaul. These are a similar function of the asset value across the various vehicles.

Depreciation of operations equipment is predominantly a function of run hours. The depreciation is simplistically modelled as linear over an expected 15 year life. The dominant risk factor for Operations equipment is the risk of major rebuilds outside of warranty. An example medium sized grader (CAT 120M grader) was explored for this example.

Major rebuilds are expected between 8,000-15,000 hours. Major rebuilds should be managed proactively based on the risk associated with downtime. For example, the major rebuild of the grader gearbox require a 10-15 day repair time and cost for a replacement hire vehicle are up to \$1,000 per day in rental costs (approximately \$100,000). The cost associated with an unplanned rebuild including rental is 60 percent of the vehicle new value. Without rental an estimate of 40 percent is used in the analysis.

A warranty period of 5000 hours is estimated in this example but warranties are dependent on manufacturer. Based on the available information is expected that replacement should be considered at the end of warranty periods for highly utilised and important assets. If alternative equipment is available at the depot and a rental replacement is not immediately required, there is an opportunity to extend the asset replacement cycles, however regular condition assessments should be considered to cover the risk of unplanned rebuilds.

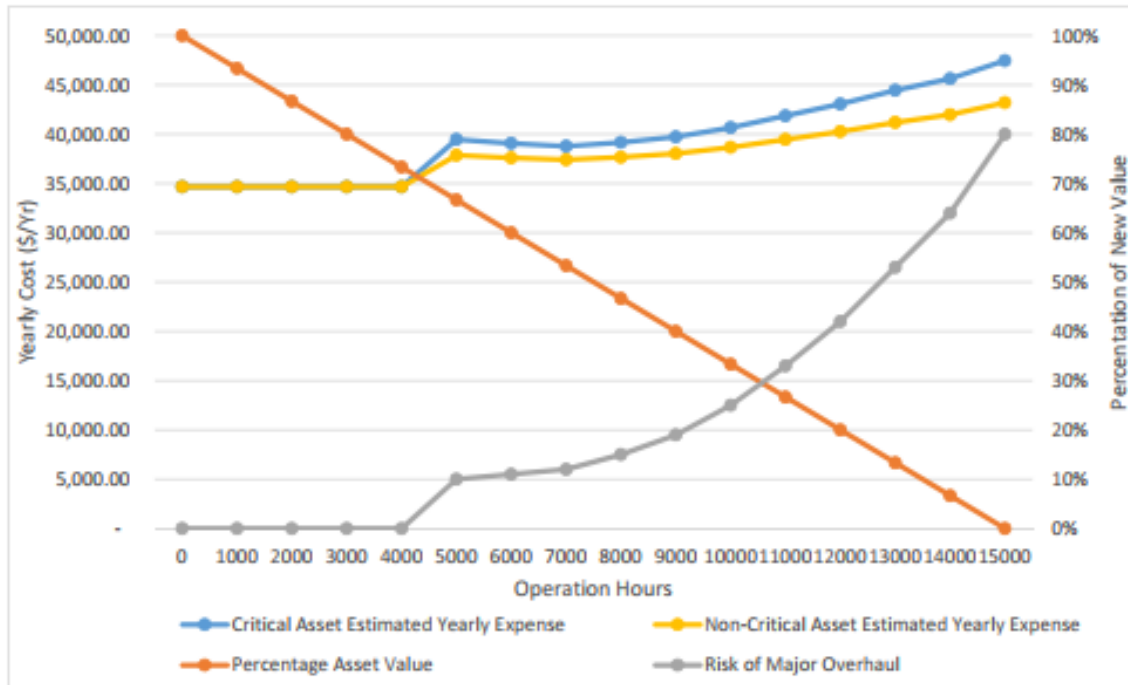

Figure 2: Cost vs Operating Hours for a critical and non-critical equipment

The driving factor for replacement on equipment is the risk of major rebuilds. These are expensive and leave the vehicle out of operation for considerable periods. Unplanned outages of critical equipment should be avoided through short replacement cycles or the use of inclusive leasing arrangements that cover unplanned outage risk.

3.3.2 Financial implications of leasing vs owning vs hiring.

Table 4: Example costs associated with a CAT 120M Grader

Over 5 year period	Leasing	Hiring (Coates Hire)	Owning
CAT 120M grader (per day)	\$150.00	\$900.00	\$104.25
CAT 120M grader (per month)	\$4,500.00	\$27,900.00	\$3,231.67
CAT 120M grader (per year)	\$55,000.00	\$334,800.00	\$38,780.00

Owning and managing your own equipment is always the cheaper financial option, however, based asset criticality the benefits of inclusive leasing arrangements including access to specialised 24 hour maintenance providers can lead to better maintained equipment and limited downside risks associated with unplanned overhauls.



3.4 Decision Matrix

Based on the above analysis and conversation for Northam staff, the following decision matrix has been developed.

Management Strategy	Specialised Equipment	Utilisation	Skills Required	Response Urgency	Emergency Response	Comments
Internally Owned and Managed Equipment	Medium/Low	High	High or Low	Yes/No	Yes/No	It is financially optimal to own highly utilised equipment internally. Less specialised equipment that can be easily maintained and managed locally should be owned.
Leased Equipment with 24 hour callout assist	High	High	High or Low	Yes/No	Yes/No	Highly critical and specialised equipment should ideally be managed through leasing to optimise maintenance regimes and limit downside risk associated with rebuilds, combined with call out guarantees. Highly utilised and Equipment requiring urgent access to parts and labour for servicing require agreements with service provided able to meet these requirements. (20-30% mark up on internally managed equipment for the privilege)
Rental	High/low	Low	Low	No	No	Any equipment that has very low utilisation rates (<10%) that is not required in response to urgent or emergency situations should be rented when required.
External Contractor	High	Low	High	No	No	Highly specialised contractors should be used for non-core business jobs (low utilisation) that require specialist equipment and skills. The higher specialisation of skills the more attractive contracting becomes.

GHD ADVISORY
GHD Report for Shire of Northam - Shire of Northam
Reet Asset Review



3.5 Utilisation and Response Overview

Through consultation with EMES and EMCC staff, the current assessment of groups and their asset utilisations and urgency of response, is presented in Table 5.

Table 5: Qualitative assessment of group utilisation and importance

Group	Driver	Utilisation - Vehicles	Urgency Scale	Emergency Response	Management Strategy
Passenger	Pool	Medium	Medium	No	Review number of pool vehicles
Passenger	Rangers	High	High	Yes	Maintain Current Strategy
Passenger	Pool Vehicle	Medium	Medium	No	Review number of pool vehicles
Passenger	Tech Officer	Low	Low	No	Review number of pool vehicles
Passenger	EMES	High	High	No	Maintain Current Strategy
Passenger	Snr Health Officer	Low	Medium	No	Review number of pool vehicles
Passenger	Nadeem	High	Low	No	Maintain Current Strategy
Passenger	Jason Whiteaker	Medium	Medium	No	Review number of pool vehicles
Passenger	Colin Young	Low	Low	No	Review number of pool vehicles
Passenger	BM/PS	High	Medium	No	Maintain Current Strategy
Passenger	Sonny Rutherford	Low	Low	No	Review number of pool vehicles
Passenger	Kobus	Low	Low	No	Review number of pool vehicles
Passenger	EMDS	Low	Low	No	Review number of pool vehicles
Passenger	Killara	Low	Low	No	Review number of pool vehicles
Passenger	Community Bus	Low	Low	No	Not core business - Contract out
Passenger	EMCS	Medium	Low	No	Review number of pool vehicles
Passenger	REC CENTR MGR	Low	Low	No	Review number of pool vehicles
Parks and Gardens	Mowing Crew	Medium	Low	No	Consider contracting out/Review Hiring Options
Parks and Gardens	Verge Crew (Rural)	High	Low	No	Maintain Current Strategy
Parks and Gardens	Parks & Gardens	Medium	Low	No	Consider contracting out/Review Hiring Options
Operations	Construction Crew	High	High	Yes	Maintain Current Strategy
Operations	Drainage Crew-Urban	High	Low	Yes	Maintain Current Strategy
Operations	Flocon / Shoulder Crew	High	High	No	Maintain Current Strategy
Operations	Maintenance Crew	High	High	Yes	Maintain Current Strategy
Operations	Wundowie	Medium	Low	No	Consider contracting out/Review Hiring Options
Operations	Colin Lewis	Low	low	No	Review number of pool vehicles
Operations	Responce Crew	High	High	No	Maintain Current Strategy
Operations	Grounds Crew	High	low	No	Maintain Current Strategy



Group	Driver	Utilisation - Vehicles	Urgency Scale	Emergency Response	Management Strategy
Operations	Traffic Management	High	High	Yes	Maintain Current Strategy
Operations	Spray Crew	Medium	Low	No	Consider contracting out/Review Hiring Options
Operations	Litter Crew	Low	Low	No	Review number of pool vehicles
Operations	Inkpen tip	Medium	Low	Yes	Consider contracting out/Review Hiring Options
Operations	Wundowie Crew	Medium	Low	No	Consider contracting out/Review Hiring Options
Operations	Drainage Crew	High	Low	No	Maintain Current Strategy
Operations	Rural Drainage Crew	High	Low	No	Maintain Current Strategy
Operations	Maint. Grading Crew	High	Low	Yes	Maintain Current Strategy/Contract Out
Operations	Retc Officer	High	High	No	Maintain Current Strategy
Operations	Traffic Crew	High	High	No	Maintain Current Strategy
Operations	John Rutherford	High	High	Yes	Maintain Current Strategy
Operations	Rural Verge Crew	Medium	low	No	Consider contracting out/Review Hiring Options
Operations	Verge Crew	Medium	low	No	Consider contracting out/Review Hiring Options
Operations	Santo Leotta	High	High	Yes	Maintain Current Strategy
Operations	TM Crew	High	High	Yes	Maintain Current Strategy
Operations	Gardening Crew	High	Low	No	Maintain Current Strategy
Operations	Daniel	Medium	High	Yes	Maintain Current Strategy
Operations	Fire Chief	Medium	High	Yes	Maintain Current Strategy

3.6 Procurement Plan Impact

The revised strategy recommendations have been applied to the 'Plant Vehicle Replacement Program' with a focus on the current three year impacts. The key impacts on the program moving forward are:

1. 13 Passenger vehicles are set for renewal in the next three years and have been highlighted as potentially being fit for a pool vehicle allocation.
2. Extend renewal period for passenger vehicles out to 4 years after 2020.
3. Eight Low utilisation vehicles (predominantly mowing) should be deferred with the view of contracting out work
4. Two buses are set for renewal, consider not renewing vehicles and peruse an alternative solution



Year	Plant #	Detail	Driver	GHD Strategy Review	Life	Comment
2018/19	PN0908	N004 VOLVO BACHOE LOADER BL71	Drainage Crew- Urban	Maintain Current Strategy	7	As planned
2018/19	PN0004	SPEED ALERT TRAILER (S.A.M.)	Pool	Maintain Current Strategy	10	As planned
2018/19	PN2240	N.2240 WOOD CHIPPER 2005	Verge Crew (Rural)	Maintain Current Strategy	10	As planned
2018/19	P71	Cricket Wicket Roller	Grounds Crew	Maintain Current Strategy		As planned
2018/19	PN1501	PN1501-HINO WATER TRUCK (1DZ1621) 2012 MODEL (FM 500) 3 AXLE RIGID VEHICLE	Maint. Grading Crew	Maintain Current Strategy/Contract Out	7	As planned
2018/19	PN1514	MITSI TRITON 4x4	Rangers	Maintain Current Strategy	3*	As planned (defer next renewal 4-5 years)
2018/19	PN1401	MAZDA -BT50 TTOP 2014 WHITE PN1401 N10938	Traffic Crew	Maintain Current Strategy	3*	As planned (defer next renewal 4-5 years)
2019/20	PN1312	Fuso 815 Canter wide cab manual	Mowing Crew	Consider contracting out/Review Hiring Options	5	Review contracting services to manage works
2019/20	PN0916	N006 CLARK BOBCAT LOADER S205SJCH	Pool	Maintain Current Strategy	10	As planned
2019/20	PN1005	KUBOTA F3680 NS OUT FRONT MOWER WITH CANOPY & CATCHER	Pool	Consider contracting out/Review Hiring Options	5	Review contracting services to manage works
2019/20	PN1016	FEILDQUIP (JD) XHD SLASHER WITH DUAL TAIL WHEELS	Wundowie	Consider contracting out/Review Hiring Options	5	Review contracting services to manage works
2019/20	PN3555	PN3555 BL71 BACK HOE LOADER 2008	Construction Crew	Maintain Current Strategy	7	As planned
2019/20	PN0913	N3805 FUSO CANTER 4T TIPPER TRUCK WITH HIAB	Colin Lewis	Maintain Current Strategy	5	As planned
2019/20	P5017	P5017 DYNAPAC VIBRO ROLLER 2005	Flocon / Shoulder Crew	Maintain Current Strategy	7	As planned
2019/20	P542	P542 HOWARD PRO CUT MOWER 2008	Mowing Crew	Consider contracting out/Review Hiring Options	7	Review contracting services to manage works
2019/20	PN1009A	N5477 TWO WAY PIG TRAILER	Construction Crew	Maintain Current Strategy	5	As planned

GHD ADVISORY
GHD Report for Shire of Northam - Shire of Northam
Fleet Asset Review



Year	Plant #	Detail	Driver	GHD Strategy Review	Life	Comment
2019/20	PN1018	KOMATSU WA380 6 WHEEL LOADER INKPEN 2007	Inkpen tip	Consider contracting out/Review Hiring Options	5	Review contracting services to manage works
2019/20	PN1516	MAZDA BT50	BM/PS	Maintain Current Strategy	3*	As planned (defer next renewal 4-5 years)
2019/20	PN1406	TORO PRO CORE SR 75 HD DEEP TINE AERATOR	Mowing Crew	Consider contracting out/Review Hiring Options	5	Review contracting services to manage works
2019/20	PN1408	JOHN DEERE TRACTOR 2015 (N11063)	Mowing Crew	Consider contracting out/Review Hiring Options	5	Review contracting services to manage works
2019/20	PN1609	MITSUBISHI PAJERO SPORT GLS DIESEL 7 SEAT AUTO WHITE N11363	Colin Young	Review number of pool vehicles	3*	Review pool vehicle strategy (defer next renewal 4-5 years)
2019/20	PN1618	HOLDEN TRAIL BLAZER 7 SEAT DIESEL SILVER (N10721) EX MG ENGINEERING	EMES	Maintain Current Strategy	3*	As planned (defer next renewal 4-5 years)
2019/20	PN1601	MV1601 MAZDA CX-9 AZAMI AWD V6 PETROL AUTO WAGON GREY (N11206)(CEO)	Jason Whiteaker	Review number of pool vehicles	3*	Review pool vehicle strategy (defer next renewal 4-5 years)
2019/20	PN1407	MAZDA BT-50 4X2 SINGLE CAB DIESEL (N10996) WHITE T/TOP (2015)	John Rutherford	Maintain Current Strategy	3*	As planned (defer next renewal 4-5 years)
2019/20	PN1507	HOLDEN COMMODORE STORM SEDAN (N11114) WHITE PETROL (KILLARA)(PN1507)	Killara	Review number of pool vehicles	3*	Review pool vehicle strategy (defer next renewal 4-5 years)
2019/20	PN1614	FORD ESCAPE WHITE 2016 (N.3333)	Kobus	Review number of pool vehicles	3*	Review pool vehicle strategy (defer next renewal 4-5 years)
2019/20	PN1517	MITSI TRITON 4x4	Rangers	Maintain Current Strategy	4	As planned

GHD ADVISORY
GHD Report for Shire of Northam - Shire of Northam
Fleet Asset Review



Year	Plant #	Detail	Driver	GHD Strategy Review	Life	Comment
2019/20	PN1311	KILLARA HYUNDAI VF2 I40 2.0 AUTO WAGON (KILLARA3)	Pool Vehicle	Review number of pool vehicles	3*	Review pool vehicle strategy (defer next renewal 4-5 years)
2019/20	PN1605	ISUZU DMAX UTE 2016 DIESEL 4 X 2 N.4259 WKS SUPERVISOR 2016	Santo Leotta	Maintain Current Strategy	3*	As planned (defer next renewal 4-5 years)
2019/20	PN1519	MAZDA CX5 FWD AUTO 2016 SNR BUILDING SURVEYOR	Sonny Rutherford	Review number of pool vehicles	3*	Review pool vehicle strategy (defer next renewal 4-5 years)
2019/20	PN1613	MITSUBISHI OUTLAND AWD LS DIESEL 7 SEAT WAGON (N11069)(ASSET MANAGER)	Tech Officer	Review number of pool vehicles	3*	Review pool vehicle strategy (defer next renewal 4-5 years)
2019/20	PN1202	KILLARA2 BCI PROMA DX WHEELCHAIR BUS	Killara	Not core business - Contract out	7	Contract out bus services
2020/21	PN1415	PN1415 PEGASUS 200 VERGE MOWER - FLAT MOWER 2015	Mowing Crew	Consider contracting out/Review Hiring Options	7	Review contracting services to manage works
2020/21	PN1505	MITSUBISHI CHALLENGER 2015 WHITE (N11129)(PN1505)	Daniel	Maintain Current Strategy	3*	As planned (defer next renewal 4-5 years)
2020/21	PN1702	N11131- MAZDA CX-5 2017 GREY, 5 SEAT AUTO PETROL	EMCS	Review number of pool vehicles	3*	Review pool vehicle strategy
2020/21	PN1704	N.4030 FORD EVEREST SUV AMBIENTE 7 SEAT AUTO 4WD DIESEL	EMDS	Review number of pool vehicles	3*	Review pool vehicle strategy
2020/21	PN1607	TOYOTA HILUX DUAL CAB 4X4 WORKMATE CAB DIESEL N577	Fire Chief	Maintain Current Strategy	3*	As planned (defer next renewal 4-5 years)
2020/21	PN1520	MAZDA CX5FWD AUTO SNR HEALTH OFFICER	POOL	Review number of pool vehicles	3*	Review pool vehicle strategy
2020/21	PN1310	HYUNDAI 2014 VF2 I40 2.0 AUTO WAGON SILVER (KILLARA) PN1310	Pool Vehicle	Review number of pool vehicles	3*	Review pool vehicle strategy

GHD ADVISORY
GHD Report for Shire of Northam - Shire of Northam
Fleet Asset Review



Year	Plant #	Detail	Driver	GHD Strategy Review	Life	Comment
2020/21	PN1311	KILLARA HYUNDAI VF2 140 2.0 AUTO WAGON (KILLARA3)	Pool Vehicle	Review number of pool vehicles	3*	Review pool vehicle strategy
2020/21	PN1708	HOLDEN COLORADO UTE 4 X2 DUAL CAB (N11075)(REC MGR)	REC CENTR MGR	Review number of pool vehicles	3*	Review pool vehicle strategy
2020/21	PN1602	MV1602 MITSUBISHI TRITAN UTE - MANUAL DIESEL WHITE T/TOP N11291	Rural Verge Crew	Maintain Current Strategy	3*	As planned (defer next renewal 4-5 years)
2020/21	PN1220	N460 TOYOTA COASTER BUS DLX WUNDOWIE COMMUNITY BUS	Community Bus	Not core business - Contract out	10	Contract out bus services
2020/21	PN1308	TOYOTA HILUX WORKMATE MAN 2.7L PETROL WHITE	Wundowie	Maintain Current Strategy	3*	As planned (defer next renewal 4-5 years)

GHD ADVISORY
GHD Report for Shire of Northam - Shire of Northam
Fleet Asset Review

4. Recommendations and Conclusions

The section provides a summary of the recommendations and conclusions within the proceeding body of this report.

4.1 Passenger Vehicles

Based on the analysis provided in 3.2, it is recommended to move from three yearly replacement intervals to four yearly as this has potential to save up to 12 percent per year, whilst the vehicles continue to be covered by new car warranties with the recent changes. For example, Toyota has now moved to 5 years/unlimited kms warranties. The financial difference between leasing and owning has yearly cost implications of between 20-50 percent more for leasing vs owning.

Through discussions with staff, a number of vehicles have been identified as being under-utilised and should be converted to pool vehicles, see Table 5. When considering the case of whether an employee requires access to the pool vehicles or their own allocated vehicle, utilisation of vehicles and urgency of response requirements are the two key factors in the decision. Highly utilised vehicles or vehicles that are required to respond in urgent or emergency situations should be allocated to an individual.

4.2 Operations Vehicles

The dominant risk factor for operations equipment is the risk of major component rebuilds outside of warranty. Major rebuilds are expected occur between 8,000 and 15,000 hours. Major rebuilds should be managed proactively based on the risk associated with downtime. The cost associated with an unplanned rebuild including rental of replacement equipment is 60 percent of the vehicle new value. Without rental an estimate of 40 percent is used in the analysis.

Replacement should be considered at the end of warranty periods (varies by manufacturer) for highly utilised and important assets. If alternative equipment is available at the depot and a rental replacement is not immediately required, there is an opportunity to extend the asset replacement cycles, however regular condition assessments should be considered to cover the risk of unplanned rebuilds.

Based asset criticality the benefits of inclusive leasing arrangements including access to specialised 24 hour maintenance providers can lead to better maintained equipment and limited downside risks associated with unplanned overhauls.

GHD
Advisory

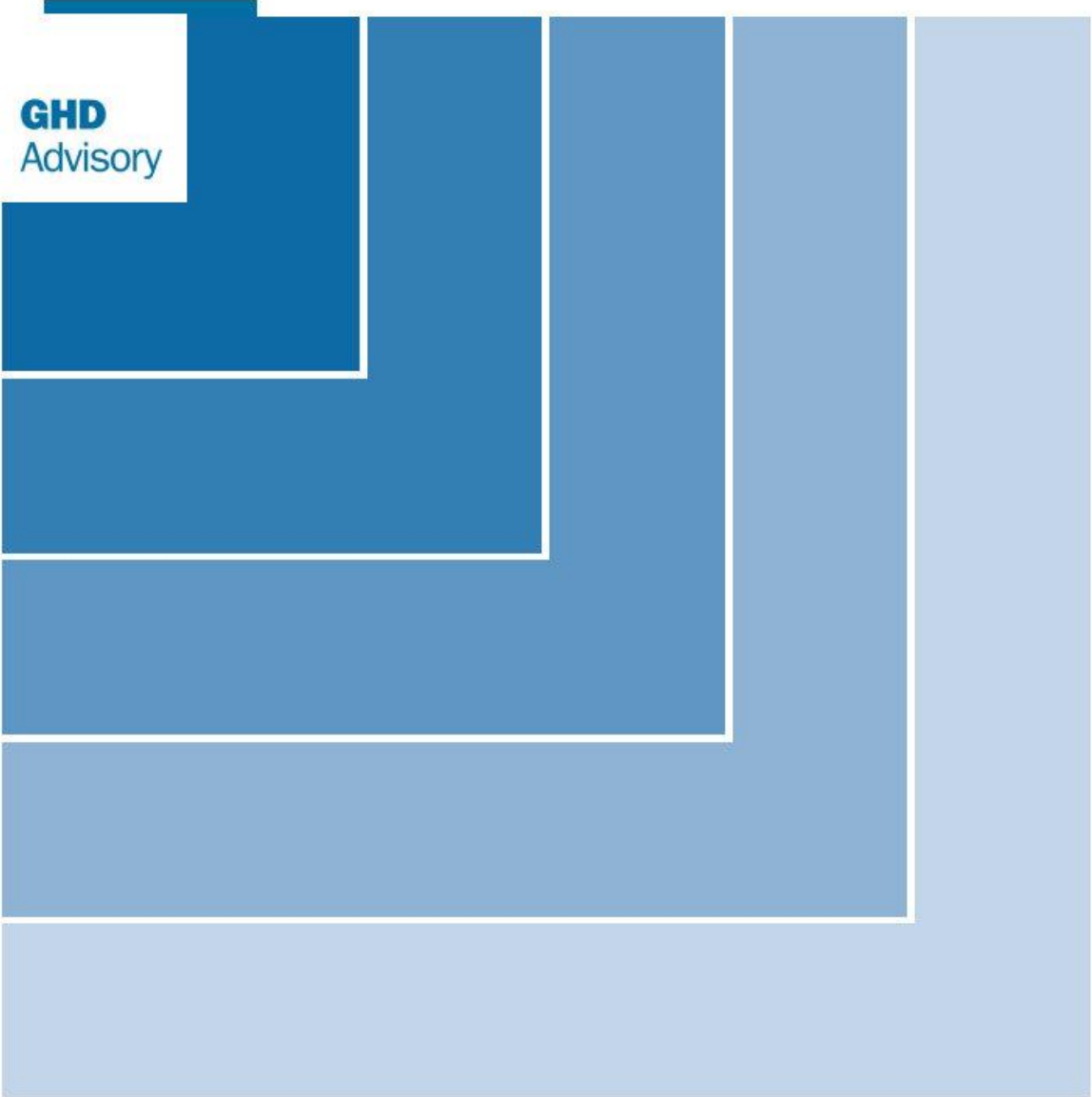



Level 10 999 Hay Street Perth WA 6000 Australia
PO Box 3106 Perth WA 6832 Australia

61 8 6222 8222
advisory@ghd.com

© GHD 2017. This document is and shall remain the property of GHD Advisory. The document may only be used for the purpose for which it was commissioned and in accordance with the Terms of Engagement for the commission. Unauthorised use of this document in any form whatsoever is prohibited.

Rev.No.	Author	Reviewer Name	Signature	Approved for Issue Name	Signature	Date
1	C.Pratt	M.Bourhill		M.Bourhill		26/03/2018

12.2.2 Shire of Northam W5.6 Verges Policy Review

Address:	N/A
Owner:	Shire of Northam
Applicant:	John Rutherford – Parks and Gardens Manager
File Reference:	2.3.1.2
Reporting Officer:	John Rutherford, Parks and Gardens Manager
Responsible Officer:	Clinton Kleynhans, Executive Manager Engineering Services
Officer Declaration of Interest:	Nil
Voting Requirement:	Simple Majority
Press release to be issued:	No

BRIEF

For Council to consider adopting the revised draft Policy W5.6 Verges Policy.

ATTACHMENTS

- Attachment 1: W5.6 Verges Policy, tracked changes.
Attachment 2: W5.6 Verges Policy, final.

A. BACKGROUND / DETAILS

W5.6 Verges Policy provides guidelines to the community generally to achieve aesthetically pleasing outcomes and environmental benefits and requires ongoing review to ensure it aligns with the Shires activities on thoroughfares, Public Places and Local Trading Laws and current community requirements.

Accordingly, a review has taken place as per below in Officers Comment.

B. CONSIDERATIONS

B.1 Strategic Community / Corporate Business Plan

Theme Area 4: Environment and Heritage.

Outcome: The Shire of Northam is visually pleasing and easy to find your way around.

Objective: Verges and Roadsides are neat, tidy and attractive.

Theme Area 5: Infrastructure and Service Delivery.

Outcome: Environmental risks are proactively managed to minimise impact on residents.

Objective: Verges and Roadsides are neat, tidy and attractive.

Theme Area 6: Governance & Leadership.

Outcome: The Shire of Northam is recognised as a desirable place to live and residents are proud to live here

Objectives: Positive internal and external perceptions about Northam.
Foster a sense of community pride.

B.2 Financial / Resource Implications

Nil.

B.3 Legislative Compliance

This Policy works in conjunction with the Local Planning Strategy and Shire of Northam Activities on Thoroughfares, Public Places and Local Trading Laws.

B.4 Policy Implications

Upon adoption of the proposed policy, it will be included in Councils current Policy Manual.

B.5 Stakeholder Engagement / Consultation

Reviewed by internal staff.

B.6 Risk Implications

Risk Category	Description	Rating (consequence x likelihood)	Mitigation Action
Financial	Non complying development verge approvals	Low (2)	Ensuring that approvals comply with Policy.
Health & Safety	Nil Where there is no footpath to have safe and clear access to the verge	Low/Low	Ensuring that approvals comply with Policy.
Reputation	The aesthetics of the verges is not maintained.	High (12)	With available resources to operational teams the staff are carefully dealing and this type of requests and taking action on it.
Service Interruption	No material Service interruption	Low (1)	Not required
Compliance	Each approval required to comply with the policy	Low (3)	Non-compliance may result in remedial works being undertaken at the owners cost

	To ensure that policy is reviewed as per Shire of Northam Corporate Business Plan		
Property	Property namely verges in which the Shire of Northam has a vested interest. Verges in which the community has been granted approval to developed.	Low (1) Low (1)	Not Required Approved applicants are required to maintain the verge to the required standard
Environment	Increase maintenance requirements	High (12)	Shire Northam will publicise this document to allow the onus to be placed back on the Community / Resident.

C. OFFICER'S COMMENT

The existing Policy was reviewed by staff with minor amendments made to reflect current practices and acceptable standards.

The following is a summary of the amendments made:

Section	Proposed alteration
	AMENDED/DELETED (select) – Detail reasoning
Cover Page	Deleted and written into title and Policies to match new policy formatting.
Purpose	Delete resident and replace with community.
Policy Application	Deleted Paragraph 1 and 2
Objective	Written content taken from original document titled "Purpose"
Vegetable Gardens	Removed as Vegetable gardens are no longer permitted.
Stormwater Infiltration	Water Removed "on site infiltration of stormwater is desirable as a means of contributing to the replenishment of ground water.
Reticulation	Paragraphs 2 & 3 joined together for formatting purposes. With the following statements removed: <i>Alternatively, the sprinklers should be the pop up variety or a type approved by the Shire;</i>

	<i>It is preferred to avoid reticulation of the verge altogether.</i>
Verge Compliance Criteria	Rewritten for formatting and clarity.
Verge Development Assistance Scheme	Deleted – no longer applicable to the Shire of Northam.
Verge Paving	Dot point 5, 6 and 7 removed as it is no longer applicable.
Existing Verges Treatments	Dot point 4 removed as it implies planter boxes are permitted.
Public Awareness	Removed as it no longer applies.
Glossary of Terms	Removed – not required in the new Policy format.
Verge Maintenance	Added service levels to be performed by the Shire on verges.

RECOMMENDATION

That Council adopt the proposed changes to the W5.6 Verges Policy as attached, and authorise the CEO to perform minor formatting changes to the Policy to the revised format.

MOTION / COUNCIL DECISION

Minute No: C.3782

Moved: Cr Williams

Seconded: Cr Ryan

That Council refer W5.6 Verges Policy back to staff for further consideration and the holding of an additional workshop with Elected Members to address concerns raised.

CARRIED 5/1

Reason for Change of Officer Recommendation

Council formed a view that additional workshopping of the draft policy was required to ensure the policy was reflective of Councils views on the management of this issue.

Attachment 1



Shire of Northam Policy Manual (Section 1)
Policy
W 5.6 Verges Policy

WORKS

W 5.6 Verges Policy

POLICY

~~As per attachment W 5.6.~~

~~The Shire supports the efforts of residents and property owners within the Shire designated townsites to develop and maintain verges that contribute to the aesthetic presentation of streetscapes and a sustainable quality environment for the community.~~

~~(To be read in conjunction with The Shire's Activities on Thoroughfares and Public Places and Trading Local Law and Policy 5.5 Street Trees)~~

OBJECTIVES

~~To provide guidelines to support and assist residents and the community generally to achieve aesthetically pleasing outcomes and environmental benefits, in conjunction with the Shire's Activities on Thoroughfares, Public Places and Local Trading Laws, but in a way that the Shire is not exposed to increased risk of liability claims.~~

~~To ensure a balance between legitimate off street parking requirements, streetscape enhancement by landscaping and on site filtration of storm water.~~

~~To manage and resolve hazards and safety issues~~

~~To ensure an equitable balance in the level of verge management carried out across the Shire towns.~~

~~To support and protect biodiversity.~~

- ~~• To value the verge as an important component of the streetscape~~
- ~~• To promote the principles of environmental sustainability and biodiversity~~
- ~~• To provide direction and guidance to the community on appropriate verge treatments~~
- ~~• To encourage ownership by owners to improve and maintain verge presentation~~
- ~~• To provide advice, regulatory control and incentives to property owners to improve verges to an appropriate and consistent stand~~



GUIDELINES	As attached to Policy W 5.6
HISTORY	Adopted: 19/09/2012
REVIEW	Executive Manager, Engineering Services

ATTACHMENT W 5.6 VERGES POLICY

1. BACKGROUND

The street verge has been traditionally described as the area between the road and boundary of an abutting property. The verge provides a safe pedestrian space and vehicular access to properties. The verge generally accommodates public service and local government utilities above and below ground such as street lighting, power, water, stormwater pipes, sewerage, gas and telecommunication cables. The service providers need to access their asset in the verge to install, maintain and/or repairs.

2. PURPOSE

- To value the verge as an important component of the streetscape
- To promote the principles of environmental sustainability and biodiversity
- To provide direction and guidance to residents on appropriate verge treatments
- To encourage ownership by owners to improve and maintain verge presentation
- To provide advice, regulatory control and incentives to property owners to improve verges to an appropriate and consistent stand

3. SCOPE3. POLICY APPLICATION

The Shire recognises that the appearance of street verges is important to owners / occupiers, due to the aesthetics impact on their dwellings and properties.

The following guidelines are provided to maintain safety to the community whilst enabling owners / occupiers to improve the aesthetics and amenity of street verges abutting to their properties.

Any person who wishes to carry out any works on the Verge shall do so in accordance with this policy, guidelines and specifications.

4. POLICY

Introduction



The street verge has been traditionally described as the area between the road and boundary of an abutting property. The verge provides a safe pedestrian space and vehicular access to properties. The verge generally accommodates public service and local government utilities above and below ground such as street lighting, power, water, stormwater pipes, sewerage, gas and telecommunication cables. The service providers need to access their asset in the verge to install, maintain and/or repairs.

The Shire will encourage and assist where practicable owners/ occupiers to maintain street verges in a way that retains and enhances the street scape whilst minimising water usage.

3.1 Community Value

Street verges facilitate an important role in the townscape environment. They provide aesthetic and environmental values, act as a buffer to street noise, provide shade and shelter, provide habitat for fauna and act as linkages, or vegetation corridors, between larger habitat nodes.

3.2 Pride and Ownership

Development, improvement and enhancement of verges promotes pride within the community and fosters a sense of verge ownership as an important and valuable component of streetscapes and open space within the townscape.

3.3 Amenity

Suitable and appropriate verge treatments contribute a significant value to the streetscape. The Shire and the community appreciate the visual amenity provided by verges that are maintained and improved by residents.

3.4 Natural Treatments

3.4.1 Grass verges are permitted; however, selection of a grass species that is water-wise, hardy and sustainable in verge conditions, including shade under trees is suggested.

3.4.2 Plantings of species indigenous to the local area and minimising the use of impervious surfaces are recommended.

3.4.3 Organic mulch is permitted to be installed on verges. However, the mulch is required to be replenished as required and maintained in a safe manner, and; shall not encroach surrounding areas outside the verge.

3.5 ~~Vegetable gardens~~

~~While the Shire encourages the planting of native species indigenous to the local area on verges, installation of vegetable gardens on the verge is permissible. Vegetable gardens on the verge should not stockpile waste, mulch or manure and all spent vegetation should be removed. Stakes, lattice and/or other supporting structures are not considered appropriate due to duty of care and safety reasons.~~



3.6 Hardstand Treatments

Concrete, segmented and permeable paving materials, artificial turf and other approved hardstand treatments are permitted to be used on the entire verge area. Installation of compacted inorganic materials (such as gravel, crushed brick, limestone or similar) on verges are permitted, subject to the size of the granular materials not causing hazards or inconvenience to pedestrians, cyclists and motorists.

3.7 Stormwater Water infiltration

~~On-site infiltration of stormwater is desirable as a means of contributing to the replenishment of groundwater.~~ Stormwater runoff from large sections of hard surfacing must be contained within the property, as the runoff can cause localised flooding on roads and adversely impact on the Shire's storm water disposal system and its maintenance.

3.8 Reticulation

3.8.1 Where the property owner wishes to install a permanent irrigation system on the verge the water supply is to be from within the adjacent private property boundary. All pipework is to be installed below ground and under footpaths. Sub-surface drip irrigation is preferred where possible to assist conservation of water. ~~Alternatively, the sprinklers should be the pop-up variety or a type approved by the Shire.~~

3.8.2 Reticulation may only be required to establish plants or water-wise verge treatments and this may be possible without the installation of a reticulation system.

~~3.8.3~~ Residents are encouraged to supply sufficient water to the base of the plant or to the plants drip-line to avoid wastage and unnecessary evaporation.

~~3.8.4 It is preferable to avoid reticulation of the verge altogether.~~

3.9 Non permissible Treatments/Use

3.9.1 The owner / occupier shall not install structures on the street verge. For example, tree house, play structures/equipment, fences, barriers, steps, walls, fountains, ornaments, basketball hoops, ornamental lighting or similar.

3.9.2 The owner / occupier shall not install extrinsic objects on the street verge. For example, bricks, rocks, logs, bollards, garden stakes, bunting, signs or similar.

3.9.3 The owner / occupier shall not install hard landscaping elements such as borders and or planter boxes around mature street trees.



3.9.4 The tethering of boats, trailers and other such items to street trees, street lights and/or road signs is not permitted due to safety issues and the potential to compromise the health of the tree and/or damage infrastructure.

3.10 Access by Utility Providers

Service providers, including the Shire, retain the right to access the verge for service maintenance works that may disrupt or damage any verge treatment.

4. VERGE COMPLIANCE CRITERIA

~~In order for applications to install landscape treatments on the verge to be approved, the following criteria will need to be met:~~

- ~~• Verge treatments are limited to low growing plants and ground covers that are nonhazardous to pedestrians, motorists, and/or cyclists. No plants taller than 75 centimetres in height are to be planted within 10 metres of a road junction or intersection, or in any location where they may obstruct visibility for road users or vehicles exiting from a crossover.~~
- ~~• The proposed landscaping provides a positive contribution to the aesthetic presentation of the streetscape.~~
- ~~• Landscaping does not create barriers within the verge.~~
- ~~• The plants are to be kept clear of the roadway and any footpath. If there is no footpath, a clear distance of 2 metres from the back of the kerb or edge of a carriageway is to be maintained to allow for the unrestricted passage of pedestrians.~~
- ~~• Where a bus stop exists within a verge, the proposed development must provide a minimum 1.5m clearance around the bus stop and between the bus stop and the foot path.~~
- ~~• Hedges or similar borders of plants are acceptable if planted to maintain, a minimum clearance of 50 centimetres from any existing and/or proposed footpath, and/or crossover and a minimum clearance of 2 metres from the back of kerb or edge of a carriageway.~~
- ~~• Reticulation sprinklers shall not be directed onto the footpath or road, and watering is to be restricted to times where any inconvenience to pedestrians, cyclists and motorists is minimised, and should only be watered on the properties allocated watering day.~~
- ~~• Appropriate measures are undertaken and maintained to minimise erosion and dust.~~
- ~~• The use of loose inorganic materials (stones / rocks / bricks) shall not be permitted, as these may cause potential hazard to pedestrians, cyclists and motorists.~~
- ~~• The use of any hard landscaping elements to create garden edging or retain soil adjacent to any proposed or existing footpaths, crossovers, and or kerbs shall not be permitted.~~
- ~~• Temporary barricades for the purpose of establishing verge landscaping are acceptable provided that the materials used do not create a hazard and are identified with an abundance of markers to ensure the safety of pedestrians.~~



Shire of Northam Policy Manual (Section 1)
Policy
W 5.6 Verges Policy

- Barriers must not be erected across pedestrian access ways, or in a manner which creates a sight line barrier / hazard.
- The general level and grade of the verges is to remain unaltered.
 - The treatment is not to create any undue hazard to road users or pedestrians.
 - The resident accepts responsibility for the removal or relocation of planting or reticulation if required by the Shire or any public authority and shall maintain the treatment so as not to cause a hazard.
 - Should the verge treatment become hazardous, the ratepayer shall agree to remove the treatment at his/her expense.
 - The ratepayer agrees to indemnify the Shire against any claims that may arise as a result of the treatment.
 - The verge shall not be used as a car park for any vehicle including cars, trucks, boats, caravans and so on.
 - The ratepayer shall not remove or prune any tree on street verge.
 - Prior to planting any tree on the road verge, the ratepayer is required to submit an application to the Shire, and obtain approval as per the Shire's "Street Tree Policy."
 - The resident is to inform the Shire in writing they wish to request the verge to be sprayed or to be placed on the "No Spray" list.
- 4.1 ~~Verge treatments are limited to low growing plants and ground covers and be non-hazardous to pedestrians, motorists, and/or cyclists. No plants taller than 75cm in height are to be planted within 10m of a road junction or intersection, or in any location where they may obstruct visibility for road users or vehicles exiting from a crossover.~~
- 4.2 ~~The proposed landscaping provides a positive contribution to the aesthetic presentation of the streetscape.~~
- 4.3 ~~Landscaping does not create barriers within the verge.~~
- 4.4 ~~Dense planting or other low maintenance forms of landscaping is acceptable.~~
- 4.5 ~~The plants are to be kept clear of the roadway and any footpath. If there is no footpath, a clear distance of 2 metres from the back of the kerb or edge of a carriageway is to be maintained to allow for the unrestricted passage of pedestrians.~~
- 4.6 ~~Where a bus stop exists within a verge, the proposed development must provide a minimum 1.5m clearance around the bus stop and between the bus stop and the foot path.~~
- 4.7 ~~The mature height of vegetation will be maintained below 750 mm. However, midstorey plants, particularly those that are indigenous to the area such as grass trees (Xanthorrhoea species) and banksias (Banksia species) are permissible so long as they are not planted within 10m of a road junction or intersection, or in any location where they may obstruct visibility for road users or vehicles exiting from a crossover.~~
- 4.8 ~~Hedges or similar borders of plants are acceptable if planted to maintain, a minimum clearance of 500 mm from any existing and/or proposed footpath, and/or crossover and a minimum clearance of 2,000 mm from the back of kerb or edge of a carriageway.~~



- ~~4.9 Reticulation sprinklers shall not be directed onto the footpath or road, and watering is to be restricted to times where any inconvenience to pedestrians, cyclists and motorists is minimised.~~
- ~~4.10 Appropriate measures are undertaken and maintained to minimise erosion and dust.~~
- ~~4.11 The use of loose inorganic materials (ie; gravels / stones / rocks / bricks) shall not be permitted, as these may cause potential hazard to pedestrians, cyclists and motorists.~~
- ~~4.12 The use of any hard landscaping elements to create garden edging or retain soil adjacent to any proposed or existing footpaths, crossovers, and/or kerbs shall not be permitted.~~
- ~~4.13 Temporary barricades for the purpose of establishing verge landscaping are acceptable provided that the materials used do not create a hazard and are identified with an abundance of markers to ensure the safety of pedestrians. Barriers must not be erected across pedestrian access ways, or in a manner which creates a sight line barrier / hazard.~~
- ~~4.14 The general level and grade of the verges is to remain unaltered.~~
- ~~4.15 The treatment is not to create any undue hazard to road users or pedestrians.~~
- ~~4.16 The applicant accepts responsibility for the removal or relocation of planting or reticulation if required by the Shire or any public authority.~~
- ~~4.17 The ratepayer shall maintain the treatment so as not to cause a hazard.~~
- ~~4.18 Should the verge treatment become hazardous, the ratepayer shall agree to remove the treatment at his/her expense.~~
- ~~4.19 The ratepayer agrees to indemnify the Shire against any claims that may arise as a result of the treatment.~~
- ~~4.20 The verge shall not be used as a car park for any vehicle including cars, trucks, boats, caravans and so on.~~
- ~~4.21 The ratepayer shall not remove or plant any tree on street verge. Requests for street trees shall be made to the Shire according to Policy 5.5 Street Trees.~~
- ~~4.22 Verge treatment shall not be over more than one third of the area of the verge (excluding any vehicle crossing).~~

5. VERGE DEVELOPMENT APPROVAL PROCESS

All proposals for landscape treatment of the verge require approval from the Shire of Northam.

In order for applications to install landscape treatments on the verge to be assessed, property owners are required to submit in writing an outline of the landscape proposal which includes a diagram to illustrate the proposed work including plant species and the layout of any proposed reticulation system(s).

The Shire will then:

- Inspect the location;
- Notify the owner in writing whether the Shire supports or does not support the proposed landscape development;



- On completion of any approved works the Shire will inspect the works;
- Works not carried out in accordance with the relevant approvals will require any noncompliance issues to be rectified; and
- Maintain a register of the site and the approved verge treatment.

6. VERGE DEVELOPMENT ASSISTANCE SCHEME

The objective of providing verge development assistance is to encourage and support property owners to develop and maintain verges that contribute to the aesthetic presentation of streetscapes and a sustainable quality environment for the community:

6.1 Verge Restoration:

The objective of providing verge restoration is to provide a better growing medium for low water demand plantings of low growing shrubs or ground cover plants other than turf. Existing soil/vegetation is removed from the verge to a depth of 50 mm below kerb/footpath levels and then replaced with fresh topsoil and levelled. Where a vehicular crossover is no longer used to gain access to the property, a verge restoration will include the removal of the redundant crossover. This scheme is available once only in every 10 years for individual properties.

6.2 Plant Subsidy:

Residential property owners can apply to purchase subsidised low water demand native plants for landscaping the street verge abutting to their properties. The objective of providing subsidised plants is to encourage residents to support biodiversity, water conservation, and the establishment of green corridors to link habitat areas within the townsites. The Shire will subsidise up to a maximum of 40 plants per property each year on a dollar for dollar basis. Plants are available through the native plant subsidy scheme run on an annual basis within the month of May.

6.3 Landscape Design Advice:

Plant selection advice and landscape design expertise is available to residential property owners requiring or seeking assistance in regard to verge landscaping. The Shire will subsidise assistance to a value of \$100. This scheme will be available once in every 5 years for individual properties.

Verge Development Assistance Scheme applications will be considered using the following criteria:

- Application must be from the property owner;
- An application for verge restoration will not be considered, where building work or activities within the property have damaged the street verge;
- The proposed verge treatment will improve and sustain the streetscape;



Shire of Northam Policy Manual (Section 1)
Policy
W 5.6 Verges Policy

- ~~• Preference will be given to native ground covers/shrubs with reduced water demands.~~
- ~~• Applications to participate in one of the above three Verge Assistance Schemes shall be submitted in writing to the Shire of Northam.~~

~~The availability of the verge development assistance scheme will be delivered within the limits of the available budget. Residents are therefore recommended to register their interest early in the financial year to avoid disappointment.~~

~~It is recommended property owners kill any existing turf prior to verge restoration to avoid resprouting. This may be done when the turf is actively growing (spring or autumn) by using weed control mats or biodegradable herbicides.~~

7. VERGE PAVING

Where there is a legitimate requirement for verge paving and there is no reasonable alternative property owners can apply to pave a portion of the verge directly adjacent to their property.

Proposals for verge paving require approval from the Shire of Northam.

Where the installation of paving to the verge is likely to compromise the safety of pedestrians, cyclists or motorists or the longevity of an existing street tree, the application will not be approved.

Where paving is proposed to provide a footpath between the property boundary and the kerb line, the path is to be 2.0 metres wide.

In order for verge paving proposals to be assessed the property owner is required to submit in writing an outline of their proposed paving plan with a diagram that illustrates the proposed location, alignment, and the materials to be used.

The Shire will then:

- Inspect the location.
- Notify the owner in writing of whether the Shire approves the application or not.
- On completion of the approved works, the Shire will inspect the works. Works not undertaken in accordance with the relevant approvals will require any noncompliance issues to be rectified.
- Maintain a register of the site and the approved verge treatment.
- ~~• The use of soil reinforcing cells will entitle the property owner to pave up to 70% of the adjacent verge.~~
- ~~• Where the road reserve is narrow and the verge contains a large and mature street tree with a wide spreading canopy, which overshadows the whole verge and which prohibits the establishment of ground covers the adjacent~~



~~residential property owner may apply to pave up to 70% of the verge consistent with the requirements of this policy.~~

- ~~• Where there is approval to install conventional clay or concrete paving to 70% of the verge the adjacent property owners must make provision for the on-site drainage of storm water within the verge. The adjacent property owner is required to provide detailed plans of the proposed method of storm water infiltration to the Shire for its consideration and approval. The use of soil reinforcing cells (which provide for storm water infiltration) will not require additional drainage provisions.~~
- A minimum two (2) metre paving clearance from any street tree is to be maintained.
- The property owner is to acknowledge in writing that any approved verge paving installed within the verge will be maintained by the property owner at grade consistent with the surrounding soil level at all times to ensure safe pedestrian access.
- The property owner is to acknowledge in writing that there is no responsibility on the part of the Council or utility service provider to reinstate verge paving removed to provide for routine maintenance of services or projects approved by Council.
- Commercial areas are treated separately from residential verges as paving is permitted to 100% of the verge in commercial areas.

8. PROPERTY DEVELOPMENT

To minimise the risk of tree damage/death a minimum construction clearance of two (2) metres is required from the base of an existing street tree. Where excavation to a depth greater than 100mm is proposed the clearance should be greater than three (3) metres from the base of an existing street tree.

9. EXISTING VERGE TREATMENTS

Where verge treatments are not consistent with the policy and are identified as safety hazards, the Shire will request the property owner to carry out remedial works.

Where the owner of the property is unable or unwilling to complete remedial works, the Shire will complete works. The property owner will be liable for the cost thus incurs.

Existing verge treatments, which are not consistent with this policy, are required to be rectified, on the following basis:

- Identified hazards or safety issues ie; tree houses, play equipment or any structure that has not been approved etc, boats and/or trailers tethered to street trees etc, landscaping that has thorns, spear like leaves or plants that are known to be toxic etc, landscaping that impedes sightlines/pedestrian access etc, [removal within 14 days of notification](#).



Shire of Northam Policy Manual (Section 1)
Policy
W 5.6 Verges Policy

- Rectification within 14 days of notification. Where an existing verge treatment is identified to present an immediate hazard, the Shire will rectify within 24 hours. The ratepayer abutting to the verge will be liable for the cost thus incurs.
- Paving (not approved by the Shire of Northam) in excess of areas defined in this policy is to be rectified within 60 days of notification.
- Hard Landscaping elements including boarders and or planted boxes is to be removed within 60 days.
- Planter boxes/borders not constructed to meet Australian Standards or industry standards; or constructed to a height greater than 150mm and/or within 500 mm of an existing footpath/crossover and/or within 2,000 mm of the kerb line, require rectification within 60 days.

All rResidents and commercial property owners are encouraged to maintain the verge adjacent to their property, for their own benefit, the benefit of their neighbours and the benefit of the wider Northam community.

10. PUBLIC AWARENESS

The Shire will acknowledge residents' efforts to develop a sustainable verge landscape via a 'Sustainable Verge Award' each year in spring. The award will target verge landscapes which contribute to the Shire's green objectives. The award is available for two categories' residential and commercial/schools.

The award is judged on the following criteria: biodiversity; water wise strategies; design; maintenance and any unique aspects. Nomination forms are available at the Administration Centre, and can be submitted from August to mid-September annually.

Public awareness programs to highlight the responsibilities of residents and the Shire on the issues of planting and maintenance of verge treatment will be undertaken, including articles placed from time to time (quarterly) in the Post newspaper and Talk about Northam newsletter. The articles should include all aspects of verge planting and maintenance, including responsibility and relevant Local Laws.

11. GLOSSARY OF TERMS

Street Verge: Portion of road reserve between the property boundary and edge of carriageway (kerb line).

Street Tree: A tree planted and maintained by the Shire and is typically situated at the 2.7 metre alignment off the property boundary.



Shire of Northam Policy Manual (Section 1)
Policy
W 5.6 Verges Policy

Verge Treatment: Landscaping of the portion of street verge not occupied by a footpath or crossover. Typically involves the planting of grass, ground covers or low shrubs and may include reticulation or paving.

Verge Restoration: The removal of any existing treatment and excavation of soil up to 100mm below existing paved levels. Topsoil is placed and levelled so that the new soil is flush with any existing paving (footpath, crossover, kerbing, etc).

Soft landscaping: Refers to grass, ground cover and shrubs

Hard Landscaping: Refers to retaining structures or edging / borders.

Paving: Refers to clay or concrete paving materials for footways or hardstand for parking of vehicles.

Structures: Refers to built structures

VERGE MAINTENANCE

The Shire encourages property owners to maintain and/or improve the verge area outside their property.

The Shire of Northam aims to create a visually pleasing community, inclusive of tidy and attractive verges and roadsides.

The Shire will perform an annual verge maintenance program consisting of the following where practicable:

- Town site verges will be sprayed at least once per year;
- Town site verges will be slashed once per year where the adjoining property is privately owned and vacant;
- Town site verges which adjoin property owned by the Shire will be slashed once a year and maintained to a standard that is deemed acceptable by Council;
- Rural verges will be sprayed and slashed on an ad-hoc basis.

Attachment 2

WORKS

W 5.6 Verge Policy

<i>Responsible</i>	Engineering Services
<i>Department</i>	
<i>Resolution Number</i>	
<i>Resolution Date</i>	19/09/2012
<i>Next Scheduled Review</i>	2021
<i>Related</i> <i>Shire</i>	
<i>Documents</i>	
<i>Related Legislation</i>	Local Government Act 1995

OBJECTIVE

- To value the verge as an important component of the streetscape
- To promote the principles of environmental sustainability and biodiversity
- To provide direction and guidance to residents the community on appropriate verge treatments
- To encourage ownership by owners to improve and maintain verge presentation
- To provide advice, regulatory control and incentives to property owners to improve verges to an appropriate and consistent stand

SCOPE

Any person who wishes to carry out any works on the Verge shall do so in accordance with this policy.

POLICY

Introduction

The street verge has been traditionally described as the area between the road and boundary of an abutting property. The verge provides a safe pedestrian space and vehicular access to properties. The verge generally accommodates public service and local government utilities above and below ground such as street lighting, power, water, stormwater pipes, sewerage, gas and telecommunication cables. The service providers need to access their asset in the verge to install, maintain and/or repairs.

The Shire will encourage and assist where practicable owners/ occupiers to maintain street verges in a way that retains and enhances the street scape whilst minimising water usage.

Community Value

Street verges facilitate an important role in the town site streetscape environment. They provide aesthetic and environmental values, act as a buffer to street noise, provide shade and shelter, provide habitat for fauna and act as linkages, or vegetation corridors, between larger habitat nodes.

Pride and Ownership

Development, improvement and enhancement of verges promotes pride within the community and fosters a sense of verge ownership as an important and valuable component of streetscapes and open space within the town site.

Amenity

Suitable and appropriate verge treatments contribute a significant value to the streetscape. The Shire and the community appreciate the visual amenity provided by verges that are maintained and improved by residents.

Natural Treatments

Grass verges are permitted; however, selection of a grass species that is water-wise, hardy and sustainable in verge conditions, including shade under trees is suggested.

Plantings of species indigenous to the local area and minimising the use of impervious surfaces are recommended.

Organic mulch is permitted to be installed on verges. However, the mulch is required to be replenished as required, and; maintained, and; shall not encroach surrounding areas outside the verge.

Hardstand Treatments

Concrete, segmented and permeable paving materials, artificial turf and other approved hardstand treatments are permitted to be used on the entire verge area. Installation of compacted inorganic materials (such as gravel, crushed brick, limestone or similar) on verges are permitted, subject to the size of the granular materials not causing hazards or inconvenience to pedestrians, cyclists and motorists.

Stormwater Water infiltration

Stormwater runoff from large sections of hard surfacing must be contained within the property, as the runoff can cause localised flooding on roads and adversely impact on the Shire's storm water disposal system and its maintenance.

Reticulation

Where the property owner wishes to install a permanent irrigation system on the verge the water supply is to be from within the adjacent private property boundary. All pipework is to be installed below ground and not disturb

footpaths. Sub-surface drip irrigation is preferred where possible to assist conservation of water.

Reticulation may only be required to establish plants or water-wise verge treatments and this may be possible with hard watering. Residents are encouraged to supply sufficient water to the base of the plant or to the plants drip-line to avoid wastage and unnecessary evaporation.

Non permissible Treatments/Use

The owner / occupier shall not install structures on the street verge. For example, tree house, play structures/equipment, fences, barriers, steps, walls, fountains, ornaments, basketball hoops, ornamental lighting or similar.

The owner / occupier shall not install extrinsic objects on the street verge. For example, bricks, rocks, logs, bollards, garden stakes, bunting, signs or similar.

The owner / occupier shall not install hard landscaping elements such as borders and or planter boxes around mature street trees.

The tethering of boats, trailers and other such items to street trees, street lights and/or road signs is not permitted due to safety issues and the potential to compromise the health of the tree and/or damage infrastructure.

Access by Utility Providers

Service providers, including the Shire, retain the right to access the verge for service maintenance works that may disrupt or damage any verge treatment.

VERGE COMPLIANCE CRITERIA

Applications to install landscape treatments on the verge will be required to meet the following criteria:

- Verge treatments are limited to low growing plants and ground covers that are nonhazardous to pedestrians, motorists, and/or cyclists. No plants taller than 75 centimetres in height are to be planted within 10 metres of a road junction or intersection, or in any location where they may obstruct visibility for road users or vehicles exiting from a crossover.
- The proposed landscaping provides a positive contribution to the aesthetic presentation of the streetscape.
- Landscaping does not create barriers within the verge.
- The plants are to be kept clear of the roadway and any footpath. If there is no footpath, a clear distance of 2 metres from the back of the kerb or edge of a carriageway is to be maintained to allow for the unrestricted passage of pedestrians.

- Where a bus stop exists within a verge, the proposed development must provide a minimum 1.5m clearance around the bus stop and between the bus stop and the foot path.
- Hedges or similar borders of plants are acceptable if planted to maintain, a minimum clearance of 50 centimetres from any existing and/or proposed footpath, and/or crossover and a minimum clearance of 2 metres from the back of kerb or edge of a carriageway.
- Reticulation sprinklers shall not be directed onto the footpath or road, and watering is to be restricted to times where any inconvenience to pedestrians, cyclists and motorists is minimised, and should only be watered on the properties allocated watering day.
- Appropriate measures are undertaken and maintained to minimise erosion and dust.
- The use of loose inorganic materials (stones / rocks / bricks) shall not be permitted, as these may cause potential hazard to pedestrians, cyclists and motorists.
- The use of any hard landscaping elements to create garden edging or retain soil adjacent to any proposed or existing footpaths, crossovers, and or kerbs shall not be permitted.
- Temporary barricades for the purpose of establishing verge landscaping are acceptable provided that the materials used do not create a hazard and are identified with an abundance of markers to ensure the safety of pedestrians. Barriers must not be erected across pedestrian access ways, or in a manner which creates a sight line barrier / hazard.
- The general level and grade of the verges is to remain unaltered.
- The treatment is not to create any undue hazard to road users or pedestrians.
- The resident accepts responsibility for the removal or relocation of planting or reticulation if required by the Shire or any public authority and shall maintain the treatment so as not to cause a hazard.
- Should the verge treatment become hazardous, the ratepayer shall agree to remove the treatment at his/her expense.
- The ratepayer agrees to indemnify the Shire against any claims that may arise as a result of the treatment.
- The verge shall not be used as a car park for any vehicle including cars, trucks, boats, caravans and so on.
- The ratepayer shall not remove or prune any tree on street verge.
- Prior to planting any tree on the road verge, the ratepayer is required to submit an application to the Shire, and obtain approval as per the Shire's "Street Tree Policy."
- The resident is to inform the Shire in writing they wish to request the verge to be sprayed or to be placed on the "No Spray" list.

VERGE DEVELOPMENT APPROVAL PROCESS

All proposals for landscape treatment of the verge require approval from the Shire of Northam.

In order for applications to install landscape treatments on the verge to be assessed, property owners are required to submit in writing an outline of the landscape proposal which includes a diagram to illustrate the proposed work including plant species and the layout of any proposed reticulation system(s).

The Shire will then:

- Inspect the location;
- Notify the owner in writing whether the Shire supports or does not support the proposed landscape development;
- On completion of any approved works the Shire will inspect the works;
- Works not carried out in accordance with the relevant approvals will require any noncompliance issues to be rectified; and
- Maintain a register of the site and the approved verge treatment.

Upon approval, it is advised that should it be required, the resident must follow the "Dial Before You Dig" process.

VERGE PAVING

Where there is a legitimate requirement for verge paving and there is no reasonable alternative property owners can apply to pave a portion of the verge directly adjacent to their property.

Proposals for verge paving require approval from the Shire of Northam.

Where the installation of paving to the verge is likely to compromise the safety of pedestrians, cyclists or motorists or the longevity of an existing street tree, the application will not be approved.

Where paving is proposed to provide a footpath between the property boundary and the kerb line, the path is to be 2 metres wide.

In order for verge paving proposals to be assessed the property owner is required to submit in writing an outline of their proposed paving plan with a diagram that illustrates the proposed location, alignment, and the materials to be used.

The Shire will then:

- Inspect the location.
- Notify the owner in writing of whether the Shire approves the application or not.

- On completion of the approved works, the Shire will inspect the works. Works not undertaken in accordance with the relevant approvals will require any noncompliance issues to be rectified.
- Maintain a register of the site and the approved verge treatment.
- A minimum two (2) metre paving clearance from any street tree is to be maintained.
- The property owner is to acknowledge in writing that any approved verge paving installed within the verge will be maintained by the property owner at grade consistent with the surrounding soil level at all times to ensure safe pedestrian access.
- The property owner is to acknowledge in writing that there is no responsibility on the part of the Council or utility service provider to reinstate verge paving removed to provide for routine maintenance of services or projects approved by Council.
- Commercial areas are treated separately from residential verges as paving is permitted to 100% of the verge in commercial areas.
- Upon approval, it is advised that should it be required, the resident must follow the “Dial Before You Dig” process.

PROPERTY DEVELOPMENT

To minimise the risk of tree damage/death a minimum construction clearance of two (2) metres is required from the base of an existing street tree. Where excavation to a depth greater than 100mm is proposed the clearance should be greater than three (3) metres from the base of an existing street tree.

EXISTING VERGE TREATMENTS

Where verge treatments are not consistent with the policy and are identified as safety hazards, the Shire will request the property owner to carry out remedial works.

Where the owner of the property is unable or unwilling to complete remedial works, the Shire will complete works at the owner’s expense.

Existing verge treatments, which are not consistent with this policy, are required to be rectified, on the following basis:

- Identified hazards or safety issues ie; tree houses, play equipment or any structure that has not been approved etc, boats and/or trailers tethered to street trees etc, landscaping that has thorns, spear like leaves or plants that are known to be toxic etc, landscaping that impedes sightlines/pedestrian access, removal within 14 days of notification.
- Rectification within 14 days of notification. Where an existing verge treatment is identified to present an immediate hazard, the Shire will rectify

within 24 hours. The ratepayer abutting to the verge will be liable for the cost thus incurs.

- Paving (not approved by the Shire of Northam) or in excess of areas defined in this policy is to be removed within 60 days of notification.
- Hard Landscaping elements including borders and or planted boxes is to be removed within 60 days.

All residential and commercial property owners are encouraged to maintain the verge adjacent to their property, for their own benefit, the benefit of their neighbours and the benefit of the wider Northam community.

VERGE MAINTENANCE

The Shire will perform an annual verge maintenance program consisting of the following where practicable:

- Town site verges will be sprayed at least once per year;
- Town site verges will be slashed once per year where the adjoining property is privately owned and vacant;
- Town site verges which adjoin property owned by the Shire will be slashed and maintained to a standard that is deemed acceptable by Council;
- Rural verges will be sprayed and slashed on an ad-hoc basis.

12.2.3 Wheatbelt Secondary Freight Network (WSFN)

Address:	N/A
Owner:	N/A
Applicant:	N/A
File Reference:	2.3.1.2
Reporting Officer:	Paul Kher, Engineering Technical Officer
Responsible Officer:	Clinton Kleynhans, Executive Manager Engineering Services
Officer Declaration of Interest:	Nil
Voting Requirement:	Simple Majority
Press release to be issued:	No

BRIEF

The purpose of the report is to inform Council on the progress of the Wheatbelt Secondary Freight Network (WSFN) project which was developed by the WSFN steering committee. The working group has developed a Governance Plan, Project Delivery Plan and Multi Criteria Analysis Methodology for review by all relevant local governments to formalise any comments provided and seek ongoing support for this project.

At this stage, 42 Local Governments within the Wheatbelt (South and North) are requested to provide their support and commitment to this project, with the focus on preparing and lodging a Stage 1 pilot project application for an amount of \$87.5 million for the preparation of a robust business case to support the project.

ATTACHMENTS

- Attachment 1: WSFN Program Governance Plan
- Attachment 2: WSFN Program Delivery Plan
- Attachment 3: WSFN Multi criteria Analysis Methodology
- Attachment 4: List of Roads In Wheatbelt North Region (Shire wise)

A. BACKGROUND / DETAILS

42 Local Governments of the Wheatbelt region have worked collaboratively for over 4 years to secure funding to improve secondary freight network routes on Local Government Roads in the Wheatbelt. The Wheatbelt Secondary Freight Network (WSFN) Program has successfully been allocated \$70 million of Federal funding (ROSI) and this has been matched with State funding of \$17.5 million (reflecting the 80/20 funding agreement). The State funding will be sourced two thirds from the State and one third from the local government whose assets are being upgraded. The available \$87.5M will not be sufficient to upgrade all of the identified 80 routes and good

governance of this program, and ongoing collaboration between all parties, will be critical in securing additional funding.

Attached is Program Governance Plan (PGP) which identifies how key governance and administrative aspects will be undertaken to ensure successful delivery of the program. It will assist to outline the structure and processes for decision making and consultation within the Wheatbelt Region Regional Road Groups (WR RRG) and Local Governments. The PGP will provide a framework and guidelines for all members of the WSN Program to operate within. The PGP will be used to communicate to all stakeholders how the program will be governed. This PGP should be read in conjunction with the attached Program Delivery Plan and the Multi-criteria Analysis (MCA) Methodology documents that provide operational details about how on-ground capital works will be delivered for Stage 1 and beyond.

Now that the initial funding for the delivery of on-ground capital works for Stage 1 has been confirmed, it is proposed that all 42 Local Governments formalise their commitment to WSN Program, to be eligible for future funding and project consideration. It is requested by the WSN Steering committee that this formal commitment from all 42 Councils be via a formal resolution of Council, which will entail the presentation and acknowledgement of the following WSN program documents:

- Project Governance Plan
- Program Delivery Plan
- Multi Criteria Analysis Methodology.

The 42 Council resolutions will be collated as addendums to a formal agreement that the Regional Road Group will sign with the Federal and State Governments on behalf of all 42 LGs associated with the WSN program formalising the ongoing commitment to the program.

In order to demonstrate best outcomes and value for money it is necessary to develop a transparent process to identify which routes have the highest priority for the limited available funding. A prioritisation of the Wheatbelt Secondary Freight Network routes will via a multi-criteria analysis (MCA) will be developed to score each route based on the available data submitted by Local Governments and the Revitalising Agricultural Region Freight (RARF) strategy being coordinated by the WA State Government. The criteria upon which each route will be assessed in the MCA includes:

Data Set	Description
ROSMA KSI Rate	ROSMA data will be supplied by Main Roads WA. It captures the rate of 'Killed or Serious Injury' (KSI) incidents on a route.
Seal Width	The seal width of the road described as a percentage of the route length, allowing an average seal width will be applied across the route. Seal width will be compared to a minimum seal width of 7m as per a Type 5 road.
Road Condition	Shire's have assessed road condition on a one to five scale, which has been applied as a direct metric. Five indicating very poor condition
ADT Counts	Average Daily Traffic counts provide data on the average number of total vehicles traveling on a road per day over the measurement period, capturing both heavy and light vehicle use.
ESA Counts	An Equivalent Standard Axle is defined as a dual tyred single axle transmitting 8.2 tonne to the pavement. ESA counts are therefore reflective of the total number and load of heavy vehicles that impact a road.

On-ground works for the WSN program are expected to commence in financial year 2020/21 and be staged over a 3 to 5 year period depending upon Federal Government stipulations.

For the year 2019/20 the WSN have identified 2 x pilot projects to begin on-ground works and refine project delivery methodologies and processes. These will be \$1 million dollars each and have been identified for the following Shires:

- Wheatbelt North
 - Shire of Victoria Plains
 - Lancelin to Meckering Route
 - Mogumber - Yarawindah Road
 - Project value \$1M
- Wheatbelt South
 - Shire of Quairading
 - Cunderdin to Kweda Route
 - Cunderdin - Quairading Road
 - Project Value \$1M

B. CONSIDERATIONS

B.1 Strategic Community / Corporate Business Plan

Theme Area 5: Infrastructure and Service Delivery

Outcome 5.3: To have safe, well-maintained community infrastructure and services to a standard expected of a Regional Centre.

Objectives:

- Deliver infrastructure projects effectively, on budget and schedule, aligned with local community plans and infrastructure projects.
- Build on community service delivery models to ensure services are continuously improved and modernised to meet community needs.
- Maintain an efficient and safe regional road network.

B.2 Financial / Resource Implications

Local Governments with projects approved over the course of the WSN program will be required to contribute approximately 7% of each individual project's total cost. The remaining funding will be provided by Federal Government 80% and State Government 13%.

B.3 Legislative Compliance

Nil.

B.4 Policy Implications

Nil.

B.5 Stakeholder Engagement / Consultation

This WSN project distributed among all 42 local governments in Wheatbelt region and RRGs (North & South), sub Groups and MRWA for comments.

B.6 Risk Implications

Risk Category	Description	Rating (consequence x likelihood)	Mitigation Action
Financial	If Council decide not to continue to support the project it may result in not being able to secure funding for Shires Roads part of this project.	Medium (3)	Without funding, the Shire of Northam will likely have to self-fund any upgrades of its own roads which will then carry higher class Restricted Access Vehicles received from adjoining LGA boundary.
Health & Safety	NA	N/A	N/A
Reputation	By not formalising Council's commitment in this project, the Shire of Northam could be perceived as not supporting the improvement of the freight network within the region.	High (4)	With available resources Shire will maintain and upgrade relevant RAV routes.
Service Interruption	NA	NA	NA
Compliance	The Shire of Northam road network will be perceived as non-compliant with heavy haulage industry as per current Restricted Access Vehicle Guide line. Operators will use roads which are non-compliant without approval.	Medium(3)	Ensure Council has enough funds to upgrade relevant RAV network as per current RAV guideline.
Property	NA	NA	NA
Environment	NA.	NA	NA

C. OFFICER'S COMMENT

Officers from LGs with prioritised projects will be essential to ensure successful delivery of individual projects. This will provide a great opportunity for knowledge sharing and collaboration across the region. It will allow members of the PTT to undertake both informal and formal training of LGA staff to upskill

and improve their technical capacity. Where possible neighbouring LGs will be encouraged to share technical, workforce and plant resources to assist in the efficient on-ground delivery of individual projects.

- Individual Shires will provide the following to the Steering Committee for approval before any funding will be released
 - Scope
 - Budget
 - Methodology
 - Delivery
- WSN 5 Year Plan incorporated in their LTFP.
- Individual Shires incorporate into Council Budgets Annually.
- Funding will be distributed to LGs via MRWA in accordance with Governance Plan.

RECOMMENDATION / COUNCIL DECISION

Minute No: C.3783

Moved: Cr Mencshelyi

Seconded: Cr Little

That Council:

- 1. Formalise their commitment to the program the Wheatbelt Secondary Freight Network Program enabling them to be eligible for future funding and project consideration.**
- 2. Receive the following WSN Program documents which outline how the WSN Steering Committee propose to administer the WSN Program:**
 - **Program Governance Plan**
 - **Program Delivery Plan**
 - **Multi Criteria Analysis Methodology.**
- 3. Endorse the processes and procedures outlined in the Program Governance Plan which enables the Wheatbelt North and Wheatbelt South Regional Road Groups and the WSN Steering Committee to make decisions in accordance with in the Program Governance Plan.**

CARRIED 6/0

Attachment 1



WSFN
WHEATBELT SECONDARY
FREIGHT NETWORK

PROGRAM
GOVERNANCE
PLAN

Table of Contents

- 1 Program Governance Outline 1
 - 1.1 Program Overview 1
 - 1.2 Goals 1
 - 1.3 Background 1
 - 1.4 Purpose of the Program Governance Plan..... 2
 - 1.5 Governance and Delivery 2
 - 1.6 Formal Agreement 2
- 2 Program Governance 4
 - 2.1 Federal Government 4
 - 2.2 State Government (Main Roads WA)..... 4
 - 2.3 Wheatbelt North and Wheatbelt South Regional Road Groups 5
 - 2.4 WSN Steering Committee 5
 - 2.5 Program Technical Team..... 6
 - 2.5.1 Program Technical Director 7
 - 2.5.2 Project Manager 7
 - 2.6 LGs 8

1 Program Governance Outline

1.1 Program Overview

The Wheatbelt Secondary Freight Network (WSFN) in the Main Roads WA Wheatbelt region comprises some 4,400km of Local Government managed roads that connect with State and National highways to provide access for heavy vehicles into the region. These roads are intended to enable large, high productivity trucks safe and cost-effective access to business. The WSFN project is developing a submission, with the supporting evidence and documentation required, to seek the addition of a program of road improvements across the network be added to the Infrastructure Australia (IA) Priority List.

The efficiency of supply chains serving industries in the Wheatbelt region is determined by the performance of the weakest link. Failure to maintain and improve productivity of the secondary freight network will reduce the international competitiveness of the Wheatbelt agricultural sector, which underpins employment and economic activity in the region. Transport links need to be addressed if the production of this sector is to be supported.

1.2 Goals

The 42 Local Governments (LGs) that collectively manage roads that comprise the Wheatbelt Secondary Freight Network are seeking to:

1. Efficiently deliver Stage 1 pilot projects funded through the Federal Government Roads of Strategic Importance (ROSI) program with State and Local Government co-contributions;
2. Develop a prioritised program of works for Stage 1 based on available funding (approximately \$87.5 million in funding for on-ground works), priority and deliverability.
3. Complete an "IA Stage 4 Business Case" submission covering the unfunded work needed to develop the WSFN to meet to industry requirements and submit this to Infrastructure Australia for inclusion on the Infrastructure Priority List (IPL).

1.3 Background

The 42 LGs of the Wheatbelt region have worked collaboratively for over 4 years to identify and now secure funding to improve secondary freight network routes on Local Government Roads in the Wheatbelt.

The 42 LGs have worked collaboratively with a number of State Government Departments to develop this plan and secure the Federal funding and this level of collaboration is unprecedented. In order to ensure ongoing success it is imperative that governance to deliver this program be established to administer the available funds and deliver the agreed outcomes in a transparent, reportable manner to the satisfaction of all parties; Local Governments, States Government and the Commonwealth.

\$70 million of Federal funding (ROSI) has been allocated and this has been matched with State funding of \$17.5 million (reflecting the 80/20 funding agreement). The State funding will be sourced two thirds from the State and one third from the Local Governments whose assets are being upgraded.

The available \$87.5M will not be sufficient to upgrade all the identified 80 routes and good governance of this program, and ongoing collaboration between all parties, will be critical in securing additional funding.

In addition to this the Shire of Koorda has received a REDS grant of \$100k for 2019/20 to engage a project manager for this project.

1.4 Purpose of the Program Governance Plan

The purpose of this Program Governance Plan (PGP) is to identify how key governance and administrative aspects will be undertaken to ensure successful delivery of the program. It will assist to outline the structure and processes for decision making and consultation within the Wheatbelt Region Regional Road Groups (WR RRG), their respective Sub-Groups and Local Governments. It will address who has responsibility for decision making on specific components. The PGP will provide a framework and guidelines for all members of the WSNF program to operate within. It also outlines how key administrative roles associated with program management such as stakeholder engagement, funding acquittal, project development and delivery and general correspondence will be undertaken. The PGP links all administrative tasks into a single concise document that members of the program governance team can regularly refer to.

The PGP will be used to communicate to all stakeholders how the program will be governed. It also provides a reference from which the governance of the program can be evaluated at any point in time and modified or improved as required.

1.5 Governance and Delivery

Given this funding is for Local Governments and all improvements are on Local Government assets it is appropriate that Local Government representatives determine program prioritisation, project selection, and appropriate standards and are responsible for design and delivery of the works.

It is proposed to split the Local Government responsibilities for this program delivery into three areas;

- Governance
 - Provide sound governance
 - Overall program management
 - Administration
- Management
 - Design and scoping of projects.
 - Delivery of individual identified projects
- Administration
 - Funding breakdown.
 - Funding acquittal.
 - Program agreements.

1.6 Formal Agreement

This PGP should be read in conjunction with the Program Delivery Plan and the Multi-criteria Analysis (MCA) Methodology documents that provide operational details about how the work will be delivered.

As outlined later in the PGP it is proposed that all 42 Local Governments are to formalise their commitment to WSNF Program, to be eligible for future funding and project consideration, via a formal resolution of Council, which will entail the presentation and acknowledgement of the following WSNF program documents:

- Project Governance Plan

- Program Delivery Plan
- MCA Methodology.

The 42 Council resolutions will be collated as addendums to a formal agreement (either a Deed of Agreement / Memorandum of Understanding, with exact terminology to be confirmed) that the Regional Road Group will sign with the Federal and State Governments on behalf of all 42 LGs associated with the WSN program formalising the ongoing commitment to the program.

The following provides an overview of the delegations and approval processes for each relevant stakeholder group associated with WSN program governance and delivery.

Document	WSFN Steering Committee	LG	RRG	MRWA
Formal Agreement	Prepare & Submit	Commit	Approve	Sign Off
Governance Plan	Prepare & Submit	Receive	Approve	Sign Off
Program Delivery Plan	Prepare & Submit	Receive	Endorse	Sign Off
Preliminary MCA	Prepare & Submit	Receive	Approve	Sign Off
Annual Report	Prepare & Submit	Receive	Receive	Receive
Staging Plan	Prepare & Submit	Receive	Endorse	Approve
Annual Program Budget	Prepare & Submit	Receive	Endorse	Sign Off
Specific Projects	Approve	Commit	Receive	Sign Off

The Program Delivery Plan will be a "live" document that will evolve as the program and its various projects are delivered. It is envisaged that this document incorporate various learnings undertaken over the course of the program.

2 Program Governance

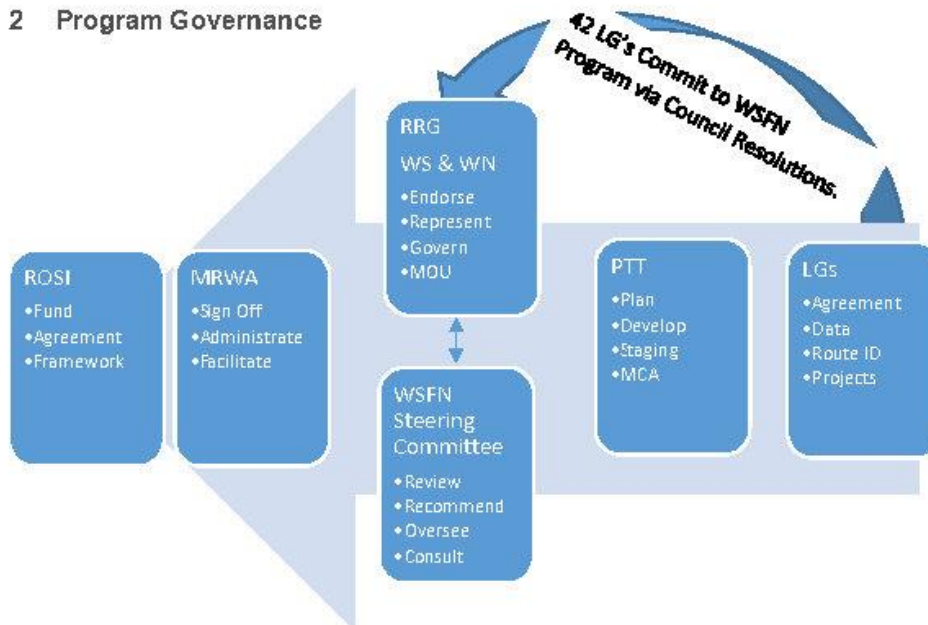

2.1 Federal Government

The Australian Federal Government intends to invest \$4.5 billion over ten years to the Roads of Strategic Importance (ROSI) initiative to help connect regional businesses to local and international markets, and better connect regional communities.

The WSFN Stage 1 prioritised program and on-ground capital works, up to a value of \$87.5 million, will be completed through the provision of Federal Government ROSI funds (\$70 million) along with matching State Government funds (\$11.7 million) and Local Government (\$5.8 million) co-contributions. The envisaged timeframe for this is 3 – 5 years subject to funding arrangements outlined by the Federal Government.

The Federal Government will:

- Provide guidance regarding program delivery and funding arrangements for WSFN program in-line with the ROSI requirements.
- Note Agreement between the 42 Local Governments of Wheatbelt North & Wheatbelt South Regional Road Groups (RRGs) regarding on-going support for investment in the WSFN and governance arrangements.
- Note a 5 year Staging Plan.
- Approve annual program plan through the Program Proposal Report (PPR).
- Provide funding to WA State Government via Main Roads WA in alignment with agreed milestones.

2.2 State Government (Main Roads WA)

Main Roads WA (MRWA) will represent the State Government in financial arrangements with the Commonwealth Department of Infrastructure, Transport, Cities and Regional Development and provide the link between the Federal Government and the WSFN. MRWA

will review the processes undertaken by RRGs, WSN and associated LGs and approve when satisfied that these process have been complied with.

Federal and State Government funding will be managed through Main Roads WA. Main Roads WA will fulfil the public financial administration role as it does with the Regional Road Groups.

- MRWA Wheatbelt Regional Manager to sign off on individual projects.
- MRWA Wheatbelt Regional Manager to ensure the various projects are delivered in accordance with the project plan
- MRWA to administer funds.
- Reporting implementation of the WSN Program will be an additional funding stream within the Wheatbelt North and Wheatbelt South Regional Road Groups.

2.3 Wheatbelt North and Wheatbelt South Regional Road Groups

The WSN Program will use existing governance structures and decision-making processes within the Wheatbelt North (WN) and South (WS) Regional Road Groups.

The RRGs will make decisions and endorse commitment of funds in accordance with agreed processes and procedures based upon advice from WSN Steering Committee and its Governance Plan. This approach would mitigate the need for every decision to be considered by all 42 Shires and would therefore enable swifter decision making. Its specific roles and responsibilities will entail:

- WS & WN RRGs to enter into a joint Agreement / Memorandum of Understanding (MOU) [specific terminology to be confirmed] representing all 42 LGs confirming their inclusion in WSN program.
- Receive and acknowledge Steering Committee decisions
- Endorse Governance Plan under which the Steering Committee will operate.
- Endorse Multi Criteria Assessment as recommended by Steering Committee
- Receive and Note the Annual Report as presented by Steering Committee
- Approve the program including back up projects (Staging plan).
- Approve the Annual program budget

Should WN & WS when approving programs not come to an agreed position it will be referred to mediation group comprising of RDA-W, WALGA and MRWA.

2.4 WSN Steering Committee

The purpose of the Steering Committee is to provide oversight and governance to the program.

The Steering Committee is made up of the following members:

Voting Delegates

- 2 x Wheatbelt North Regional Road Group (WN RRG) Elected Members
 - Chairperson plus 1 other delegate
- 2 x Wheatbelt South Regional Road Group (WS RRG) Elected Members
 - Chairperson plus 1 other delegate

Non-Voting Delegates

- WSN Program Technical Director

- WA Local Government Association (WALGA)
- Regional Development Australia - Wheatbelt (RDA-W)
- Main Roads WA - Wheatbelt Region (MRWA-WR)
- Wheatbelt Development Commission (WDC)

The Elected members are nominated to the Steering Committee for a two year term at the first RRG meeting following the LG elections. The Chairperson shall be elected at the first WSNF Steering Committee meeting following the LG elections.

Should the Steering Committee be unable to reach an agreed position it will be referred to mediation group comprising senior officers appointed by RDA-W, WALGA and MRWA.

The Steering Committee would work to set the goals and outcomes for the program in order for the Program Technical Team (refer Section 2.5) to develop a program brief and manage the consultant engagement process. Key roles would include:

- Set the goals and outcomes for the program.
- Provide political representation with State and Federal governments as well as their relevant authorities and departments.
- Identify funding opportunities and sources.
- Provide communication and consultation back to the WN and WS RRGs.
- Provide a collaborative approach to program delivery across multiple organisations.

The Steering Committee will recommend decisions and the commitment of funds to RRG in accordance with agreed processes and procedures outlined in WSNF Governance Plan.

Specific roles and responsibilities of the Steering Committee will be to:

- Review and recommended to RRGs
 - proposed routes within each sub-group.
 - approved Multiple Criteria Analysis process.
 - prioritisation of the 80 routes in accordance with the agreed Multi Criteria Assessment
 - work programs for future years and project prioritisation plans.
- Approve projects and allocation of project funding on an annual basis against agreed scope and budget with individual Shires.
- Consult and communicate with their respective sub-groups and member LGs.
- Ensure relevant information is presented to each RRG meeting for consideration.
- Prepare annual reports of achievements in the previous year
- Report on decisions made and program progress to Regional Road Groups and Main Roads

2.5 Program Technical Team

The PTT would be a technical working group consisting of the WSNF Program Technical Director and Project Manager as well as a Technical Advisor from each RRG.

The PTT will also have the ability to co-op specific technical resources as and when is required.

The role of the PTT will be to undertake a multi-organisational approach to deliver all the components of the program. Key responsibilities will entail.

- Engage consultants as required to deliver the program outcomes.
- Prioritise the 80 routes in accordance with the agreed Multi Criteria Assessment.
- Prepare work programs for future years.
- Prepare annual reports of achievements in the previous year.
- Prepare scope for future works to ensure consistency along identified routes.
- Allocate budgets against agreed scopes with individual Shires.
- Report on decisions made and program progress to Steering Committee and Working Group.

2.5.1 Program Technical Director

It is proposed that this role is undertaken by a representative of a Local Government within the Wheatbelt Regional Road Groups. Their roles and responsibilities will entail:

- Technical Member of the Steering Committee.
- Chairperson and coordination of PTT.
- Review of Project Brief and Budget as prepared by the Project Manager and present to Steering Committee.
- Oversee Project Manager in conjunction with employing LG.

The Steering Committee will make a recommendation to the RRGs to approve the appointment of Program Technical Director for a period an initial period of 3 years commencing October 2019, and every 2 years thereafter, outside of an election cycle.

2.5.2 Project Manager

The Project Manager will form part of the Program Technical Team and will be an integral key to successful program delivery. The complexity and scale of this program is significant and well beyond the technical and financial capabilities of the Wheatbelt Local Government staff on an individual basis. Engaging an external Project Manager with the skills and expertise required to work with the PTT, relevant LG officers as well as technical consultants will ensure a cohesive and collaborative environment is established for optimum outputs.

The Project Manager will direct the work of the external technical consultants and will be the main contact for communication between the PTT and external consultants.

Key roles of the Project Manager will be to undertake streamlined planning and coordination of activities associated with finalising the assessment, prioritisation and delivery of Stage 1 priority projects with relevant LGs. The activities include:

- Refine design criteria and develop preliminary standards and designs
- Consolidate existing data to gain an understanding of road user requirements, the physical site, and environmental context and constraints
- Undertake a study of quantified issues and opportunities, for input into route prioritisation.
- Collation and review of existing road condition and traffic data and program scopes.
- Identify priority projects and the proposed scope and timing for staged implementation of planned network
- Refine a route prioritisation MCA tool and conduct analysis of selected routes.
- Develop a route staging plan.

- Collection of additional, more detailed road condition and traffic data and project scope refinement.
- Site visits including cursory visual inspections would be undertaken to support desktop activities and to inform gap assessment.
- Development of detailed investigation and survey of Stage 1 priority projects. Supporting investigations that may be required which would include feature survey, environmental surveys, traffic surveys, utility services investigations (such as potholing), geotechnical and hydrological investigation.
- Development of "approved" and funded shovel ready projects
- Allocation for specific design or engineering investigations for immediate priority works (environmental, geotechnical, survey, detailed design).

The Shire of Koorda will be the auspice of the funding of the Project Manager for a nominal period of 3 years commencing 2019 (nominally October) as per the REDS Funding agreement.

2.6 LGs

- 42 Local Governments are to formalise their commitment to WSNF Program, to be eligible for future funding and project consideration, via a formal resolution of Council, which will entail the presentation and acknowledgement of the follow WSNF program documents:
 - Program Governance Plan
 - Program Delivery Plan
 - MCA Methodology.
- Provide necessary data to PTT to be utilised as part of MCA process and Staging Plan.
- Assist PTT with development of Staging Plan by identifying routes and assessing deliverability within the timeframes and parameters of the WSNF program.

Attachment 2



WSFN

WHEATBELT SECONDARY
FREIGHT NETWORK

PROGRAM DELIVERY PLAN

Table of Contents

- 1 Program Delivery 1
 - 1.1 MRWA 1
 - 1.2 Program Technical Team..... 2
 - 1.2.1 Program Technical Director 2
 - 1.2.2 Project Manager 2
 - 1.3 LGs 3
- 2 Project Administration 4
 - 2.1 Project Management Funding 4
 - 2.2 Capital Works Funding Administration 5
 - 2.2.1 Funding Breakdown 5
 - 2.2.2 Funding Acquittal 5
 - 2.3 Project Delivery..... 6

1 Program Delivery

The program delivery structure aims to utilise existing resources across the LGs of the Wheatbelt RRG with input from other key program Working Group member organisation representatives. It also outlines the engagement of a Lead Consultant to undertake project management of the external technical consultancy components of the project.

The WSFN has a strong project management and governance experience, which has been working on this project since 2017. The program has thus far been coordinated by the Working Group, with Garrick Yandle, CEO Shire of Kulin, (previously Executive Manager of Infrastructure with the Shire of Dandaragan) undertaking the role of Program Manager. The Working Group has been in close consultation with all member organisations, key stakeholders, as well as the design consultant and various state government regulatory authorities and potential funding bodies.

As part of the on-going delivery of the program the Working Group consists of the following:

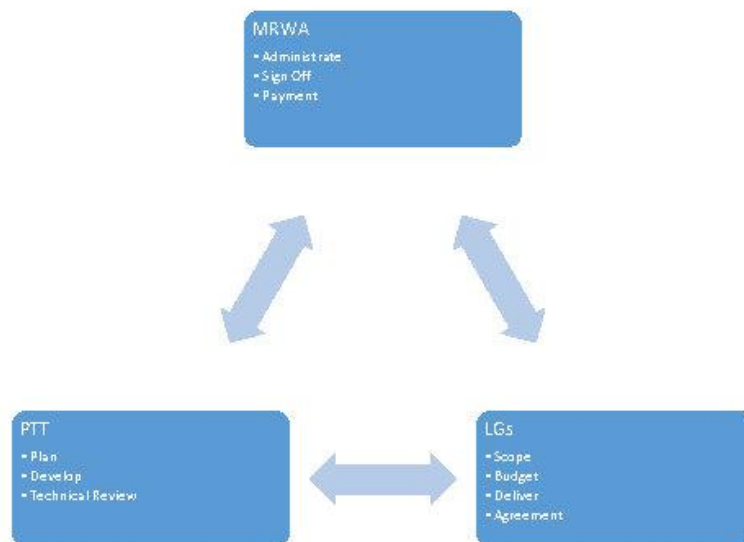

1.1 MRWA

Funding is to be channelled through Main Roads WA to each LG undertaking works. Main Roads will therefore process payments that are demonstrated to be in line with the agreed program management procedures.

- MRWA WR Manager to sign off on individual LGA Projects.
- MRWA to administer funds through the RRG Local Government Interface Manager (LGIM).
- MRWA WR Manager to ensure the various plans are being implemented

- Acquittal and review process for Certificates of Completion and Progress Payments is proposed to be.
 - Progress Payment Certificate - First 50% (once project is approved)
 - Completion Certificate - Final 50% (once project is completed)

1.2 Program Technical Team

The PTT would be a technical working group consisting of the WSN Program Technical Director and Project Manager as well as a Technical Advisor from each RRG.

The PTT will also have the ability to co-op specific technical resources as and when is required.

The role of the PTT will be to undertake a multi-organisational approach to deliver all the components of the program. Key responsibilities will entail.

- Engage consultants as required to deliver the program outcomes.
- Prioritise the 80 routes in accordance with the agreed Multi Criteria Assessment.
- Prepare work programs for future years.
- Prepare annual reports of achievements in the previous year.
- Prepare scope for future works to ensure consistency along identified routes.
- Allocate budgets against agreed scopes with individual Shires.
- Report on decisions made and program progress to Steering Committee and Working Group.

1.2.1 Program Technical Director

It is proposed that this role is undertaken by a representative of a Local Government within the Wheatbelt Regional Road Groups. Their roles and responsibilities will entail:

- Technical Member of the Steering Committee.
- Chairperson and coordination of PTT.
- Review of Project Brief and Budget as prepared by the Project Manager and present to Steering Committee.
- Oversee Project Manager in conjunction with employing LG.

The Steering Committee will make a recommendation to the RRGs to approve the appointment of Program Technical Director for a period an initial period of 3 years commencing October 2019, and every 2 years thereafter, outside of an election cycle.

1.2.2 Project Manager

The Project Manager will form part of the Program Technical Team and will be an integral key to successful program delivery. The complexity and scale of this program is significant and well beyond the technical and financial capabilities of the Wheatbelt Local Government staff on an individual basis. Engaging an external Project Manager with the skills and expertise required to work with the PTT, relevant LG officers as well as technical consultants will ensure a cohesive and collaborative environment is established for optimum outputs.

The Project Manager will direct the work of the external technical consultants and will be the main contact for communication between the PTT and external consultants.

Key roles of the Project Manager will be to undertake streamlined planning and coordination of activities associated with finalising the assessment, prioritisation and delivery of Stage 1 priority projects with relevant LGs. The activities include:

- Refine design criteria and develop preliminary standards and designs
- Consolidate existing data to gain an understanding of road user requirements, the physical site, and environmental context and constraints
- Undertake a study of quantified issues and opportunities, for input into route prioritisation.
- Collation and review of existing road condition and traffic data and program scopes.
- Identify priority projects and the proposed scope and timing for staged implementation of planned network
- Refine a route prioritisation MCA tool and conduct analysis of selected routes.
- Develop a route staging plan.
- Collection of additional, more detailed road condition and traffic data and project scope refinement.
- Site visits including cursory visual inspections would be undertaken to support desktop activities and to inform gap assessment.
- Development of detailed investigation and survey of Stage 1 priority projects. Supporting investigations that may be required which would include feature survey, environmental surveys, traffic surveys, utility services investigations (such as potholing), geotechnical and hydrological investigation.
- Development of "approved" and funded shovel ready projects
- Allocation for specific design or engineering investigations for immediate priority works (environmental, geotechnical, survey, detailed design).

The Shire of Koorda will be the auspice of the funding of the Project Manager for a nominal period of 3 years commencing 2019 (nominally October) as per the REDS Funding agreement.

1.3 LGs

Officers from LGs with prioritised projects will be essential to ensure successful delivery of individual projects. This will provide a great opportunity for knowledge sharing and collaboration across the region. It will allow members of the PTT to undertake both informal and formal training of LGA staff to upskill and improve their technical capacity. Where possible neighbouring LGs will be encouraged to share technical, workforce and plant resources to assist in the efficient on-ground delivery of individual projects.

- Individual Shires will provide the following to the Steering Committee for approval before any funding will be released
 - Scope
 - Budget
 - Methodology
 - Delivery
- WSFN 5 Year Plan incorporated in their LTFP.
- Individual Shires incorporate into Council Budgets Annually.
- Funding will be distributed to LGs via MRWA in accordance with Governance Plan.

2 Project Administration

As the WSNF Program and each individual LG project will be funded from three funding sources (Federal, State and Local Governments) it is important to clarify specific aspects with regards to the funding administration and delivery processes.

The Steering Committee put in separate funding submissions for a range of funding sources for both Management (administration, planning and design) Stage, as well as Capital Works Stage of the program. The program has been successful in obtaining funding from the following sources, as well as the required co-contribution from local governments:

Funding Source	Funding Amount	Stage
Regional Economic Development Grant	\$100K	Management
Local Government Co-contribution	\$252K 42 LGs x \$6K each	Management
Federal Government	\$70M	Capital Works
WA State Government	\$11.7M	Capital Works
Local Government	\$5.8M Individual LGs on project by project basis	Capital Works

2.1 Project Management Funding

The Project Manager is funded by the successful Regional Economic Development (RED) Grant through the WDC and acquitted by the Shire of Koorda. This specifically entails \$100K for a Project Manager to undertake project management.

The Project Manager will be initially contracted by the Shire of Koorda for a period of 3 years commencing 2019 (nominally October) as per the REDS Funding agreement.

Previously 42 local governments were asked to financially contribute to the WSNF project via a budget allocation of \$6,000 which was proposed to be part of a co-contribution towards BBRF. With the unsuccessful BBRF bid, it is proposed that the \$6,000 in financial contributions from each of the 42 local governments totalling \$252,000 be allocated to combine with the RED funding of \$100,000 to become project management pool of approximately \$350,000.

Funding Source	Funding Amount
RED Grant	\$100,000
Local Government Co-contribution	\$252,000
In Kind Contribution (approximately)	\$100,000
Project Management Total	\$452,000

This would contribute towards the overall project management requirements associated with the delivery of Stage 1 Priority Works over the course of an estimated 3 year delivery timeframe. Funding would contribute towards the following nominal requirements:

Role	Annual Funds	Comments
Project Manager	Nominal \$100,000 per annum of wages only	\$300,000 across 3 years
Project Administration and Communications Officer	Nominal \$20,000 per annum of wages only	\$60,000 across 3 years

Given the delivery of Stage 1 is likely to go over 5 years, then additional funding will be required for the Project Manager position. It is proposed that this additional funding be sourced via the contributing towards the LGs individual projects. A nominal figure for each project will be determined via the Steering Committee. As an example, a figure of 0.5% of total program funding (\$87.5M) would contribute approximately \$430K towards funding the Project Manager position. For each \$1M project approximately \$5,000 would be required to fund the Project Manager position. Individual LGs would still need to fund their own design, project management and project delivery of their individual projects.

Additional costs of vehicle and housing also likely to be required for the project manager position over the course the 5 years of delivery. The additional funding from each project would also contribute towards these additional costs.

Total project manager costs over 5 years are likely to be around \$750,000.

It is envisaged that an LG will advertise and employ the Project Manager over a 3 year period to work on the project on a part time basis. LGs with a desire to fulfil this role will be invited to make a submission to the WSNF Steering Committee for consideration. As indicated this contract will initially be managed by the Shire of Koorda for a period of 3 years commencing 2019 (nominally October) as per the REDS Funding agreement.

2.2 Capital Works Funding Administration

2.2.1 Funding Breakdown

The Australian Government will invest \$4.5 billion, including \$1 billion of additional funding committed in the 2019-20 Budget, to the Roads of Strategic Importance (ROSI) initiative to help connect regional businesses to local and international markets, and better connect regional communities.

Stage 1 priority program prioritisation and on-ground works, up to a capital value of \$90M, will be completed through the provision of Federal Government ROSI funds (\$70 million) along with matching State Government funds (\$11.7M) and Local Government (\$5.8M) co-contributions. The envisaged timeframe for this is 3 – 5 years.

Funding Source	Funding Ratio	Funding Amount
Federal (ROSI)	80%	\$70M
State	13.3%	\$11.7M
LGA (Own Source)	6.7%	\$5.8M
Total	100%	\$87.5M

The Federal Government's role will:

- Provide framework and guidelines for funding WSNF program via ROSI.
- Note Agreement with 42 LGs of WR RRG regarding WSNF.
- Note 5 year Staging Plan.
- Approve annual project plan.
- Provide funding to LG via WA State Government.

2.2.2 Funding Acquittal

Main Roads WA (MRWA) will represent the State Government in financial arrangements with the Commonwealth Department of Infrastructure, Transport, Cities and Regional Development and provide the link between the Federal Government and the WSNF. MRWA will review the processes undertaken by RRGs, WSNF and associated LGs and approve when satisfied that these process have been complied with.

Federal and State Government funding will be managed through Main Roads WA. Main Roads WA will fulfil the public financial administration role as it does with the Regional Road Groups.

- MRWA Wheatbelt Regional Manager to sign off on individual projects.
- MRWA Wheatbelt Regional Manager to ensure the various projects are delivered in accordance with the project plan
- MRWA to administer funds.
- Reporting implementation of the WSNF Program will be an additional funding stream within the Wheatbelt North and Wheatbelt South Regional Road Groups.
- Acquittal and review process for Certificates of Completion and Progress Payments is proposed to be.
 - Progress Payment Certificate - First 50% (once project is approved)
 - Completion Certificate - Final 50% (once project is completed)

2.3 Project Delivery

The following provides an overview of the key components associated with planning, development, scoping, prioritisation and delivery of on-ground works. It outlines how the Working Group, Steering Committee, PTT and LGs will work together towards successful project delivery.

Stage	Details
1. Program Staging Plan	<ul style="list-style-type: none"> ▪ PTT will develop a staging plan for program delivery. ▪ Relevant LGs will be informed of their proposed project and indicative budget, scope and year of delivery. ▪ Identification of Funds required for a 4 year program set in advance by project priority lists. ▪ Funding to be limited according to individual LG ability to deliver works.
2. Project Scoping and Approval	<ul style="list-style-type: none"> ▪ Stage 1 priority projects will be determined via the MCA process. ▪ Projects will be scoped and a preliminary budget developed by the PTT in-conjunction with individual LGs. ▪ Projects prioritisation will be undertaken via an MCA process by the PTT with input from relevant consultants as required. ▪ PTT will make recommendations to the Steering Committee for endorsement. ▪ The Steering Committee will then forward endorsed recommendations through to the relevant WN or WS RRG.
3. Detailed Scoping, Design and Budget Development	<ul style="list-style-type: none"> ▪ LGs will develop detailed budgets and designs (if necessary) for nominated Stage 1 priority projects. ▪ LGs are to include projects in their annual budget for the proposed year. ▪ LGs to be responsible for all relevant approvals.

	<ul style="list-style-type: none">▪ PTT to work with LGs to verify budgets.
4. Delivery	<ul style="list-style-type: none">▪ LGs will be responsible for tendering, project management and delivery of each project in the proposed year.▪ PTT to work with LGs to provide technical assistance and advice during delivery.▪ Incorporate into annual capital works program.▪ Works already funded from other sources are not eligible for funding under this program.▪ Cannot use existing funding sources, other than own sources funds, as co-contribution (ie not RRG or Roads to Recovery or Blackspot or Commodity Route funding sources)

Attachment 3



WSFN
WHEATBELT SECONDARY
FREIGHT NETWORK

MULTI-CRITERIA
ANALYSIS
METHODOLGY

In order to demonstrate best outcomes and value for money it is necessary to develop a transparent process to identify which routes have the highest priority for the limited available funding. A preliminary prioritisation of the Wheatbelt Secondary Freight Network routes was performed to provide an initial example of the future process and assist in identifying high-value routes. A simple multi-criteria analysis (MCA) was developed to score each route on the available data. This was undertaken as part of the Business Case development and funding submission process.

The objective of the MCA is therefore to accurately reflect the relative need for upgrade works for each route across the network. To achieve this, the MCA must be based on clear and justifiable scoring system that uses good-quality and verifiable data.

Following the Preliminary MCA development the WSN team have been able to obtain additional more detailed data from the Revitalising Agricultural Region Freight (RARF) strategy being coordinated by the WA State Government. This data will be distributed to the WSN Steering Committee via Main Roads WA. The additional data will be incorporated as part of the development of a Revised MCA.

This document summarises the Revised MCA methodology of prioritising the 80 Secondary Freight Routes of the WSN program.

The criteria upon which each route will be assessed in the MCA includes:

- Average Daily Traffic
 - as submitted by LGAs
 - which would actually be "peak season" traffic
- Equivalent Standard Axles / per day
 - as submitted by LGAs
 - which would actually be "peak season" traffic
- Seal Width
 - Linearly relates to percentage of road below minimum 7M requirement for seal width.
- Road Safety
 - ROSMA as per RARF data
 - KSI
- Road Condition Data
 - as submitted by LGAs
 - Simple Condition Grading Model - IPWEA, 2015, IIMM, Sec 2.5.4

Input Data

Data will be collated from a range of sources as summarised below. These data sources fall under two general categories, relating either to the condition or utilisation of each route (see further explanation below):

Category	Data Set	Description
Condition	ROSMA KSI Rate	ROSMA data will be supplied by Main Roads WA. It captures the rate of 'Killed or Serious Injury' (KSI) incidents on a route.
Condition	Seal Width	The seal width of the road described as a percentage of the route length, allowing an average seal width will be applied across the route. Seal width will be compared to a minimum seal width of 7m as per a Type 5 road.
Condition	Road Condition	Shire's have assessed road condition on a one to five scale, which has been applied as a direct metric. Five indicating very poor condition
Utilisation	ADT Counts	Average Daily Traffic counts provide data on the average number of total vehicles traveling on a road per day over the measurement period, capturing both heavy and light vehicle use.
Utilisation	ESA Counts	An Equivalent Standard Axle is defined as a dual tyred single axle transmitting 8.2 tonne to the pavement. ESA counts are therefore reflective of the total number and load of heavy vehicles that impact a road.

MCA Process

The MCA will use a three-step process to incorporate all routes into a final ranking system:

- Each set of data is scored on a consistent scale (e.g. 1 to 5) based the range of results in the data set. For example, if average daily traffic counts (ADT) range from a minimum of 100 to a maximum of 600 then the following scores could be applied (example only):

ADT Range	ESA Range	Seal Width (m)	ROSMA (KSI)	Road Condition	Score
100 – 199	0 - 25	> 8	0	Excellent: only planned maintenance required	1
200 – 299	25 – 50	7 - 8	0.2	Good: minor maintenance required plus planned maintenance	2
300 – 399	50 - 75	6 - 7	1	Fair: significant maintenance required	3
400 – 499	75 – 100	5 - 6	1.5	Poor: significant renewal/rehabilitation required	4
500 - 600	> 100	< 5	2	Very Poor: physically unsound and/or beyond rehabilitation	5

- The scores for each set of data are then combined using weightings (%) to reflect the importance of each set of results in establishing the need for works (example below). This system will be supported by a descriptive justification for the weighting applied to each set of data:

Data Set	Example Score	Weighting	Final Score
A	2	10%	0.2
B	3	20%	0.6
C	4	30%	1.2
D	1	40%	0.4
Total		100%	2.4 out of 5

- The final score for all routes are then compared to rank the routes according to a simple priority system e.g. high, medium and low.

Application of Weightings

The weightings applied to each set of data must be reflective of the actual need for upgrade/repair works. At a high level, the need for the works stems from:

- The current condition of the route and how far this is from an ideal standard
- How much the route will be utilised, primarily by heavy vehicles

Anecdotal feedback to-date has been that heavy vehicles generally choose routes based on travel time, irrespective of road condition. The result being that particular routes will quickly deteriorate if they are not maintained to a high standard – at significant cost to the affected Local Government. As an initial base it is therefore proposed that Condition and Utilisation categories collectively each receive equal weightings of 50%. This initial system is illustrated below:

Category	Suggested Category Weighting	Data Sets	Individual Weighting
Condition	50%	KSI Rate Seal Width Road Condition	To be developed (sum to 50%)
Utilisation	50%	ADT ESA	To be developed (sum to 50%)

It is noted that a higher weighting has been applied to ESA counts as this is reflective of the number of freight vehicles. Freight vehicles account for the majority of road costs and potential benefits through reduced VOC and repairs/reconstruction costs, these costs are generally proportional to total ESA numbers.

Under this system a highly utilised route in moderate condition may be prioritised over a route that is in poor condition but is seldom used. In refining and finalising the MCA weightings, agreement will need to be reached on what weightings approach will achieve the best value-for-money considering the root causes of costs and the expected future utilisation of each route.

Attachment 4

WN RRG Wheatbelt Collector freight Route List									
Route Details					Road Asset Data				
ROAD No.	Route No.	Collector Route Name	SRRG	LGA	Road Name	Start SLK	Terminus SLK	Length (km)	RAV Network Rating
5020003				Chittering	Dewars Pool - Bindoon Rd	0	9.4	9.4	2
5030005				Dalwallinu	Dalwallinu West Rd	0	5.4	5.4	7
5030026				Dalwallinu	Locke Rd	6.02	10.03	4.01	7
5030027				Dalwallinu	Bell Rd	0	27.81	27.81	7
5030085				Dalwallinu	Miling North Rd	0	1.32	1.32	4
5030094				Dalwallinu	Rabbit Proof Fence Rd	14	49.35	35.35	8
5030231				Dalwallinu	Carot Well Rd	0	3.02	3.02	7
5030241				Dalwallinu	Dalwallinu - Kalannie Rd	0	31.47	31.47	7
				Dalwallinu	Dalwallinu - Kalannie Rd	31.47	51.7	20.23	10
5030242				Dalwallinu	Dowerin - Kalannie Rd	0	10.07	10.07	10
5030244				Dalwallinu	Roche St	0	0.95	0.95	10
5070002				Gingin	Gingin Brook Rd	0	29.15	29.15	4
5070003				Gingin	Cowalla Rd	29.99	36.49	6.5	4
5070006				Gingin	Orange Springs Rd	0	17.86	17.86	4
5070007				Gingin	Sappers Rd	0	11.83	11.83	4
5070008				Gingin	K.W. Rd	0	6.75	6.75	4
5070011				Gingin	Mogumber Rd West	0	24.95	24.95	4
5070066				Gingin	Old Ledge Point Rd	0	3	3	4
5070417				Gingin	Lancelin Rd	0	3.06	3.06	4
5100005				Moora	Watheroo West Rd	0	18.15	18.15	4
5100021				Moora	Carot Well Rd	0	27.33	27.33	4
5100026				Moora	Railway Rd	0	2.46	2.46	4
5100085				Moora	Gardiner St	0	0.21	0.21	7
5100192				Moora	Dandaragan St	0	1.63	1.63	6
5100193				Moora	Moora - Caro Rd	0	8.5	8.5	6
5100194				Moora	Berkshire Valley Rd	0	0.69	0.69	4
5100195				Moora	Moora - Miling Rd	0	35.76	35.76	4
5170006				Victoria Plains	Mogumber - Yarawindah Rd	0	18.04	18.04	5
5170008				Victoria Plains	Calingiri - New Norcia Rd	0	28.02	28.02	5
5170015				Victoria Plains	Mogumber West Rd	0	9.56	9.56	5
5170123				Victoria Plains	Goomalling - Calingiri Rd	0	21.02	21.02	5
5170124				Victoria Plains	Toodyay - Bindi Bindi Rd	23.23	24.58	1.35	5
5170125				Victoria Plains	Toodyay - Bindi Bindi Rd	0	0.55	0.55	5
4080001				Goomalling	Goomalling - Meckering Rd	0	22.7	22.7	4
4080107				Goomalling	Goomalling - Calingiri Rd	0	30.32	30.32	5
4070002				Dowerin	Redding Rd	0	0.9	0.9	5
4070023				Dowerin	Koorda - Wongan Hills Rd	13.92	23.43	9.51	5
4070181				Dowerin	Stewart St	0.62	1.44	0.82	5
4070182				Dowerin	Dowerin - Kalannie Rd	0	48.76	48.76	5
5180006				Wongan - Ballidu	Manmanning Rd	0	7.59	7.59	6
				Wongan - Ballidu	Manmanning Rd	7.59	32.11	24.52	4
5180139				Wongan - Ballidu	Oliver Rd	0	1.67	1.67	6
5180192				Wongan - Ballidu	Burakin - Wialki Rd	0	6.83	6.83	6
5180193				Wongan - Ballidu	Dowerin - Kalannie Rd	0	3.95	3.95	5
					Dowerin - Kalannie Rd	3.95	4.27	0.32	6
					Dowerin - Kalannie Rd	4.27	34.53	30.26	5
					Dowerin - Kalannie Rd	34.53	34.83	0.3	6
					Dowerin - Kalannie Rd	34.83	43.45	8.62	5
5180195				Wongan - Ballidu	Hospital Rd	7.43	24.99	16.96	6
5180197				Wongan - Ballidu	Wongan Hills - Cadoux Rd	0	22.47	22.47	6
5180198				Wongan - Ballidu	Cadoux - Koorda Rd	0	7.2	7.2	6
4080001				Goomalling	Goomalling - Meckering Rd	0	22.7	22.7	4
4080107				Goomalling	Goomalling - Calingiri Rd	0	30.32	30.32	5
4070002				Dowerin	Redding Rd	0	0.9	0.9	5
4070023				Dowerin	Koorda - Wongan Hills Rd	13.92	23.43	9.51	5
4070181				Dowerin	Stewart St	0.62	1.44	0.82	5
4070182				Dowerin	Dowerin - Kalannie Rd	0	48.76	48.76	5
4212226				Northam	Yigarn Ave	0	3.52	3.52	7
4260194				Toodyay	Dewars Pool - Bindoon Rd	0	24.6	24.6	2
4260197				Toodyay	Toodyay - Bindi Bindi Rd	0	33.4	33.4	4
58				Toodyay	Harper Rd	0	0.17	0.17	4
61				Toodyay	Anzac Avenue	0	0.06	0.06	4
126				Toodyay	Hammersley Street	0	0.68	0.035	4
195				Toodyay	Stirling Terrace	0	0.1	0.1	4
196				Toodyay	Telegraph Road	0	0.03	0.03	4

WN RRG Wheatbelt Collector freight Route List									
Route Details					Road Asset Data				
ROAD No.	Route No.	Collector Route Name	SRRG	LGA	Road Name	Start SLK	Terminus SLK	Length (km)	RAV Network Rating
1				York	York Tammin	0	33.51	33.51	4
4110002				Koorda	Cadoux - Koorda Rd	0	21.73	21.73	6
4110135				Koorda	Wyalkatchem - Koorda Rd	0	17.3	17.3	6
4110136				Koorda	Aitken Rd	0	0.42	0.42	6
4110137				Koorda	Railway St	0	0.74	0.74	6
4110138				Koorda	Haig St	0	0.96	0.96	6
4110139				Koorda	Koorda - Bullfinch Rd	0	10.47	10.47	6
4110140				Koorda	Burakin - Wialki Rd	0	36.63	36.63	6
4150145				Mount Marshall	Koorda - Bullfinch Rd	0	47.98	47.98	7
4150146				Mount Marshall	Monger St	0	1.14	1.14	6
4150149				Mount Marshall	Bencubbin - Beacon Rd	0	19.47	19.47	6
4150149				Mount Marshall	Bencubbin - Beacon Rd	19.47	42.22	22.75	7
4150150				Mount Marshall	Burakin - Wialki Rd	0	51.15	51.15	7
4150151				Mount Marshall	Kellerberrin - Bencubbin Rd	0	14.35	14.35	6
4150152				Mount Marshall	Mukinbudin - Wialki Rd	0	10.42	10.42	7
6				Mount Marshall	INGLETON ROAD	0	30.77	30.77	7
142				Mount Marshall	WATSON COURT	0	0.24	0.24	4
157				Mount Marshall	KIRBY STREET	0	0.24	0.24	7
4160007				Mukinbudin	Nungarin North Rd	0	10.7	10.7	6
4160022				Mukinbudin	Mcgregor Rd	0	2.51	2.51	4
4160068				Mukinbudin	Strugnell St	0	0.78	0.78	7
4160107				Mukinbudin	Koorda - Bullfinch Rd	0	41.39	41.39	7
4160110				Mukinbudin	Mukinbudin - Wialki Rd	0	42.92	42.92	7
4220001				Nungarin	Nungarin North Rd	2.67	23.05	20.38	6
4220064				Nungarin	Koorda - Bullfinch Rd	0	9.87	9.87	7
4130072				Trayning	Sutherland St	0	0.72	0.72	5
4130099				Trayning	Kellerberrin - Bencubbin Rd	0	31.34	31.34	5
4130100				Trayning	Twine St	0	0.49	0.49	5
4130101				Trayning	Kellerberrin - Bencubbin Rd	0	20.29	20.29	5
4060002				Cunderdin	Goomalling - Meckering Rd	0	20.07	20.07	5
4060082				Cunderdin	Olympic Av	0	0.48	0.48	7
4060148				Cunderdin	Carter Dr	0	0.77	0.77	7
4060163				Cunderdin	Cubbine St	0	1.38	1.38	6
4060164				Cunderdin	Quairading Rd	0	21.67	21.67	6
4060165				Cunderdin	Baxter Rd	0	0.73	0.73	7
4060166				Cunderdin	Cunderdin - Wyalkatchem Rd	0	12.85	12.85	7
4060166				Cunderdin	Cunderdin - Wyalkatchem Rd	12.85	30.68	17.83	5
4060167				Cunderdin	Dunlop St	0	0.17	0.17	5
4090001				Kellerberrin	Kellerberrin - Shackleton Rd	0	25.52	25.52	4
4090082				Kellerberrin	Mather Rd	0	17.95	17.95	4
4090119				Kellerberrin	Dowding St	0	2.88	2.88	6
4090149				Kellerberrin	Doodlakine - Bruce Rock Rd	0	9.68	9.68	4
4090152				Kellerberrin	Kellerberrin - Bencubbin Rd	0	27.64	27.64	6
4090153				Kellerberrin	Scott St	0	0.4	0.4	4
4090154				Kellerberrin	Kellerberrin - Yoting Rd	0	25.07	25.07	4
4140238				Merredin	Doodlakine - Bruce Rock Rd	0	8.64	8.64	4
4140239				Merredin	Merredin - Narembeen Rd	0	36.48	36.48	7
4310103				Wyalkatchem	Railway Tce	0.45	0.73	0.28	5
4310119				Wyalkatchem	Town Access Rd	0	0.18	0.18	4
4310129				Wyalkatchem	Honour Av	0	0.75	0.75	5
4310130				Wyalkatchem	Wyalkatchem - Koorda Rd	0	25.52	25.52	5
4310131				Wyalkatchem	Cunderdin - Wyalkatchem Rd	0	31.23	31.23	4
6110001				Yilgarn	Moorine South Rd	0	68.96	68.96	7
6110041				Yilgarn	Cramphorne Rd	68.96	79.11	10.15	4
6110041				Yilgarn	Cramphorne Rd	0.07	55.17	55.1	7
6110086				Yilgarn	Sth Cross Cbh Wheat Bin Rd	0	0.53	0.53	7
6110123				Yilgarn	Waterbidden Rd	0	11	11	
6110201				Yilgarn	Three Boys Rd	0	2.91	2.91	7
6110226				Yilgarn	Koorda - Bullfinch Rd	0	24.35	24.35	7
4280016				Westonia	Leach Rd	9.48	21.04	11.56	7
4280025				Westonia	Rabbit Proof Fence Rd	0	3.9	3.9	7
4280083				Westonia	Koorda - Bullfinch Rd	0	35.24	35.24	7
4280084				Westonia	Warralakin Rd	7.14	40.02	32.88	7
					Total Length in km			1890.44	

12.3 DEVELOPMENT SERVICES

12.3.1 Proposed Warehouse & Dome Stores – 61 Old York Rd, Northam

Address:	61 Old York Rd, Northam
Owner:	Old York Rd Pty Ltd
Applicant:	Denney Designs
File Reference:	A13136 / P19064
Reporting Officer:	Jacky Jurmann, Manager Planning Services
Responsible Officer:	Chadd Hunt, Executive Manager Development Services
Officer Declaration of Interest:	Nil
Voting Requirement:	Simple Majority
Press release to be issued:	No

BRIEF

An application for development approval has been received to construct a warehouse for the storage and distribution of fasteners used in the construction industry and two dome stores for storage associated with the other approved uses on 61 Old York Rd, Northam.

The application was notified to adjoining landowners and one submission was received regarding the proposal. The issues raised in the submission have been considered in the assessment of this application, which is being recommended for conditional approval.

ATTACHMENTS

- Attachment 1: Submitted Plans.
- Attachment 2: Development Assessment.
- Attachment 3: Submission (Provided as separate confidential attachment to this agenda and minutes).
- Attachment 4: Aerial.

A. BACKGROUND / DETAILS

Council at its Ordinary Meeting held on 15 May 2019 resolved to conditionally approve the construct an office and warehouse building, a dome shelter and install a portable amenities building at 61 Old York Road, Northam. The development is to be used in conjunction with the approved use of the site as a construction yard for modular buildings.

The current application proposes the construction of a warehouse building on the south-west corner of the site behind the modular display area, which will be accessed from the previously approved central driveway. Two dome stores are also proposed for storage associated with the other approved uses on site. However, no plans of the dome stores have been submitted and therefore further details will be required prior to granting final approval.

It is proposed to vary the setback requirement to the western boundary to maximise the use of the site and available vehicle manoeuvring area to ensure that truck movements to and from the site are in a forward direction. A variation to the rear boundary is also proposed in conjunction with the erection of one of the dome shelters. Otherwise, there are no other variations proposed as part of the application.

The property currently comprises multiple lots, being Lots 23 – 37 on P603 and Lot 28155 on P41890, and as a result of the original development proposal spanning lot boundaries, a condition of approval was imposed to require amalgamation of lots to meet planning and building code provisions.

The landowner has commenced the amalgamation process by submitting a subdivision application to the Western Australian Planning Commission for approval. As part of the assessment process, the Shire has provided comments and recommendations in support of the proposal. Taking into consideration that, if the application is approved, the landowner will have 3 years to complete the amalgamation, the standard condition requiring amalgamation within 12 months of approval or prior to occupation (whichever occurs first) should again be imposed.

B. CONSIDERATIONS

B.1 Strategic Community Plan

Theme Area 1: Economic Growth

Outcome 1.1: The Shire of Northam is an attractive investment destination for a variety of economic sectors.

Objective: Ensure the Shire of Northam is a welcoming and easy place for quality investment to occur.

Shire of Northam Local Planning Strategy

Section 3.2: Commerce & Industry

Vision/Objective: Development of a diversified range of commerce and industry in appropriate locations which provides significant employment opportunities and reduces the local economy's dependency upon the agricultural sector.

Strategy: Promote diversification of the Shire's economy and the creation of new employment opportunities by

encouraging the development of a wide range of new commercial and industrial uses.

B.2 Financial / Resource Implications

The relevant application fee has been paid on application by the Applicant.

B.3 Legislative Compliance

The subject property is zoned Light and Service Industry under the provisions of the Shire of Northam Local Planning Scheme No. 6 with the use of the property as a construction yard for modular buildings (Industry – Light) was approved under delegated authority on 28 February 2018 (Ref. P17117).

As indicated in the Background section of this Report, Council approved a development application (Ref: P18018) for the construction of an office and warehouse at its Ordinary Meeting held on 15 May 2019, subject to a number of conditions.

The application was submitted to the Shire on 9 August 2019 seeking approval to construct a warehouse for the storage and distribution of fasteners used in the construction industry. The building will have an area of 1,339.71m² and will include an office to be used in conjunction with the proposed use as depicted on the submitted plans (**Attachment 1**).

The proposed use is best described as Industry – Light, which is a permitted use in the zone providing the use complies with the relevant development standards and the requirements of the Scheme.

An assessment of the development proposal is attached to this Report (**Attachment 2**), which shows that the development complies with the provisions of the Scheme, with the exception of the western setback and the setbacks of buildings to individual lot boundaries.

Clause 4.5 – Site and Development Standards and Requirements

- Table 2: Setbacks – 7.5m front and rear; 4m sides; Landscaping – 10% of site area; Minimum lot size – 1,000m².
- Proposed:
- The individual lots vary in width from 20.12m to 24.54m and are 50.29m deep, and includes a portion of closed road reserve that is 20.12m wide). As indicated in this Report, amalgamation of the lots has commenced.
- If the setbacks are assessed as a single lot, the western side setback proposed for the warehouse does not comply, and the rear and side setbacks proposed for the dome shelter 1 do not comply.
- Landscaping is proposed in conjunction with the previous development approval. Due to the area on the original plan not equating to 10% of

the site area, and a condition of approval was imposed, and should be reiterated on this approval.

- The minimum lot size requirements will be met following amalgamation.

B.4 Policy Implications

The WA Government Sewerage Policy came into effect on 25 September 2019, which recommends a separation distance of 100m between watercourses and on-site sewerage systems. The development plans previously approved by Council (P18108) indicated that an alternative treatment unit would be installed to manage sewerage on-site and that the irrigation area would be located behind the main building. Due to the introduction of this policy, further investigation may be required to determine if secondary treatment may be required depending on the results of the site and soil evaluation. Noting that the system would be the subject of a Department of Health approval and further consultation with the Department of Water and Environmental Regulation.

B.5 Stakeholder Engagement / Consultation

Due to the proposed variation of the side and rear setbacks, consultation with the adjoining landowners was deemed appropriate. One submission from the landowner at 59 Old York Road raising concerns regarding the loss of privacy, impacts of dust and stormwater, filling of the site and visual intrusion as a result of the setback variation and proposed chain link fencing indicated on the plans. A copy of the submission is attached to this Report (**Attachment 3**).

To address these concerns, conditions have been imposed requiring the installation of solid fencing along the subject boundary for the distance adjoining the submitter's property, and submission of landscaping and drainage plans.

B.6 Risk Implications

Risk Category	Description	Rating (consequence x likelihood)	Mitigation Action
Financial	Application fee paid. Legal implications.	Low (2)	Fee paid. Conditions have a nexus to proposal.
Health & Safety	Design of building to comply with BCA	Low (4)	Nil
Reputation	Consideration of submission	Low (4)	Nil
Service Interruption	Application assessed in timely manner	Low (1)	Nil
Compliance	Appropriate conditions imposed	Low (4)	Ensure compliance

Property	LPS can permit development	Low (4)	Conditions imposed to address identified issues.
Environment	Impacts on flooding	Low (4)	Conditions imposed regarding potential impacts on dome shelters in flood area.

C. OFFICER'S COMMENT

As indicated in this Report, the proposed variation to the setback provisions of LPS6 and the issues raised in the submission are the main issues for consideration when determining this application.

The setback variations associated with the current multiple lots will be negated following completion of the amalgamation process to form a single lot. The setback variations proposed for the new warehouse building and the dome shelter located in the north-western corner of the property, are considered acceptable for the following reasons:

- Warehouse – variation of the western side setback will enable the landowner to maximise and provide improved vehicle access to and within the site. The proposed orientation of the building results in the rear of the building facing the neighbouring property resulting in no windows or openings being proposed on this elevation and therefore minimising any impacts associated with the use of the building.
- Dome Shelters – no details of the proposed dome shelters have been provided with the application. Typically dome shelters are open structures either attached directly to the ground or to sea containers. Additional details are required prior to granting final approval for this part of the development proposal. The proposed location of the dome shelter in the north-western corner of the site, resulting in side and rear setback variations, does not impact on any neighbouring properties, however the location is within the flood prone area and therefore the final plans will require referral to the Department of Water and Environmental Regulation.

RECOMMENDATION / COUNCIL DECISION

Minute No: C.3784

Moved: Cr Mencshelyi

Seconded: Cr Della

That Council approve the development application reference P19064 to construct a warehouse building and two (2) dome shelters on Lots 23 – 37 on

P603 and Lot 28155 on P41890 known as 61 Old York Road, Northam and accompanying plans:

- Overall Site Plan, Drawing No. A101 (Rev. A);
- Part Site Plan, Drawing No. 102 (Rev. A);
- Warehouse Floor Plan, Drawing No. 200 (Rev. A);
- Warehouse Elevations, Drawing No. A300 (Rev. A);

in accordance with Clause 68 of the Planning and Development (Local Planning Schemes) Regulations 2015 and the provisions of the Shire of Northam Local Planning Scheme No. 6, subject to the following conditions:

General

1. The development hereby permitted shall substantially commence within two (2) years from the date of determination.

Conditions to be met prior to the commencement of development

2. Prior to the commencement of any development, a detailed drainage design shall be submitted to the local government for approval, prescribing a functional drainage system, including detailed engineering drawings, and necessary technical information to demonstrate functionality of the design.
3. Prior to commencement of development, a detailed Landscaping Plan, including details of screening of outdoor storage areas, shall be submitted to local government for approval.
4. Prior to commencement of development, full details of the dome shelters, including construction and materials, shall be submitted to the local government for approval.

Conditions to be met prior to occupation of development

5. Prior to the occupation of the development, Lots 23 – 37 on P603 and Lot 28155 on P41890 Old York Road are to be amalgamated into one Certificate of Title.
6. Prior to the occupation of development, solid acoustic fencing shall be erected on the western boundary, including any required retaining, from the front building setback to the rear boundary of Lot 5 (59) Old York Road, Northam.
7. Prior to the occupation, the development shall be connected to an approval effluent disposal system.
8. Prior to the occupation of the development, the landscaping and irrigation of the development site shall be installed in accordance with the approved landscape plan.
9. Prior to the occupation of the development, the proposed hardstand area is to be paved, sealed and drained to the satisfaction of the local government.
10. Prior to occupation of the development, vehicle parking, manoeuvring and circulation areas shall be designed, constructed, sealed, drained, line-marked and kerbed in accordance with:

- (i) The approved plan(s);
 - (ii) Australian/New Zealand Standard AS/NZS 2890.1:2004, Parking facilities, Part 1: Off-street car parking;
 - (iii) Australian/New Zealand Standard AS/NZS 2890.6:2009, Parking facilities, Part 6: Off-street parking for people with disabilities;
 - (iv) Australian Standard AS 1428.1-2009, Design for access and mobility, Part 1: General Requirements for access – New building work (by providing a link to the main entrance of the development by a continuous accessible path of travel);
 - (v) Council's engineering requirements and design guidelines.
11. Prior to the occupation, the development shall be connected to an approved on-site sewerage system.

Conditions requiring ongoing compliance

- 12. The drainage system is to be maintained to the satisfaction of the local government.
- 13. The car parking is to be maintained to the satisfaction of the local government.
- 14. The landscaping is to be maintained to the satisfaction of the local government.

CARRIED 6/0

Clarification was sought in relation to whether the recommendation is sufficiently in line with the notes regarding the onsite sewerage. The Executive Manager Development Services confirmed that there is no reticulated sewer and an onsite effluent disposal system is required. There is a pre-existing approval for the site which also has a condition imposed as part of that approval which relates to the sewerage.

Attachment 1

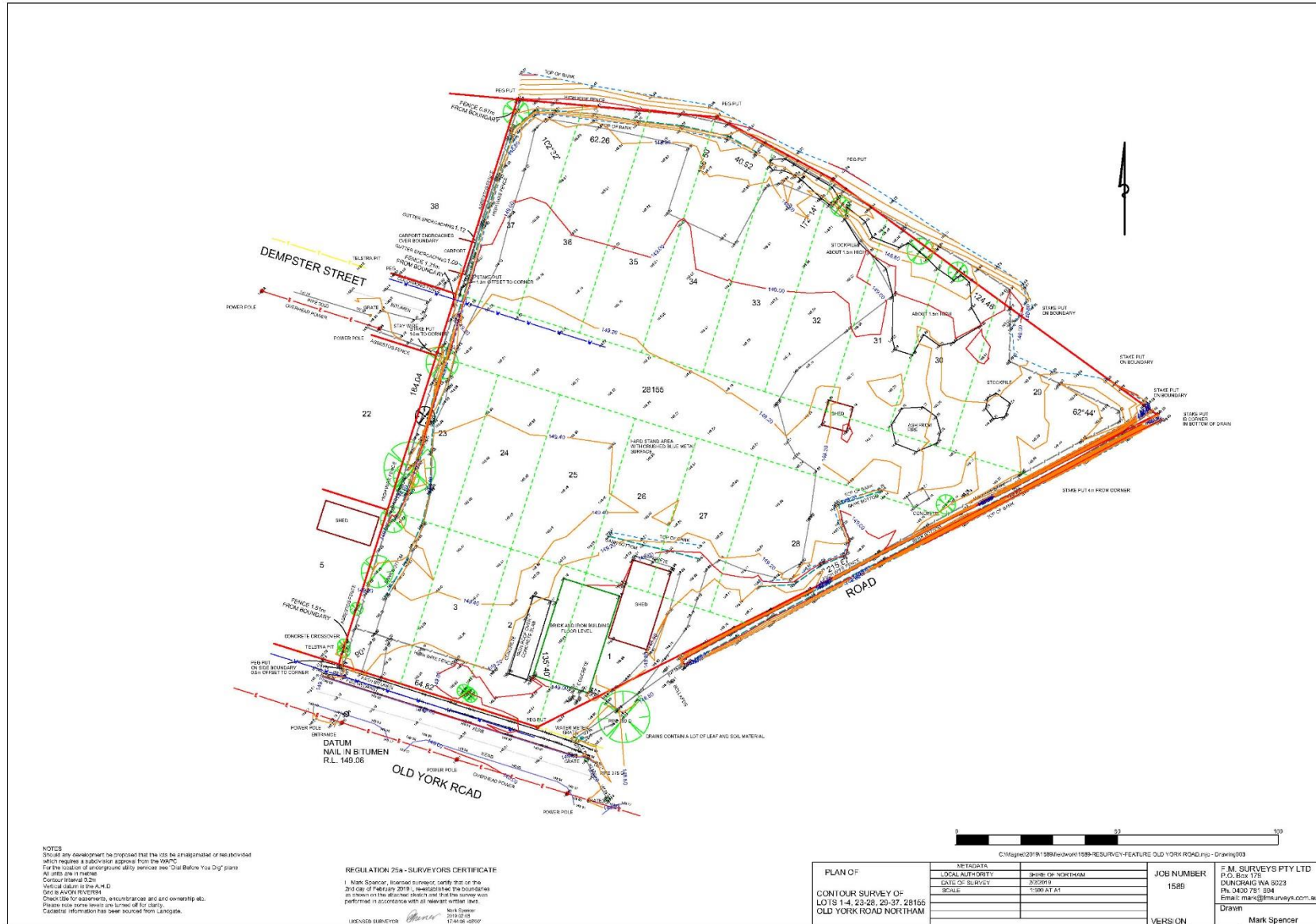

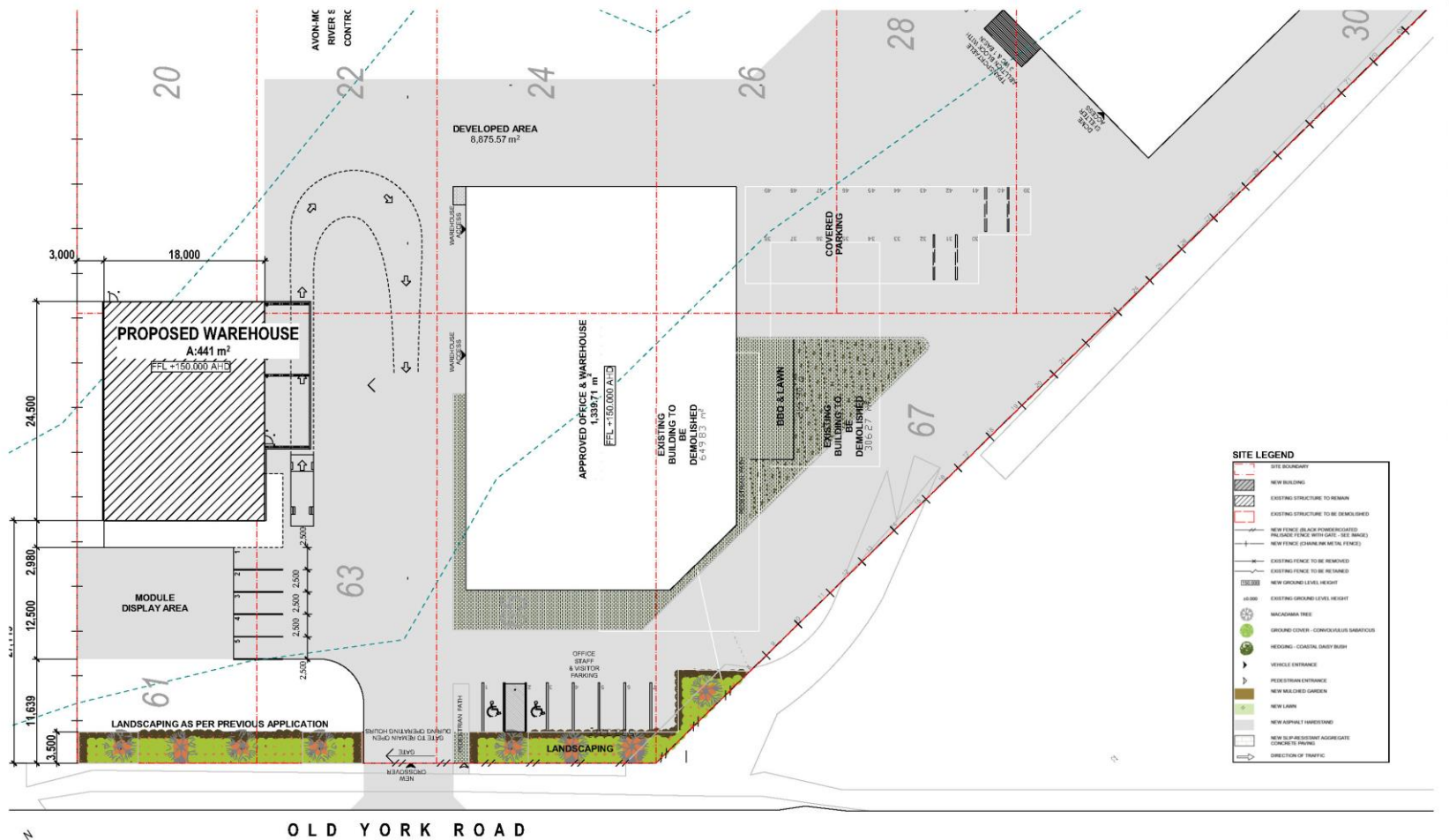

PART SITE PLAN
 Scale 1:200

denney building Design
 www.denneydesign.com denneydesign@hotmail.com.au (+61) 0418 208 320

AKRON
 Develop • Design • Build
 Formerly WBS Commercial

WAREHOUSE
 SHIRE OF NORTHAM
 PART SITE PLAN
 01 OLD YORK ROAD
 NORTHAM - WESTERN AUSTRALIA

1. ALL LEVEL DIMENSIONS, POSITIONS & HEIGHTS TO BE CHECKED & VERIFIED ON SITE BEFORE COMMENCEMENT OF BUILDING WORKS.
2. FIGURED DIMENSIONS ARE TO BE TAKEN ON NET SCALE OF DRAWINGS.
3. ALL STRUCTURE DIMENSIONS TO BE MADE IN CONFORMANCE WITH ALL APPLICABLE CODES & ALL OTHER AS/ NZS STANDARDS PERTAINING TO STRUCTURAL, ELECTRICAL, MECHANICAL & PLUMBING.
4. ANY DISCREPANCIES TO BE REPORTED TO THE AUTHOR BEFORE CONSTRUCTION IS STARTED.
5. REFER TO STRUCTURAL ENGINEERS DRAWINGS FOR ALL STRUCTURAL WORKING.
6. LARGE SCALE DRAWINGS TO SUPPLEMENT SMALL SCALE DRAWINGS.

NO.	REV.	DATE	BY	CHK.	DESCRIPTION
1	01	15/01/2019			

DESIGNER	DATE	SCALE
511	02/07/2019	1:200
A 102		
A		

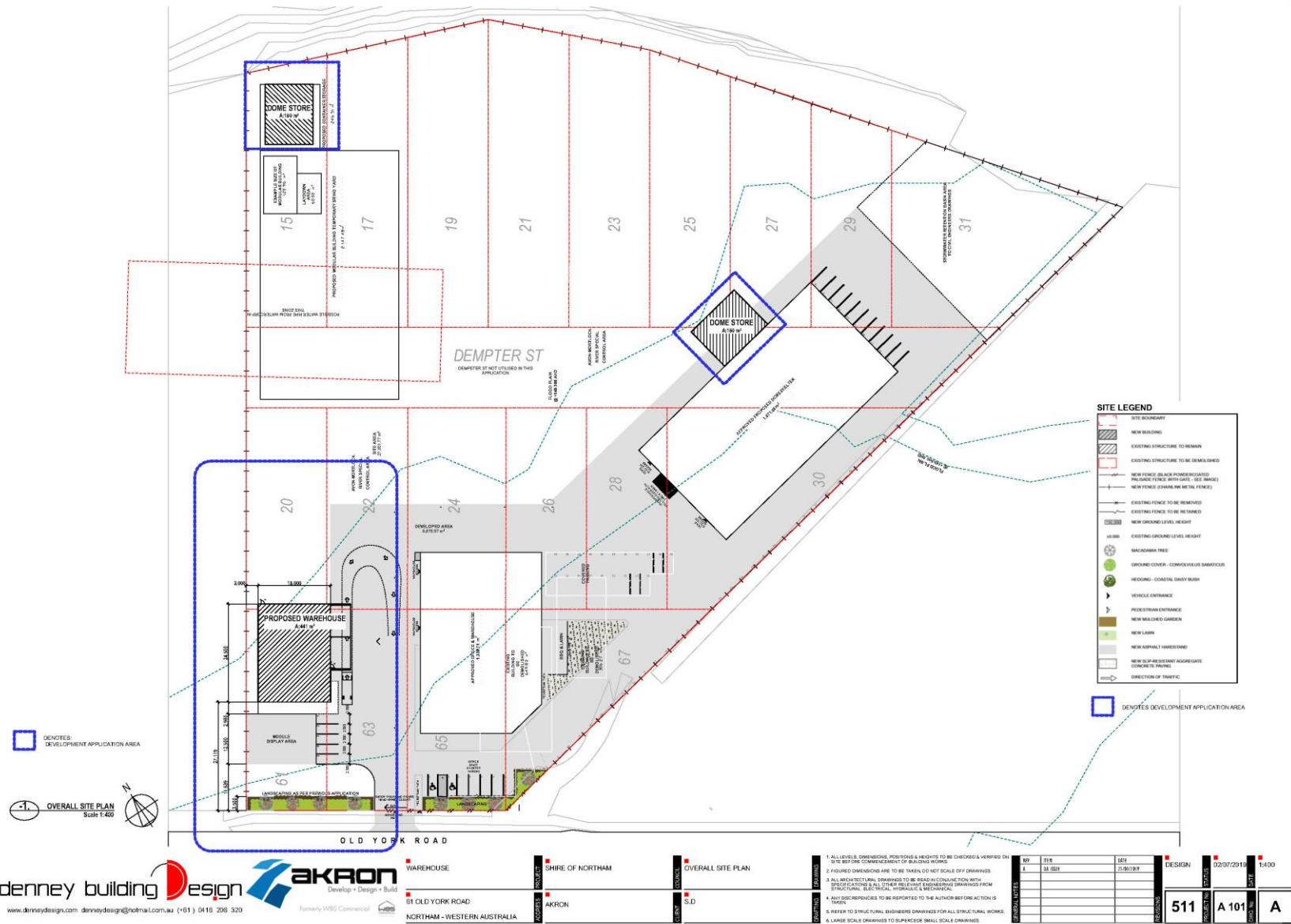

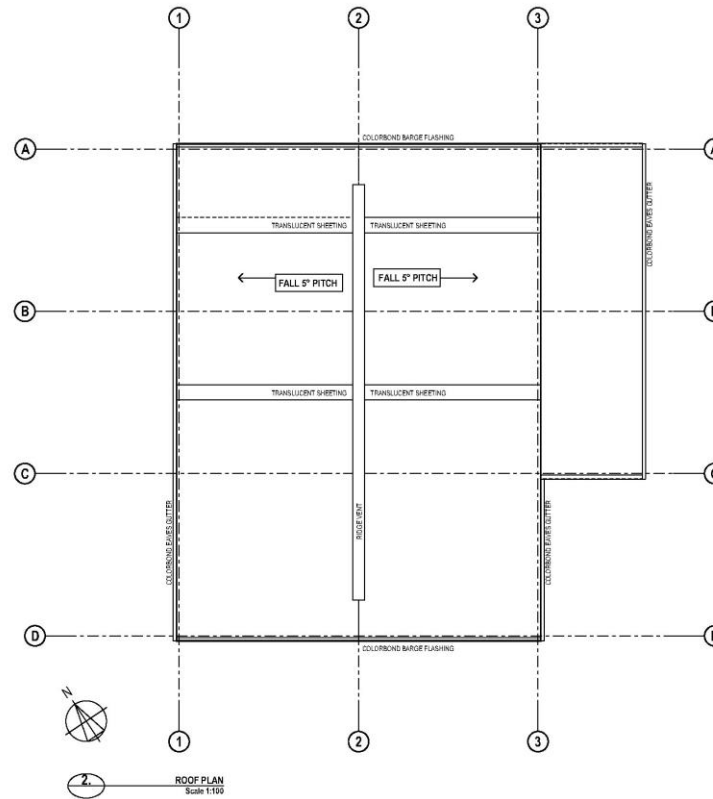
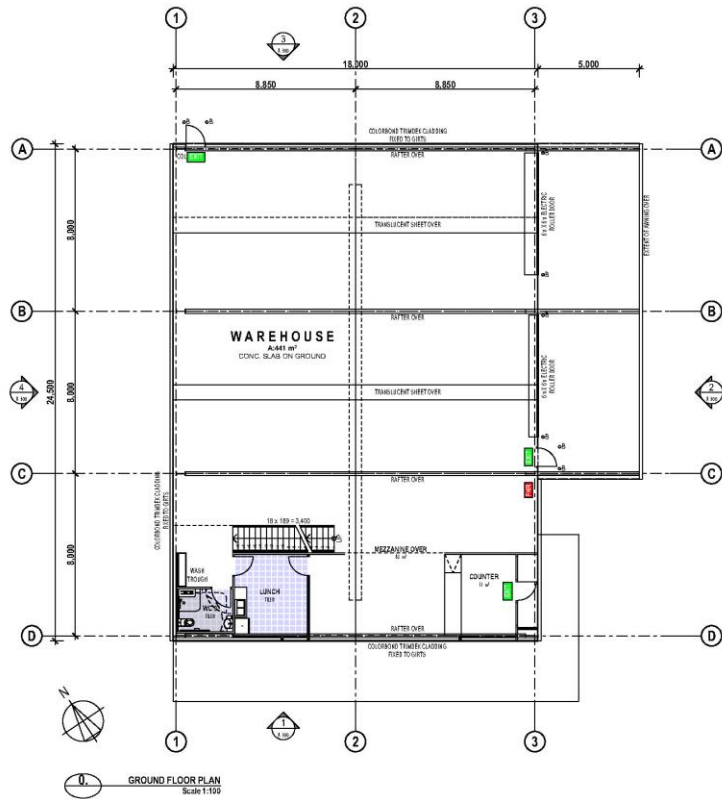

denney building **Design**
 www.denneydesign.com denneydesign@hotmail.com.au (+61) 0418 208 320

AKRON
 Develop • Design • Build
 Formerly WBS Commercial

WAREHOUSE
 01 OLD YORK ROAD
 NORTHAM - WESTERN AUSTRALIA

PROJECT: SHIRE OF NORTHAM
 CLIENT: AKRON
 CONSULTANT: S.I.D.

1. ALL LEVELS, DIMENSIONS, POSITIONS & HEIGHTS TO BE CHECKED & VERIFIED ON SITE BEFORE COMMENCEMENT OF BUILDING WORKS.
2. FIGURED DIMENSIONS ARE TO BE TAKEN ON NET SCALE OF DRAWINGS.
3. ALL STRUCTURE DRAWINGS TO BE MADE IN CONFORMANCE WITH ALL APPLICABLE CODES & ALL OTHER AS/NZS REFERRED TO IN THE DRAWINGS FROM SPECIFICATIONS, TECHNICAL PROVISIONS & REVISIONS.
4. ANY DISCREPANCIES TO BE REPORTED TO THE AUTHOR BEFORE ACTION IS TAKEN.
5. REFER TO STRUCTURAL ENGINEERS DRAWINGS FOR ALL STRUCTURAL WORKS.
6. LARGE SCALE DRAWINGS TO SUPPLEMENT SMALL SCALE DRAWINGS.

NO.	REV.	DATE	BY	CHK.	APP.	DESCRIPTION
1	01	21/01/2019				DESIGN

DATE: 02/07/2019
 TIME: 11:00

511 A 200 A

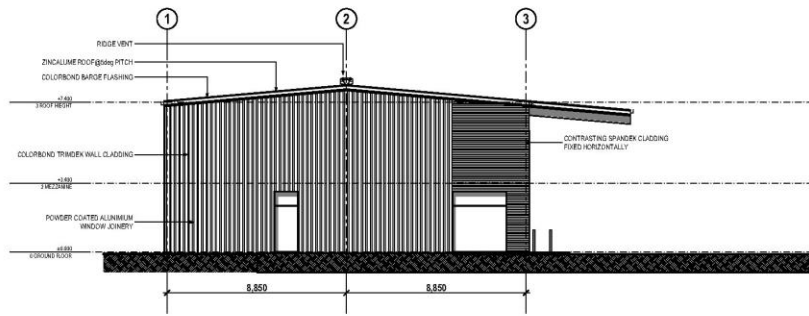

1 SOUTH ELEVATION
Scale 1:100

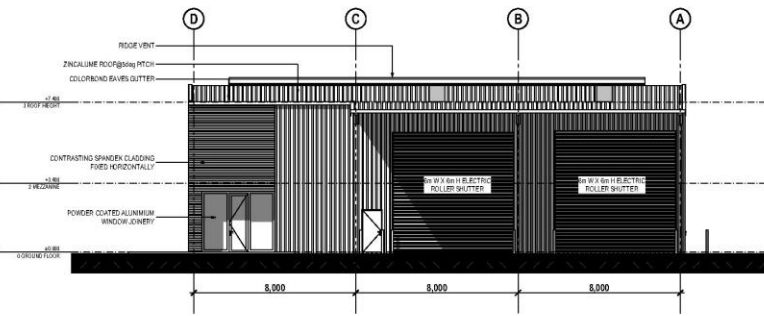

2 EAST ELEVATION
Scale 1:100

KEY	MATERIAL	COLOUR	APPLICATION
1	TRIMDEK	SURFMIST	VERTICAL
2	ROLLER DOOR	SURFMIST	N/A
3	SPANDER	BASALT	HORIZONTAL
4	DULUX	HARDENED STEEL	PAINTED
5	DULUX	SURFMIST	PAINTED
6	DULUX	MATT BLACK	POWDER COATED
7	CONCRETE	WASHED AGGREGATE	N/A

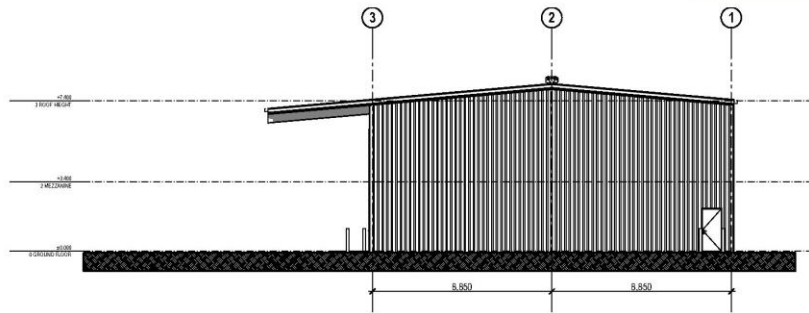
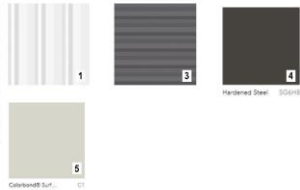

3 NORTH ELEVATION
Scale 1:100

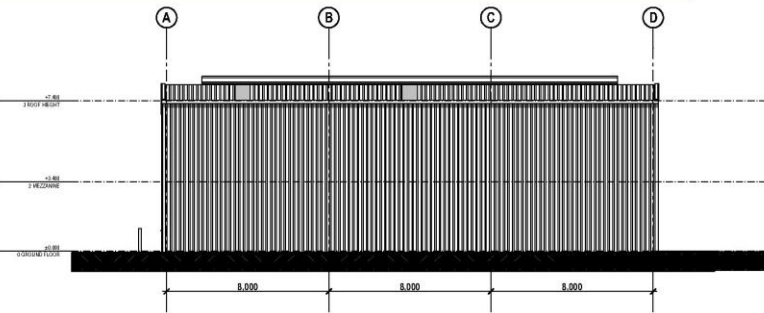

4 WEST ELEVATION
Scale 1:100

denney building design
www.denneydesign.com denneydesign@hotmail.com.au (+61) 0418 208 320

AKRON
Develop • Design • Build
Formerly WBS Commercial

WAREHOUSE
SHIRE OF NORTHAM
01 OLD YORK ROAD
NORTHAM - WESTERN AUSTRALIA

PROJECT
AKRON
CLIENT
S.I.D.

ELEVATIONS

1. ALL LEVELS, DIMENSIONS, POSITIONS & HEIGHTS TO BE CHECKED & VERIFIED ON SITE BEFORE COMMENCEMENT OF BUILDING WORKS.
2. DIMENSIONS ARE TO BE TAKEN TO THE FACE UNLESS OTHERWISE SPECIFIED.
3. ALL DIMENSIONS TO BE TAKEN TO THE FACE UNLESS OTHERWISE SPECIFIED.
4. ANY DISCREPANCIES TO BE REPORTED TO THE AUTHOR BEFORE ACTION IS TAKEN.
5. REFER TO STRUCTURAL ENGINEERS DRAWINGS FOR ALL STRUCTURAL WORKS.
6. LARGE SCALE DRAWINGS TO SUPPLEMENT SMALL SCALE DRAWINGS.

REV	DATE	BY	CHK	DESCRIPTION
1	08/08/18	JL	JK	ISSUED FOR PERMIT

DESIGN	02/07/2018	1:100
511	A 300	A

Attachment 2

PLANNING ASSESSMENT – DA P19064 61 OLD YORK ROAD, NORTHAM

Table 1 – Planning Assessment

Scheme/Policy Provision	Officer Assessment
<p><u>LPS6 – 4.5 Site and Development Requirements</u></p> <ul style="list-style-type: none"> • Setbacks – 7.5m front and rear; 4m sides; • Landscaping – 10% of site area. 	<ul style="list-style-type: none"> • Setbacks – Warehouse: 27.119m front (Old York Rd); >7.5m rear; >4m (east) and 3m side (west) if assessed as a consolidated lot; dome stores – 1 (north-western corner): >7.5m front; 3m rear; >3m side (east) and 3m side (west); and 2 (central): setbacks comply. • Landscaping is proposed in conjunction with the previous development approval. Due to the area on the original plan not equating to 10% of the site area, and a condition of approval was imposed, and should be reiterated on this approval.
<p><u>LPS6 – 4.8 Outdoor Storage Areas</u></p> <ul style="list-style-type: none"> • Open air displays, storage, lay-down areas, etc to be sealed, paved and/or landscaped. • Areas to be screened where it is likely to detract from the visual amenity. 	<ul style="list-style-type: none"> • Current operation involves outdoor storage. • New buildings will reduce outdoor storage. • Any outdoor storage to be screened. • Landscaping plan required and shall include screening of outdoor areas.
<p><u>LPS6 - 4.10 Maximum Building Height</u></p> <ul style="list-style-type: none"> • No more than two storeys or exceed 9 metres in height measured to the highest proportion of the building. 	<ul style="list-style-type: none"> • Proposed: Wall height – 7.4m; overall height – 7.6m.
<p><u>LPS6 – 4.12 Landscaping</u></p> <ul style="list-style-type: none"> • Development approval may be required to be accompanied by landscaping plans. • Prior to the occupation, landscaping is to be planted and maintained. 	<ul style="list-style-type: none"> • Table 2 requires 10% of the site to be landscaped. • Nominal landscaping has been identified on the submitted plans. • Recommend condition requiring submission of detailed landscaping plans, including screening, to ensure compliance.
<p><u>LPS6 4.13 – Car Parking</u></p> <ul style="list-style-type: none"> • Car parking to be provided in accordance with Table 3. • Spaces to comply with Australian Standards. • Open car parking facilities with 20 or more parking spaces – one space for every 20 to be for planting of native plants and trees to provide visual relief. 	<p>Proposed car parking complies with the provisions of LPS6. Refer to Table 2 – Car Parking Assessment of this attachment.</p>

Scheme/Policy Provision	Officer Assessment
<ul style="list-style-type: none"> • Local government shall have regard to: <ul style="list-style-type: none"> a) the location and design; b) natural planting; c) pedestrian spaces; and d) any other relevant matter. 	
<p><u>LPS6 4.14 – Traffic Entrances</u></p> <ul style="list-style-type: none"> • Local government may: <ul style="list-style-type: none"> ○ not permit more than one vehicle entrance or exit to or from any lot; ○ require separate entrances and exits; or ○ require that entrances and exits be placed in appropriate positions. 	<ul style="list-style-type: none"> • One access and egress to be provided. • Crossover to be constructed in conjunction with original development proposal.
<p><u>LPS6 4.16 – Access for Loading and Unloading Vehicles</u></p> <ul style="list-style-type: none"> • Provision to be made for the purpose of loading or unloading goods or materials; • Servicing vehicles to be able to enter the street in a forward direction. 	<ul style="list-style-type: none"> • Site plans show appropriate loading and unloading areas of materials. • Layout of development, including side setback variation, enables vehicles enter and leave the premise in a forward gear.
<p><u>LPS6 4.28 – Development in the General Industry and Light and Service Industry Zones</u></p> <ul style="list-style-type: none"> • Where a reticulated sewerage system is not available approval may be granted which permits on-site effluent disposal where sit conditions are suitable. • Minimum standard fence – minimum of 1.8m high to a maximum of 2.4m high link mesh fence. • Development is to be set back from property boundaries and roads to minimise amenity impacts of industrial land use on adjacent land. 	<ul style="list-style-type: none"> • Alternative Treatment Unit proposed to manage wastewater as part of original development proposal. • Applicant proposes to erect new chain link fencing on boundary. Objection received regarding this type of fencing. Condition imposed to reduce impacts. • Setbacks to front boundary comply with LPS6 standards.
<p><u>DP 67(a)</u> – the aims and provisions of this Scheme;</p>	<p>The proposal is consistent with the aims and generally with the provisions of LPS6 as demonstrated in this assessment.</p>
<p><u>DP 67(g)</u> – any local planning policy for the Scheme area;</p>	
<p><u>DP 67(k)</u> – the built heritage conservation of any place that is of cultural significance;</p>	<p>No impacts associated with this proposed. Refer to original assessment regarding demolition of previous sale yards buildings.</p>
<p><u>DP67(m)</u> – the compatibility of the development with its setting including the likely effect of the height, bulk, scale, orientation and appearance;</p>	<p>The new development is considered compatible with the future vision for development of the site and locality.</p>
<p><u>DP67(n)</u> – the amenity of the locality, including environmental impacts; character; and social impacts;</p>	<p>Concerns regarding amenity impacts were raised in the submission and have been addressed through conditions regarding fencing.</p>
<p><u>DP67(o)</u> – the likely effect on the natural environment or water resources;</p>	<p>No impacts identified. Dome shelter details may be referred to DWER.</p>

Scheme/Policy Provision	Officer Assessment
DP67(p) – whether adequate provision has been made for the landscaping;	Further landscaping details are required as indicated earlier in this assessment.
DP67(q) – suitability of the land taking into account the possible risk of flooding, bush fire, or any other risk;	The Department of Water and Environmental Regulation have advised that the development of the site will not affect major flooding (note comments regarding dome shelter). A Bushfire Report has been previously submitted and approved for the site as part of the original change of use application.
DP67(s) – the adequacy of access to and egress from the site; and arrangements for the loading, unloading, manoeuvring and parking of vehicles;	Satisfactory. Refer to previous comments earlier in this assessment.
DP67(t) – the amount of traffic likely to be generated by the development and effects on traffic flow and safety;	The Shire's Engineering section assessed the original proposal and recommended that all traffic enter and exit in a forward direction. The land use has been approved under a previous application.
DP67(u) – the adequacy storage, management and collection of waste; access by older people and people with disability;	The Shire's EHO has recommended that waste storage areas be screened. Access for disabled persons will be required under the Building Code of Australia and assessed as part of the Building Permit process.
DP67(w) – the history of the site where the development is to be located;	The site historically was used as a livestock saleyard.
DP67(y) – any submissions received on the application;	One submission was received raising concerns regarding the development. Issues raised have been considered in the assessment of the application.
(za) the comments or submissions received from any authority consulted under clause 66;	The Department of Water and Environment Regulation were consulted during the assessment of the original application.

Table 2 – Car Parking Calculations

Parking Calculation	Bay Calculation	Area Proposed	Bays Required
Bays Required as part of original development:			72
Warehouse	1/100m GFA	441m ²	4.41
New Ancillary Office	1/25m NLA	11m ²	0.47
New Bays Required:			5
New Bays Proposed:			5

Cr J E G Williams declared an "Impartiality" interest in item 12.3.2 - Proposed Local Planning Policy No. 25 – Spencers Brook Special Control Area as the submitter requesting his property be removed from the SCA is well known to her through membership of the Spencers Brook Progress Association. Impartiality only, matter was discussed at Progress.

12.3.2 Proposed Local Planning Policy No. 25 – Spencers Brook Special Control Area

Address:	SCA3 – Spencers Brook Special Control Area
Owner:	Various
Applicant:	Shire of Northam
File Reference:	2.3.1.2
Reporting Officer:	Jacky Jurmann, Manager Planning Services
Responsible Officer:	Chadd Hunt, Executive Manager Development Services
Officer Declaration of Interest:	Nil
Voting Requirement:	Simple Majority
Press release to be issued:	No

BRIEF

Council at its Ordinary Meeting held on 19th June 2019, resolved to adopt the draft Local Planning Policy No. 25 – Spencers Brook Special Control Area for advertising purposes.

The draft policy was advertised in accordance with Council's resolution and seven (7) submissions were received from or on behalf of landowners and from the Department of Water and Environmental Regulation, which have been considered in the finalisation of the policy.

The modified policy (**Attachment 1**) is now presented to Council for final adoption in accordance with the provisions of the *Planning and Development (Local Planning Schemes) Regulations 2015* (Deemed Provisions).

ATTACHMENTS

- Attachment 1: Local Planning Policy No. 25.
Attachment 2: Schedule of Submissions (full copies of submissions provided to Council separately).

A. BACKGROUND / DETAILS

Council considered this matter and background at its Ordinary Meeting held on 19th June 2019.

As indicated in the previous report, the purpose of the local planning policy is to provide guidance to landowners and development of lots located in the Spencers Brook Special Control Area (SCA3) taking into consideration the significant site constraints of the area, in particular impacts of flooding.

B. CONSIDERATIONS

B.1 Local Planning Strategy

Key Actions in the LPS in regards to the locality and issue are to:

- Incorporate 'Special Control Area' provisions in Local Planning Scheme No.6 specific to the Spencers Brook locality and apply the provisions accordingly to ensure that any future development and use of land within the locality is appropriately located, preserves the ecological values of Spencers Brook and the nearby Avon River and associated riparian zones and does not adversely alter the capacity of these local floodways to convey floodwaters or give rise to any further land degradation.
- Ensure that any future development in the Spencers Brook locality has due regard for the potential flood risk and does not compromise the ecological values of the Avon River and associated riparian zone or adversely alter the capacity of the local floodway to convey floodwaters.
- Preservation of vistas on Roads and Highways including Great Eastern Highway along its full length, Great Southern Highway along its full length, Northam-Pithara Road, Northam-Toodyay Road, Northam-Cranbrook Road, Eadine Road (Kep Track), Clackline-Toodyay Road, Spencers Brook-York Road, Inkpen Road and Irishtown Road. Tourist routes including Katrine Road and Spencers Brook Road.

B.2 Financial / Resource Implications

The proposed LPP will provide guidance for the sustainable development of the area for Council and Applicants, thereby reducing financial risks and resources relating to the application process and future appeals.

B.3 Legislative Compliance

The proposed LPP has been drafted and advertised in accordance with the requirements of the *Planning and Development (Local Planning Schemes) Regulations 2015*.

B.4 Policy Implications

The proposed LPP will provide an improved regulatory framework for development in the Spencers Brook SCA.

Since the adoption and advertising of the draft LPP, the WA Government Sewerage Policy (2019) became operational on 23 September 2019, and as a result additional provisions have been included in the LPP regarding separation distances from waterways and groundwater for on-site sewerage systems, together with an amendment to the Development Plan depicting the 100 metre recommended setback distance from the waterway. A copy of the Policy has been provided separately to Council for their information.

B.5 Stakeholder Engagement / Consultation

The draft policy was advertised in accordance with the provisions of the *Planning and Development (Local Planning Schemes) Regulations 2015* for a minimum period of 21 days. Advertising including landowner notification in writing; and advertisements in the Avon Advocate and on the Shire's website.

A total of seven (7) submissions were received. Six (6) from or on behalf of landowners and one from the Department of Water and Environmental Regulation.

The issues raised in the submissions have been considered in the finalisation of the draft policy, and where appropriate modifications have been made.

A Schedule of Submissions is attached to this Report (**Attachment 2**) and full copies of the submissions have been provided to Council separately.

B.6 Risk Implications

Risk Category	Description	Rating (consequence x likelihood)	Mitigation Action
Financial	Advertising costs associated with development of LPPs is within the existing budget.	Low (1)	N/a
Health & Safety	LPP provides framework for appropriate development.	Low (4)	Implement LPP consistently.
Reputation	LPP to be adopted in accordance with legislative requirements.	Low (4)	Implement LPP consistently.
Service Interruption	LPP provides framework for timely approvals.	Low (4)	Implement LPP consistently.
Compliance	LPP to be adopted in accordance with legislative requirements.	Low (1)	N/a
Property	LPP provides framework for appropriate development.	Low (4)	Implement LPP consistently.

Environment	Mitigate flooding impacts future on development.	Moderate (6)	Implement LPP consistently.
-------------	--	--------------	-----------------------------

C. OFFICER'S COMMENT

The Local Planning Policy will apply to the whole of the Spencers Brook Special Control Area.

Discussions and submissions from the landowners and the Department of Water and Environmental Regulation have indicated that they were generally supportive of the introduction of a policy to provide guidance in the area, subject to the issues raised being further considered.

Accordingly, the following actions are recommended:

- Modification to the LPP text – a number of modifications made to the text of the policy taking into consideration the issues raised in the submissions, and in particular, the recommendations contained in the response from the Department of Water and Environmental Regulation and Altus Planning.
 As indicated in the Policy Implications section of this Report, modifications to the text also include provisions to reflect the introduction of the WA Government Sewerage Policy (2019).
- Identification of recommended separation distance for on-site sewerage systems – the 100 metre waterway separation distance for on-site sewerage systems as recommended in the WA Government Sewerage Policy (2019) has been identified on the Development Plan (in addition to the text amendments).
- Review of the lots identified for potential amalgamation – in the draft advertised policy the lots identified for potential amalgamation have been reviewed taking into consideration the issues raised in the submissions resulting in the mapping being modified where it was deemed appropriate to achieve the objectives of the policy, particularly on those lots where it is necessary to provide a sufficient area outside the flood area to construct a dwelling, associated facilities and ancillary structures.
- Modification to the Special Control Area (SCA) – the owner of Lot 100 in his submission has requested that his property be removed from the SCA, and therefore from the provisions of the policy, taking into consideration that the majority of his property is located outside the flood affected area. It is recommended that the landowner's request be partially supported, which would result in the majority of his property being excluded from the policy area (as depicted on the Development Plan in Appendix 1 of the Policy). In regards to being removed from the SCA, this request will be considered in the upcoming review of the local planning scheme.

- Closure of Cowan Street – in addition to the adoption of the policy, it is proposed to initiate the closure of Cowan Street, an unmade road reserve situated between Lots 8 and 9. The closure of this road would facilitate the creation of a single lot that could be development in accordance with the provisions of the policy following its amalgamation with Lots 1 to 16 as depicted in the Development Plan (Appendix 1 of the policy).
- Drainage from the rail reserve – drainage from the rail reserve and effects on nearby properties was another issue raised in the submissions. To address this issue, it is recommended that consultation is commenced with the Public Transport Authority (PTA) to improve management of the drainage in the locality, particularly if there is a need for an easement in conjunction with the closure of Cowan Street.

In conclusion, the modified policy, including amendments to reflect the introduction of the WA Government Sewerage Policy; closure of Cowan Street; and consultation with the PTA will result in better development and regulation of the Spencers Brook Special Control Area.

RECOMMENDATION / COUNCIL DECISION

Minute No: C.3785

Moved: Cr Little

Seconded: Cr Ryan

That Council:

- 1. Adopts Local Planning Policy No. 25 – Spencers Brook Special Control Area as modified and attached to this Report (Attachment 1);**
- 2. Advertise the adoption of Local Planning Policy No. 25 – Spencers Brook Special Control Area in accordance with the provisions of the *Planning and Development (Local Planning Schemes) Regulations 2015*;**
- 3. Commence the processes to formally close Cowan Street, Spencers Brook for amalgamation into an adjoining lot in accordance with the provisions of the *Land Administration Act 1997*;**
- 4. Commence discussions with the Public Transport Authority to improve the management of drainage from the rail reserve.**

CARRIED 6/0

Clarification was sought in relation to whether the map was updated to remove number 21 from the amalgamation. The Executive Manager Development Services confirmed this has been updated.

Attachment 1

Local Planning Policy No. 25 – Spencers Brook Special Control Area (SCA3)

1. Preliminary

This local planning policy has been prepared to provide guidance to landowners and developers of lots located in the Spencers Brook Special Control Area (SCA3) taking into consideration the significant site constraints of the area.

1.1 Authority to prepare and adopt a Local Planning Policy

Schedule 2, Part 2, clause 3(1) of the *Planning and Development (Local Planning Schemes) Regulations 2015* (the Regulations) allows Council to prepare a Local Planning Policy in respect of any matter related to the planning and development of the Shire's Local Planning Scheme No.6 (the Scheme) area.

This policy will be made effective once Council has completed the process stipulated in clause 4(1) up to and including clause 4(4) of the Regulations.

1.2 Relationship of this Policy to the Scheme

If a provision of this Policy is inconsistent with the Scheme, the Scheme prevails.

This Local Planning Policy is not part of the Scheme and does not bind Council in respect of any application for development approval. However, Council shall have due regard to the provisions of the Policy and the objectives which the Policy is designed to achieve before making its determination.

2. Application of the Policy

2.1 Definitions

“**R-Codes**” means State Planning Policy 7.3 – Residential Design Codes.

2.2 Application

This Policy applies to the Spencers Brook Special Control Area as identified in the Shire of Northam's Local Planning Scheme No. 6, known as SCA.

3. Policy Objectives

The purpose of this Policy is to encourage development that is site responsive, promotion environmental sustainability through design, which will guide assessment and decision-making in the policy area to achieve the purpose of the special control area, which is:

- (a) To preserve the ecological values of the river and riparian zone;
- (b) To avoid development which would negatively impact upon the qualities of the area;
- (c) To ensure that land use in the area does not degrade the area;
- (d) To ensure that any development takes place in such a manner so as to safeguard the lives and property of people in the area; and
- (e) To ensure that any development does not obstruct flows and adversely alter flood behaviour.

4. Approval requirements

Development approval is required to construct or extend a single house and ancillary outbuilding or the demolition of any building or structure.

In considering an application for development approval, the local government will have regard to the following –

- Notwithstanding the presumption against development that remains under SCA 3, where appropriate, this policy is to guide limited forms of rural living and ancillary development that protect and enhance the environmental attributes of the locality.
- Applications where the development may result in an obstruction to major river flows and increase flood levels upstream will not be approved.
- Applications within the floodplain will be subject to a minimum habitable floor level of 0.5 metres above the predicted 1 in 100 (1%) Annual Exceedance Probability (AEP), as determined by the Department of Water and Environmental Regulation, to provide adequate protection from major floods.
- Applications for development where the lot is abutting an undedicated road and/or unconstructed road or a lot that does not have direct frontage to a dedicated and/or unconstructed road may be refused until the road has been dedicated and/or constructed or access by means of a dedicated and constructed road is provided.

- Comments and advice provided from any relevant authority sought during the assessment of the application.

Amalgamation of lots prior to approval of a development application may be required to achieve the purpose and objectives of the special control area and this policy, particularly if significant variations are proposed.

The Development Plan in Appendix A of this policy identifies lots that are considered suitable for development and those lots where it may be necessary to amalgamate prior to any further development. Development will only be supported on the lots that comply with this policy.

5. Development Guidelines

General Provisions

The following provisions apply generally to development proposals in the Spencers Brook Special Control Area.

Location of Development

- All development to comply with the provisions of the R5 density code of the State Planning Policy 7.3 – Residential Design Codes.
- Notwithstanding the provisions contained elsewhere in the Scheme and this Policy, any variations to the setback and siting requirements will be considered on the basis of existing structures, vegetation, visual amenity and/or fire safety, provided such variation is consistent with the objectives of the zone.
- No ancillary infrastructure shall be constructed in front of the dwelling, including but not limited to carports, sheds, water tanks and telecommunications infrastructure.
- Amalgamation of lots may be necessary to facilitate suitable development as identified on the Development Plan (Appendix 1), particularly where building setback requirements cannot be satisfied.

Building Design & Materials

- Dwellings and outbuildings shall be designed and constructed of materials in keeping with the amenity of the site. The Council will be supportive of traditional Australian rural style dwellings with wide verandahs, simple forms and passive solar orientation. Walls and roofs with natural, muted toning will be supported.
- Proposals for second-hand or re-purposed dwellings, such as 'dongas' will not be supported.

- Sheds are to be designed and constructed of materials and colour schemes which are complementary to the main dwelling on the site. Where shed walls are constructed of concrete, it shall be coloured or bagged in appropriate earthy tones.
- Tree Planting/Landscape screening may be required as condition of development approval.

Excavation & Fill

- Excavation and fill is limited to a maximum of 500mm above or below existing ground level over the whole site unless otherwise required by comply with flooding provisions.
- Retaining walls should be a maximum height of 750mm.
- If a building is on stumps, the underfloor perimeter of the building must be enclosed.
- The maximum height of floor level above adjacent natural ground level for any stumped structure is 1m unless otherwise required to comply with flooding provisions.

Flooding

- The development of any lots within the SCA (whether they are contained within the floodplain or not) need to be accompanied by evidence that the development will not obstruct major river flows and increase flood levels upstream.
- Development of any lots within the SCA that are not covered by existing flood mapping will not be supported unless accompanied by a Flood Risk Assessment prepared by a suitably qualified person.
- Development wholly located within a defined 1 in 100 AEP floodplain area will be assessed on their individual merit. Some of the factors that need to be examined include depth of flooding, velocity of flow, possible structural and potential flood damage, and difficulty in evacuation during major floods and its regional benefit.
- A minimum habitable floor level of 0.5m above the 1 in 100 AEP shall be provided. (Note: The maximum building height of 9m set by clause 4.10.1 of LPS6 should be considered in the design of the dwelling.)
- The Department of Water and Environmental Regulation will be consulted during the application process.

Access

- Lots 16-43, 142-145, 150-152 and 28780 abut Thomas Street, which is a dedicated but unconstructed road. The Shire may require that some or all of

the road be upgraded or a contribution made to upgrade the road to a rural road standard, as part of a development application.

- Lots 1-15 either abut vacant Crown land or the railway reserve, or therefore do not abut a dedicated and/or constructed road. Accordingly, development of these lots would not be permitted unless other permanent access arrangements could be made, such as some form of easement or right-of-carriageway through another lot/s to a dedicated and/or constructed road.

Service & Drainage Requirements

- All dwellings shall be connected to an approved reticulated water service (i.e. scheme water).
- If no reticulated power supply is available, the landowner must demonstrate sufficient power is available to supply the dwelling and ancillary infrastructure. If a wind turbine or other structures are proposed, they must be incorporated into the approved plans.
- On-site effluent disposal shall be the responsibility of the individual landowner. The disposal of effluent shall be by way of an approved wastewater system in accordance with the *Health (Treatment of Sewerage and Disposal of Effluent and Liquid Waste) Regulations 1974*.
- The WA Government Sewerage Policy (2019) recommends a separation distance of:
 - 100 metres from a waterway measured outwards from the outer edge of the riparian vegetation. This setback distance may be reduced where it can be demonstrated the on-site sewerage system will not have a significant impact on the environment or public health. It is likely that a secondary treatment system will be required when seeking a reduced setback in accordance with the provisions of the Policy; and
 - 0.6 to 1.5 metres from the highest groundwater level, taking into account the range of seasonal groundwater conditions, depending on the soil type and the type of treatment system used. Fill may be used to achieve separation distances in accordance with the provisions of the Policy.

Bushfire Management Control

- All applications for development approval shall be accompanied by a Bushfire Attack Level Assessment (BAL) Report prepared by a suitably qualified person.
- Landowners are responsible for the implementation, and any ongoing requirements, outlined in the BAL Report.

Land Uses

- In determining applications for discretionary uses listed in the zoning Table, the Council shall have regard to the general objectives of the zone, the key objectives and provisions of this policy.
- The Council contemplates that predominant form of development on each lot is likely to be a modestly proportioned single dwelling. In order to ensure non-residential uses provide for the protection of the rural townsite amenity, the Council will not grant development approval unless it is satisfied that the proposed use would not have an adverse impact on the amenity of the locality;
- In addition to the general development provisions, in granting development approval, the Council may assess and where appropriate apply conditions in relation to any of the following matters:
 - advertising signage,
 - vehicle access and parking,
 - Building location and setbacks,
 - External appearance, colours and finishes,
 - Size and scale of non-residential buildings and land-uses,
 - Storage and disposal of wastes,
 - Emission of noise, dust and odour,
 - Extent and standard of landscape screening,
 - Hours of operation.

DEVELOPMENT PLAN

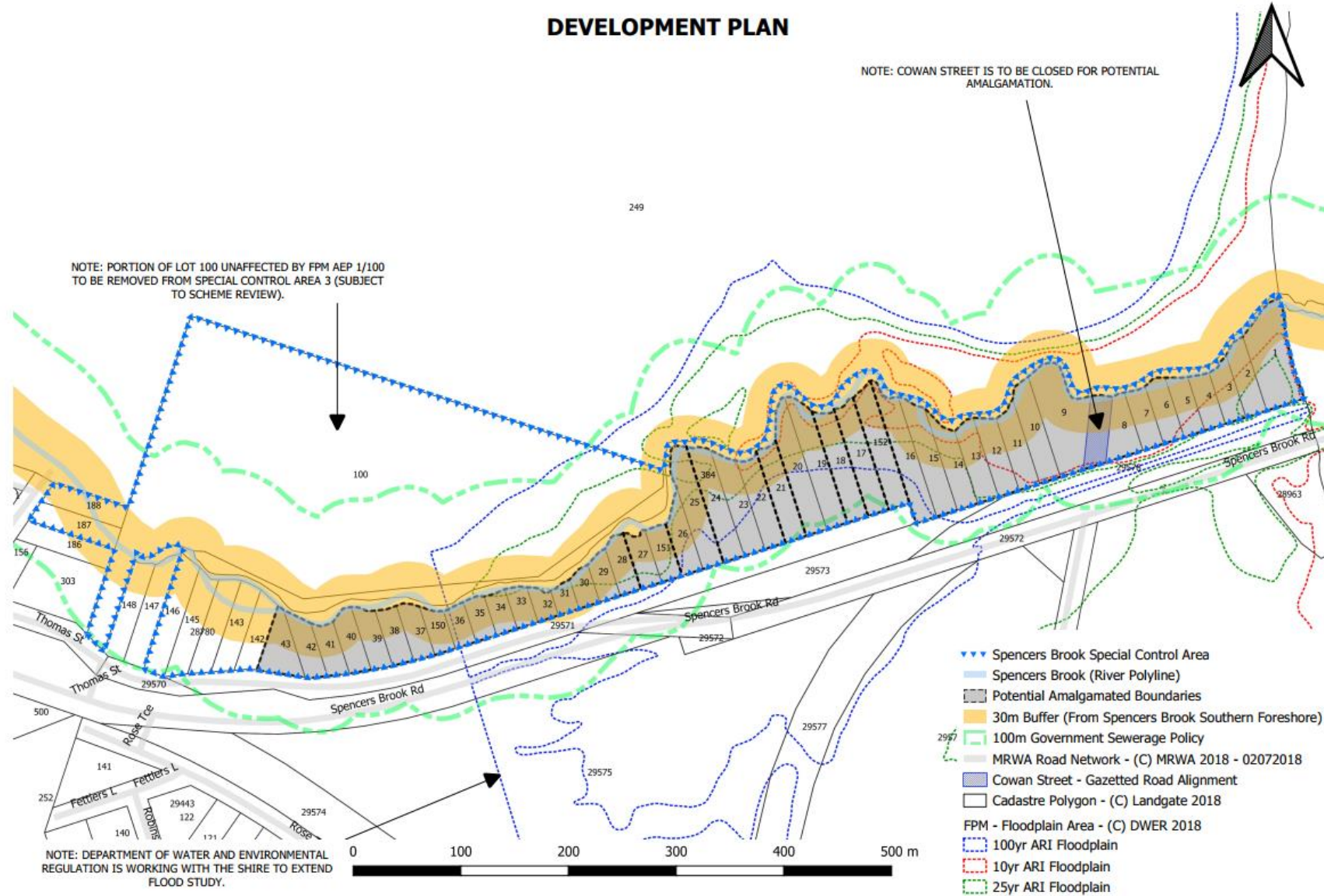

Attachment 2

Shire of Northam Local Planning Scheme No. 6 LPP 25 – Spencers Brook SCA Schedule of Submissions

No.	Name	Summary of Submission	Officers Comment
1	Nicholas & Adele Tandy, Lot 21 Spencers Brook Rd, Spencers Brook.	<ul style="list-style-type: none"> • Have read the draft policy and points provided by Altus Planning. • After studying Altus's suggested amendments, we are in agreement. • Particularly in reference to 'off grid ethos' and amalgamation. • Agree with Altus's suggestion that amalgamation will not benefit the area as it may encourage larger development. • Agree that sealing the road is unnecessary and should not be an impediment. • Envisaged a small environmentally friendly off grid home when originally applied to protect area from larger development and precedents. 	Submission Noted. Refer to comments to Submission No. 3.
2	Greg Beange, 20 Thomas St, Spencers Brook.	<ul style="list-style-type: none"> • Lot 100 is 9 hectares and triangular in shape. • Strongly support the policy objectives. • Objects to property being included in the SCA. • Recent experience of the 1 in 100 year flood and living there for over 25 years, the northern edge of the 100 year flood zone on the Western side of the red line is 30 to 35 metres 	Agree with submission that the majority of the property could be removed from the SCA and therefore the policy area. Policy area amended with a view to reviewing the SCA area during the upcoming Scheme review.

No.	Name	Summary of Submission	Officers Comment
		<p>from the centre of the brook as it passes my property.</p> <ul style="list-style-type: none"> Photographs in submission and contours show property rises quite sharply, meaning 70% of my property is above the 100 year flood zone. Presumption against development will affect future development, such as a granny flat or new residence. Requests property be excluded from policy and continue to prohibit building within 100 year flood zone. 	
3	Altus Planning on behalf of owners of Lots 21-26 Thomas St, Spencers Brook.	<ul style="list-style-type: none"> Reviewed draft policy and have identified issues that require further consideration. Broad terms generally support the policy, subject to edits and improvements being made. Objectives duplicate purpose of the SCA. They should more sharply define and delineate parameters of development. Provides examples of objectives. Understands Shire's desire to emphasise current presumption against development, however policy should be to guide development and suggests first dot point in section 4 be reworded. Proposed amalgamation should be further considered to determine what benefit, if any, will be achieved. 	<p>Submission noted.</p> <p>Disagree with the comments partially regarding amalgamation, particularly where there are landowners have made submissions supporting amalgamation. Noting the development plan has been reviewed in consideration of the submissions.</p> <p>Agree partially with the recommendations made in the submission as follows:</p> <ul style="list-style-type: none"> Amend the policy objectives to encourage development as follows: <ul style="list-style-type: none"> "The purpose of this Policy is to encourage development that is site responsive, promotion environmental sustainability through design, which will guide assessment and decision-making

No.	Name	Summary of Submission	Officers Comment
		<ul style="list-style-type: none"> • Current plans does not clearly illustrate why some lots are highlighted for amalgamation whilst others are not. E.g. Lots 17, 18 and 152 are not, Lots 19-20, 21-22, 23-24 and 25-26 are. • Fundamental difficulty with encouraging lot amalgamation is: <ul style="list-style-type: none"> ○ Larger lots will increase the expectation of more intense development; ○ Must be approved by WAPC and likely a suite of servicing requirements will be imposed with little regard to 'off-the-grid' ethos of LPP; ○ Many lots, no matter what number are combined, will not improve development potential (i.e. Lots 1 to 15) that have no land outside the 100 year floodplain. • Reference to the "Detailed Site Investigation Report prepared by Altus Planning dated January 2019" be deleted since it is not included in the policy. • The plan from the site investigate report should replace the plan at Appendix A of the draft policy to provide greater clarity for current and future landowners. • Replace last 2 paragraphs in section 4 with the suggested wording. • Delete references to amalgamation in section 5, location of development. 	<p>in the policy area to achieve the purpose of the special control area, which is"</p> <ul style="list-style-type: none"> • Amend the first dot point in section 4 as follows: <ul style="list-style-type: none"> ○ "Notwithstanding the presumption against development that remains under SCA 3, where appropriate, this policy is to guide limited forms of rural living and ancillary development that protect and enhance the environmental attributes of the locality." • Replace the last paragraph in section 4, which will delete the reference to the Altus Report, with: <ul style="list-style-type: none"> ○ "The Development Plan in Appendix A of this policy identifies lots that are considered suitable for development and those lots where it may be necessary to amalgamate prior to any further development. Development will only be supported on the lots that comply with this policy." • Amend the access provisions in section 5 to include the words "to a rural road standard" after the words "the road".

No.	Name	Summary of Submission	Officers Comment
		<ul style="list-style-type: none"> • Access section does not provide clear understanding of what type of road or contribution. Contends an upgrade of Thomas St should not be a constructed, sealed road but should remain unsealed as long as it is safe and trafficable similar to other roads in the locality. • Contends that dwellings should not require a reticulated water service and can choose to live off-grid. Alternative is to recommend a minimum sized water tank. Provides suggested rewording. • Non-residential forms should be limited and suggests inclusion of an additional point. • Commends Shire for preparing LPP, which has the potential to provide greater certainty. • Lots located in the floodplain (1-15, 27-43, 151) should be identified as not suitable for development given their environmental constraints. • Submits several improvements need to be made before it becomes an efficient tool to assist decision making. • Draft LPP 25 should – better articulate ethos; promote design guidelines; revise development plan to more closely follow Altus report; reference to amalgamation should be largely removed. 	<ul style="list-style-type: none"> • Amend the first point of the service and drainage requirements in section 5 as follows: <ul style="list-style-type: none"> ○ “All dwellings shall be connected to an approved reticulated water service (i.e. scheme water). Where a reticulated water supply is unavailable, then a fit-for-purpose water supply shall be provided in accordance with the WAPC’s Rural Planning Guidelines.” • Amend the second point of the land uses provisions in section 5 by inserting the following section prior to the current provision: <ul style="list-style-type: none"> ○ “The Council contemplates that predominant for of development on each lot is likely to be a modestly proportioned single dwelling. In order”

No.	Name	Summary of Submission	Officers Comment
4	Richard Charlton, Lot 18 Spencers Brook Rd, Spencers Brook	<ul style="list-style-type: none"> • Sees no problems with anything in the draft. • Agrees with all proposals and feel that if adhered to can only benefit the area, owners and Shire. 	Submission noted.
5	Joan King, Lots 11-14 Spencers Brook Rd, Spencers Brook	<ul style="list-style-type: none"> • Pleased Shire has made progress by formulating a policy. • Previous policy discouraged potential buyers due to complicated regulations. • Encouraging to see proposal will protect unique landscapes while still allowing building. • Policy will give more certainty to future building proposals. • In regards to access to Lots 1 to 15, it is proposed to amalgamate lots 1 to 16 and create a small rural holding. • I purchased Lots 11-14 to join up with 15-16 to have access to Thomas St, which will then be suitable to build on. • Cowan St bisects area between Lots 8 and 9, which will cause a problem to amalgamate. Would Shire close this road reserve to amalgamate? • Discharge of water from railway reserve through unmade road causes flood to lower blocks and should be diverted along railway reserve land. • Amalgamating Lots 19 and 20 is a good idea provide a good price can be achieved. 	<p>Submission noted.</p> <p>Recommend development plan be amended to reflect landowner's request.</p> <p>Recommend Council resolve to close Cowan Street and commenced required processes.</p> <p>Recommend Council commence discussions with the Public Transport Authority regarding the drainage concerns raised in the submission.</p>

No.	Name	Summary of Submission	Officers Comment
		<ul style="list-style-type: none"> Ideas for suitable dwelling and outbuilding designs would enhance area. Generally pleased with your proposals to give some certainty to prospective buyers. 	
6	Margaret Stevenson, on behalf of Margen Pty Ltd ATF The Stevenson Family Trust, Mortgagees in Possession of Lots 1-10 Spencers Brook Rd, Spencers Brook	<ul style="list-style-type: none"> Supports Joan King's comments regarding access. Commends policy regarding type of dwellings. Requests Cowan Street be closed and not allowed to be built on to enable Lots 1-16 to be amalgamated. Appreciates any assistance that can be given and open to suggestions to make area more attractive to future buyers. In favour of making fewer blocks with larger areas to keep the pretty location. 	Submission noted. Refer to comments to Submission No. 5.
7	Department of Water and Environmental Regulation	<ul style="list-style-type: none"> Supports the preparation of the policy and is generally satisfied with the document. Policy objectives – point (e) should read “To ensure that any development does not obstruct flows and adversely alter flood behaviour.” Approval requirements – The DWER have updated the terminology used in 1 in 100 (1%) Annual Exceedance Probability (AEP). The AEP is defined as the likelihood or probability of a flood of a given size, or larger, occurring in any one year; usually expressed as a percentage. Development Guidelines – Flooding: 	Agree with DWER comments as the expert agency in flooding. Policy to be amended accordingly.

No.	Name	Summary of Submission	Officers Comment
		<ul style="list-style-type: none"> ○ Point 2 should read “Development of any lots within the SCA that are not covered by existing flood mapping will not be supported ...” ○ Point 3: The DWER recommend that proposed developments within the floodplain are assessed on their individual merit. Some of the factors examined include depth of flooding, velocity of flow, its obstructive effects on flow, possible structural and potential flood damage, and difficulty in evacuation during major floods and its regional benefit. ○ Point 4: This should be updated to AEP. 	



12.4 CORPORATE SERVICES

12.4.1 Accounts & Statements of Accounts – September 2019

Address:	N/A
Owner:	N/A
Applicant:	N/A
File Reference:	2.1.3.4
Reporting Officer:	Kathy Scholz, Creditors Officer
Responsible Officer:	Colin Young, Executive Manager Corporate Service
Officer Declaration of Interest:	Nil
Voting Requirement:	Simple Majority
Press release to be issued:	No

BRIEF

For Council to receive the accounts for the period from 1 September 2019 to 30 September 2019.

ATTACHMENTS

Attachment 1: Accounts & Statements of Accounts – September 2019.
Attachment 2: Declaration.

A. BACKGROUND / DETAILS

The reporting of monthly financial information is a requirement under section 6.4 of the Local Government Act 1995, and Regulation 34 of the Local Government (Financial Management) Regulations.

Pursuant to Financial Management Regulation 13, a list of payments made from Municipal and Trust accounts is required to be presented to Council on a periodical basis. These details are included as Attachment 1. In accordance with Financial Management Regulation 12, the Chief Executive Officer has delegated authority to make these payments.

B. CONSIDERATIONS

B.1 Strategic Community / Corporate Business Plan

Theme Area 6: Governance & Leadership.

Outcome 6.3: The Shire of Northam council is a sustainable, responsive, innovative and transparent organisation.

B.2 Financial / Resource Implications

Payments of accounts are in accordance with Council's 2019/20 Budget.

B.3 Legislative Compliance

Section 6.4 & 6.26(2) (g) of the Local Government Act 1995.
Financial Management Regulations 2007, Regulation 12 & 13.

B.4 Policy Implications

Nil.

B.5 Stakeholder Engagement / Consultation

Not applicable.

B.6 Risk Implications

Risk Category	Description	Rating (consequence x likelihood)	Mitigation Action
Financial	Figures not reflecting the true financial situation	Low	There are processes in place to show compliance with relevant legislation
Health & Safety	N/A	N/A	N/A
Reputation	N/A	N/A	N/A
Service Interruption	N/A	N/A	N/A
Compliance	Report not being accepted by Council	Low	There are processes in place to show compliance with relevant legislation
Property	N/A	N/A	N/A
Environment	N/A	N/A	N/A

C. OFFICER'S COMMENT

The matter of Council 'supporting local business' has been raised over a long period. To assist in providing a greater understanding of the purchasing patterns of the Shire of Northam, the following graph summarises the payments made locally for the month of September 2019:

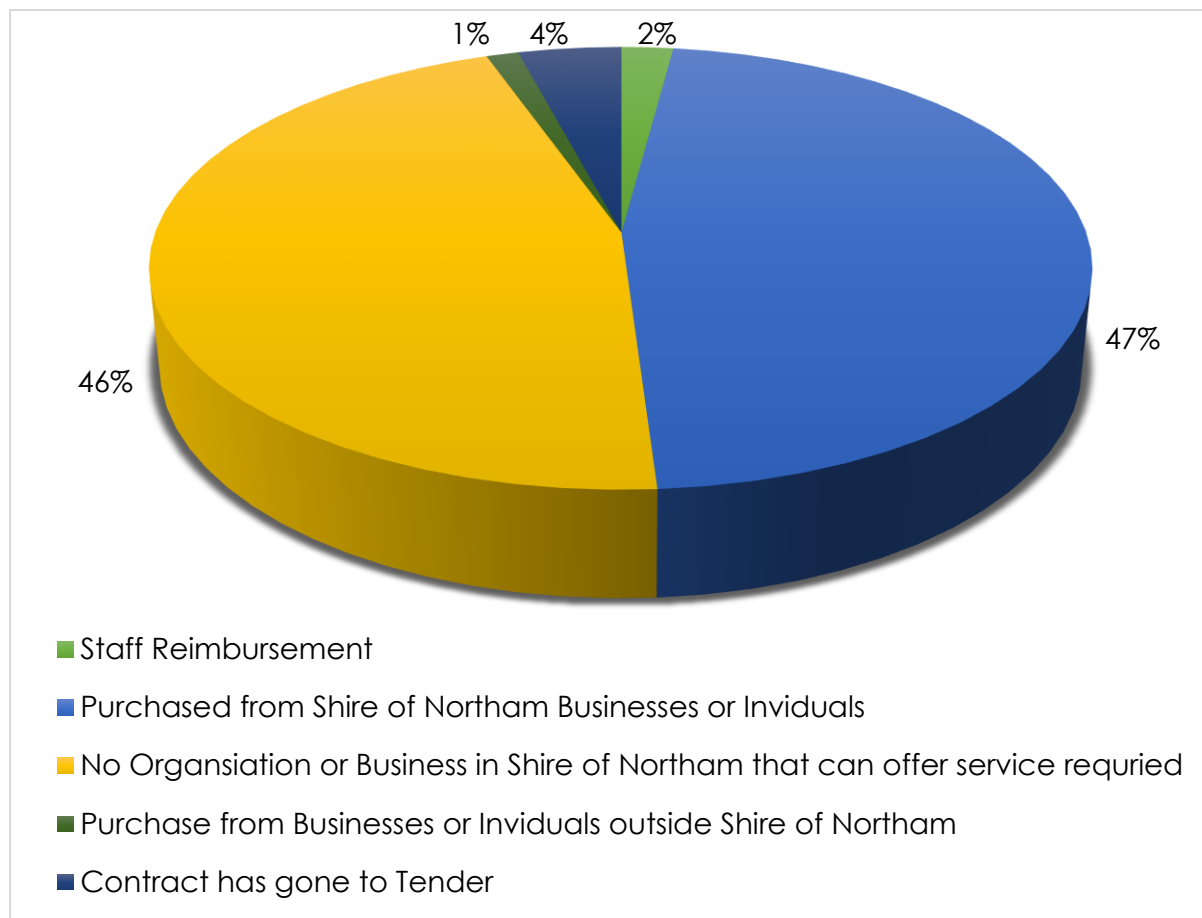

RECOMMENDATION / COUNCIL DECISION

Minute No: C.3786

Moved: Cr Della

Seconded: Cr Mencshelyi

That Council endorse the payments for the period 1 September 2019 to 30 September 2019, as listed, which have been made in accordance with the delegated authority reference number (M/F/F/Regs LGA 1995 S5.42).

CARRIED 6/0

The following clarification was provided prior to the Ordinary Council meeting:

Reference	Date	Details Reference	Question	Query By	Answer
EFT34141	9/09/19	Retail Decision (Coles)	Appears High. Breakdown available?	Cr Antonio	A bit higher than usual, about \$1,000, breakdown by department; BKB \$806, Admin Centre \$451, Create 298 \$48, Killara \$2,138, Library \$114, Rec Centre \$564 and Visitor Centre \$152
EFT34220	9/09/19	Zenien	CCTV repairs when community safety meeting reports they are not working?	Cr Antonio	Initial temporary repairs were carried out for the Cockatoo damage, other issues arisen at various locations and have since been rectified.
EFT34303	23/09/19	McLeods Barristers	Annual Audit Seems very low amount?	Cr Antonio	This expenditure was only for an audit compliance letter, in essence it states any outstanding cases, it is requested by Council auditors as part of the annual audit.

Attachment 1

Date: 02/10/2019
Time: 9:14:57AM

Shire of Northam

USER: Kathy Scholz
PAGE: 1

Cheque /EFT No	Date	Name	Invoice Description	Bank Code	INV Amount	Amount
2061	26/09/2019	SHIRE OF NORTHAM	PAYMENT FOR COLLECTION OF BSL FEES ON BEHALF OF THE CONSTRUCTION TRAINING FUND FOR THE MONTH OF AUGUST 2019.	2		88.25
INV T1080	26/09/2019	SHIRE OF NORTHAM	PAYMENT FOR COLLECTION OF BSL FEES ON BEHALF OF THE CONSTRUCTION TRAINING FUND FOR THE MONTH OF AUGUST 2019.	2	80.00	
INV T1079	26/09/2019	SHIRE OF NORTHAM	PAYMENT FOR COLLECTION OF BCITF FEES ON BEHALF OF THE CONSTRUCTION TRAINING FUND FOR THE MONTH OF AUGUST 2019.	2	8.25	
EFT34129	05/09/2019	HUNGRY BIRDS PIZZA	LUNCH PROVIDED FOR ACAT (GP NETWORK) AT BKB	1		173.00
INV 57	26/08/2019	HUNGRY BIRDS PIZZA	LUNCH PROVIDED FOR ACAT (GP NETWORK) AT BKB	1	173.00	
EFT34130	05/09/2019	JOANNE PARFITT	ABORIGINAL ART ROCKS	1		225.00
INV 1	19/08/2019	JOANNE PARFITT	ABORIGINAL ART ROCKS	1	150.00	
INV TAX1	19/08/2019	JOANNE PARFITT	STOCK PURCHASES FOR VISITORS CENTRE	1	75.00	
EFT34131	09/09/2019	ATTILA JOHN MENCSELYI	COUNCILLOR PAYMENTS FOR AUG 2019	1		1,905.73
INV AUG 20131/08/2019		ATTILA JOHN MENCSELYI	COUNCILLOR PAYMENTS FOR AUG 2019	1	1,905.73	
EFT34132	09/09/2019	BROOKLANDS SUPER PTY LTD	COUNCILLOR PAYMENTS AUG 2019	1		1,500.00
INV AUG 20131/08/2019		BROOKLANDS SUPER PTY LTD	COUNCILLOR PAYMENTS AUG 2019	1	1,500.00	
EFT34133	09/09/2019	CARL PHILLIP DELLA	COUNCILLOR PAYMENTS FOR AUG 2019	1		1,905.73
INV AUG 20131/08/2019		CARL PHILLIP DELLA	COUNCILLOR PAYMENTS FOR AUG 2019	1	1,905.73	
EFT34134	09/09/2019	CHRIS DAVIDSON	COUNCILLOR PAYMENTS AUG 2019	1		1,905.73
INV AUG 20131/08/2019		CHRIS DAVIDSON	COUNCILLOR PAYMENTS AUG 2019	1	1,905.73	

Ordinary Council Meeting Minutes
16 October 2019



Date: 02/10/2019
Time: 9:14:57AM

Shire of Northam

USER: Kathy Scholz
PAGE: 2

Cheque /EFT No	Date	Name	Invoice Description	Bank Code	INV Amount	Amount
EFT34135	09/09/2019	CHRISTOPHER RICHARD ANTONIO	COUNCILLOR PAYMENTS AUG 2019	1		5,305.36
INV AUG 20131/08/2019		CHRISTOPHER RICHARD ANTONIO	COUNCILLOR PAYMENTS AUG 2019	1	5,305.36	
EFT34136	09/09/2019	DAVID SPARROW RED SAXGUY	2019 AVON RIVER FESTIVAL - ENTERTAINMENT	1		1,250.00
INV I1908021 02/08/2019		DAVID SPARROW RED SAXGUY	2019 AVON RIVER FESTIVAL - ENTERTAINMENT	1	1,250.00	
EFT34137	09/09/2019	DUNNING INVESTMENTS PTY LTD	FUEL CHARGES FOR JULY 2019.	1		22,555.66
INV JULY 20131/07/2019		DUNNING INVESTMENTS PTY LTD	FUEL CHARGES FOR JULY 2019.	1	22,555.66	
EFT34138	09/09/2019	JOHN PROUD	COUNCILLOR PAYMENTS AUG 2019	1		1,905.73
INV AUG 20131/08/2019		JOHN PROUD	COUNCILLOR PAYMENTS AUG 2019	1	1,905.73	
EFT34139	09/09/2019	JULIE ELLEN GREENFIELD WILLIAMS	COUNCILLOR PAYMENTS AUG 2019	1		2,385.25
INV AUG 20131/08/2019		JULIE ELLEN GREENFIELD WILLIAMS	COUNCILLOR PAYMENTS AUG 2019	1	2,385.25	
EFT34140	09/09/2019	MICHAEL PATRICK RYAN	COUNCILLOR PAYMENTS FOR AUG 2019	1		2,843.23
INV AUG 20131/08/2019		MICHAEL PATRICK RYAN	COUNCILLOR PAYMENTS FOR AUG 2019	1	2,843.23	
EFT34141	09/09/2019	RETAIL DECISIONS (COLES)	COLES PURCHASES FOR JULY 2019.	1		4,283.96
INV JULY 20131/07/2019		RETAIL DECISIONS (COLES)	COLES PURCHASES FOR JULY 2019.	1	4,283.96	
EFT34142	09/09/2019	STEVEN BRUCE POLLARD	COUNCILLOR PAYMENTS AUG 2019	1		1,905.73
INV AUG 20131/08/2019		STEVEN BRUCE POLLARD	COUNCILLOR PAYMENTS AUG 2019	1	1,905.73	
EFT34143	09/09/2019	TERRY MATTHEW LITTLE	COUNCILLOR PAYMENTS AUG 2019	1		2,118.85
INV AUG 20131/08/2019		TERRY MATTHEW LITTLE	COUNCILLOR PAYMENTS AUG 2019	1	2,118.85	
EFT34144	09/09/2019	TIGERTURF AUSTRALIA PTY LTD	HOCKEY FIELD PROGRESS CLAIM 1.	1		321,586.10
INV 112192 30/08/2019		TIGERTURF AUSTRALIA PTY LTD	HOCKEY FIELD PROGRESS CLAIM 1.	1	321,586.10	
EFT34145	09/09/2019	TREVOR EASTWELL	DRIVE WUNDOWIE BUS FOR NIGHT HOOPS	1		720.00
INV 54 17/08/2019		TREVOR EASTWELL	DRIVE WUNDOWIE BUS FOR NIGHT HOOPS	1	720.00	

Ordinary Council Meeting Minutes
16 October 2019



Date: 02/10/2019
Time: 9:14:57AM

Shire of Northam

USER: Kathy Scholz
PAGE: 3

Cheque /EFT No	Date	Name	Invoice Description	Bank Code	INV Amount	Amount
EFT34146	09/09/2019	WRIGHT EXPRESS AUSTRALIA PTY LTD (PUMA ENERGY)	FUEL PURCHASES AT PUMA FOR JULY 2019.	1		757.25
INV JULY 2013107/2019		WRIGHT EXPRESS AUSTRALIA PTY LTD (PUMA ENERGY)	FUEL PURCHASES AT PUMA FOR JULY 2019.	1	757.25	
EFT34147	09/09/2019	ROBERT WAYNE TINETTI	COUNCILLOR PAYMENTS AUG 2019	1		1,905.73
INV AUG 2013108/2019		ROBERT WAYNE TINETTI	COUNCILLOR PAYMENTS AUG 2019	1	1,905.73	
EFT34148	09/09/2019	ABCO PRODUCTS	BERNARD PARK TOILETS. SUPPLY WATERLESS URINAL CHEMICAL 10L, AS PER QUOTE. ANDY TO PICK UP FROM NORTHAM.	1		763.62
INV 436545	06/08/2019	ABCO PRODUCTS	BERNARD PARK TOILETS. SUPPLY WATERLESS URINAL CHEMICAL 10L, AS PER QUOTE. ANDY TO PICK UP FROM NORTHAM.	1	763.62	
EFT34149	09/09/2019	ADVANTEERING - CIVIL ENGINEERS	PROGRESS CLAIM NUMBER 9 FOR WORKS COMPLETED 20/06/2019 TO 20/07/2019	1		2,435.40
INV 1088	22/08/2019	ADVANTEERING - CIVIL ENGINEERS	PROGRESS CLAIM NUMBER 9 FOR WORKS COMPLETED 20/06/2019 TO 20/07/2019	1	2,435.40	
EFT34150	09/09/2019	AGENCY HOLDINGS T/AS BILBY BADGES	4x NAME BADGES - M.ESLER, A.QUINN, A.VENN, ABUDARICK - KILLARA SUPPORT WORKERS FREIGHT COSTS	1		69.16
INV 2264	09/07/2019	AGENCY HOLDINGS T/AS BILBY BADGES	4x NAME BADGES - M.ESLER, A.QUINN, A.VENN, ABUDARICK - KILLARA SUPPORT WORKERS FREIGHT COSTS	1	69.16	
EFT34151	09/09/2019	AMPAC DEBT RECOVERY (WA) P/L	DEBT RECOVERY FOR AUGUST 2019	1		20,154.31
INV 57895	16/08/2019	AMPAC DEBT RECOVERY (WA) P/L	DEBT RECOVERY FOR AUGUST 2019	1	223.85	
INV 57961	29/08/2019	AMPAC DEBT RECOVERY (WA) P/L	DEBT RECOVERY FOR AUGUST 2019	1	19,930.46	
EFT34152	09/09/2019	AQUAMONIX PTY LTD	FLOWMETER REPLACEMENT PARTS AND TRAVEL TO AND FROM NORTHAM	1		1,152.80
INV 63718	07/08/2019	AQUAMONIX PTY LTD	FLOWMETER REPLACEMENT PARTS AND TRAVEL TO AND FROM NORTHAM	1	1,152.80	
EFT34153	09/09/2019	ASLAB PTY LTD	SUB BASE TESTING - BERT HAWKE HOCKEY FIELD	1		1,674.78
INV 0002249109/08/2019		ASLAB PTY LTD	SUB BASE TESTING - BERT HAWKE HOCKEY FIELD	1	1,674.78	

Ordinary Council Meeting Minutes
16 October 2019



Date: 02/10/2019
Time: 9:14:57AM

Shire of Northam

USER: Kathy Scholz
PAGE: 4

Cheque /EFT No	Date	Name	Invoice Description	Bank Code	INV Amount	Amount
EFT34154	09/09/2019	AURENDA PTY LTD	5 DAY INTRODUCTORY COURSE FOR OSH REPS (2 REMAINING DAYS) -TRAINING FOR JUDITH HAY, PATSY REPEC AND SUZANNE SAMS (SHIRE OF NORTHAM) DEPOSIT PAID \$2600 PO 53349	1		3,900.00
INV INV-001020/08/2019		AURENDA PTY LTD	DOT BOURKE & SHARLA SIMUNOV (SHIRE OF YORK) 5 DAY INTRODUCTORY COURSE FOR OSH REPS (2 REMAINING DAYS) -TRAINING FOR JUDITH HAY, PATSY REPEC AND SUZANNE SAMS (SHIRE OF NORTHAM) DEPOSIT PAID \$2600 PO 53349 DOT BOURKE & SHARLA SIMUNOV (SHIRE OF YORK)	1	3,900.00	
EFT34155	09/09/2019	AUSNET INDUSTRIES	INTERNATIONAL STANDARD FIELD HOCKEY GOALS (PAIR) AS PER QUOTE JGV REF 4414 JV20190813	1		6,311.80
INV INV-198027/08/2019		AUSNET INDUSTRIES	INTERNATIONAL STANDARD FIELD HOCKEY GOALS (PAIR) AS PER QUOTE JGV REF 4414 JV20190813	1	6,311.80	
EFT34156	09/09/2019	AUSTRALIAN COMMUNITY MEDIA	ADVERTISING FOR THE CONCLUSION OF WUNDOWIE TO NORTHAM BUS TRIAL	1		249.39
INV 5554886	07/08/2019	AUSTRALIAN COMMUNITY MEDIA	ADVERTISING FOR THE CONCLUSION OF WUNDOWIE TO NORTHAM BUS TRIAL	1	249.39	
EFT34157	09/09/2019	AUSTRALIAN SERVICES UNION	PAYROLL DEDUCTION	1		103.60
INV DEDUCT03/09/2019		AUSTRALIAN SERVICES UNION	PAYROLL DEDUCTION		103.60	
EFT34158	09/09/2019	AUSTRALIAN TAXATION OFFICE - PAYG	EAYG PAY RUN WEEK END 03/09/2019.	1		63,528.00
INV PAYG03/03/09/2019		AUSTRALIAN TAXATION OFFICE - PAYG	EAYG PAY RUN WEEK END 03/09/2019.	1	63,528.00	
EFT34159	09/09/2019	AVON COMMUNITY DEVELOPMENT FOUNDATION	ACDF SUBSCRIPTION 2019/2020FY	1		1,100.00
INV 2019/2020/05/07/2019		AVON COMMUNITY DEVELOPMENT FOUNDATION	ACDF SUBSCRIPTION 2019/2020FY	1	1,100.00	
EFT34160	09/09/2019	AVONDEMOLITION & EARTHMOVING	MANAGEMENT OF INKPEN WASTE MANAGEMENT FACILITY - APPROX 30 HRS PER WEEK @ \$30 PER HOUR, PLUS 2 PUBLIC HOLIDAYS, 6 MONTHS	1		1,568.00
INV 0014	25/08/2019	AVONDEMOLITION & EARTHMOVING	MANAGEMENT OF INKPEN WASTE MANAGEMENT FACILITY - APPROX 30 HRS PER WEEK @ \$30 PER HOUR, PLUS 2 PUBLIC HOLIDAYS, 6 MONTHS	1	1,568.00	
EFT34161	09/09/2019	AVON FIBRE TECH	2019 AVON RIVER FESTIVAL - FIREWORKS PONTOON.	1		550.00

Ordinary Council Meeting Minutes
16 October 2019



Date: 02/10/2019
Time: 9:14:57AM

Shire of Northam

USER: Kathy Scholz
PAGE: 5

Cheque /EFT No	Date	Name	Invoice Description	Bank Code	INV Amount	Amount
INV 7	26/08/2019	AVON FIBRE TECH	2019 AVON RIVER FESTIVAL - FIREWORKS PONTOON.	1	550.00	
EFT34162	09/09/2019	AVON VALLEY ARTS SOCIETY (INC)	2019 NORTHAM ART PRIZE - GOLD LEVEL MEMBERSHIP.	1		3,000.00
INV 48810	29/07/2019	AVON VALLEY ARTS SOCIETY (INC)	2019 NORTHAM ART PRIZE - GOLD LEVEL MEMBERSHIP.	1	3,000.00	
EFT34163	09/09/2019	AVON VALLEY TOYOTA	10,000 SERVICE KILLARA4HIACE COMMUTER BUS	1		297.33
INV 336287	13/08/2019	AVON VALLEY TOYOTA	10,000 SERVICE KILLARA4HIACE COMMUTER BUS	1	297.33	
EFT34164	09/09/2019	AVON WASTE	2019 AVON RIVER FESTIVAL: 40X BINS + 1X3M3 SKIP	1		854.30
INV 0003520426/08/2019		AVON WASTE	2019 AVON RIVER FESTIVAL: 40X BINS + 1X3M3 SKIP	1	854.30	
EFT34165	09/09/2019	AVONVALE EDUCATION SUPPORT CENTRE	AVON RIVER FESTIVAL STREET PARADE PRIZE 2019	1		425.00
INV VW14/08.14/08/2019		AVONVALE EDUCATION SUPPORT CENTRE	AVON RIVER FESTIVAL STREET PARADE PRIZE 2019	1	425.00	
EFT34166	09/09/2019	AVONVALE PRIMARY SCHOOL	REFUND FOR BOOKING #3941	1		100.00
INV #3941	20/08/2019	AVONVALE PRIMARY SCHOOL	REFUND FOR BOOKING #3941	1	100.00	
EFT34167	09/09/2019	BANDIT TREE EQUIPMENT	DIAGNOSE STARTING FAULT AND TEST SYSTEM FOUND TO NOT BE A WARRANTY ISSUE DUE TO DAMAGE TO INSIDE FUEL PUMP DUE TO DIRTY FUEL.	1		1,523.49
INV 0009968602/09/2019		BANDIT TREE EQUIPMENT	DIAGNOSE STARTING FAULT AND TEST SYSTEM FOUND TO NOT BE A WARRANTY ISSUE DUE TO DAMAGE TO INSIDE FUEL PUMP DUE TO DIRTY FUEL.	1	1,523.49	
EFT34168	09/09/2019	BLACKWELL PLUMBING PTY LTD	DUMP POINT PEEL TERRACE. DUMP POINT IS BLOCKED, PLEASE CLEAR.	1		99.00
INV INV-199829/08/2019		BLACKWELL PLUMBING PTY LTD	DUMP POINT PEEL TERRACE. DUMP POINT IS BLOCKED, PLEASE CLEAR.	1	99.00	
EFT34169	09/09/2019	CDA AIR & SOLAR	MEMORIAL HALL. REPLACE OUTDOOR PCB AS PER QUOTE.	1		924.50
INV 0000755922/08/2019		CDA AIR & SOLAR	MEMORIAL HALL. REPLACE OUTDOOR PCB AS PER QUOTE.	1	924.50	
EFT34170	09/09/2019	CEMETERIES & CREMATORIA ASSOCIATION OF WA	CRDINARY MEMBERSHIP 2019/2020	1		125.00
INV 1054	27/08/2019	CEMETERIES & CREMATORIA ASSOCIATION OF WA	CRDINARY MEMBERSHIP 2019/2020	1	125.00	

Ordinary Council Meeting Minutes
16 October 2019



Date: 02/10/2019
Time: 9:14:57AM

Shire of Northam

USER: Kathy Scholz
PAGE: 6

Cheque /EFT No	Date	Name	Invoice Description	Bank Code	INV Amount	Amount
EFT34171	09/09/2019	COMBINED TYRES	CLACKLINE 2.4 - REMOVE, DIAGNOSE, REPAIR AND REFIT REAR RIGHT DUAL, SLOW LEAK (100 KPA PER WEEK)	1		176.00
INV INV-272302/09/2019		COMBINED TYRES	CLACKLINE 2.4 - REMOVE, DIAGNOSE, REPAIR AND REFIT REAR RIGHT DUAL, SLOW LEAK (100 KPA PER WEEK)	1	176.00	
EFT34172	09/09/2019	COUNTRY COPIERS NORTHAM	COLOUR COPIER SERVICE/METER READING - ADMIN	1		3,591.09
INV S7846	27/08/2019	COUNTRY COPIERS NORTHAM	COLOUR COPIER SERVICE/METER READING - ADMIN	1	2,205.83	
INV S7834	27/08/2019	COUNTRY COPIERS NORTHAM	IRA-C2230 DEPO COLOUR COPIER SERVICE/METER READING AS PER SPREADSHEET	1	1,385.26	
EFT34173	09/09/2019	COUNTRYWIDE GROUP	LS+OIL FOR SMALL PLANT.	1		60.00
INV 27882	20/08/2019	COUNTRYWIDE GROUP	LS+OIL FOR SMALL PLANT.	1	60.00	
EFT34174	09/09/2019	COVS PARTS PTY LTD	FN1407 - FUEL CAP.	1		46.40
INV 1690059302/08/2019		COVS PARTS PTY LTD	FN1407 - FUEL CAP.	1	46.40	
EFT34175	09/09/2019	ROAD AND TRAFFIC SERVICES	INSTALL PAVEMENT MARKING AS PER DRAWINGS AND QUOTE 19CP151 INCLUDING SUPPLY AND INSTALLATION OF BOLLARD IN SHARED ZONE FOR VISITOR CENTRE PARKING AREA..	1		1,061.50
INV 0000798224/07/2019		ROAD AND TRAFFIC SERVICES	INSTALL PAVEMENT MARKING AS PER DRAWINGS AND QUOTE 19CP151 INCLUDING SUPPLY AND INSTALLATION OF BOLLARD IN SHARED ZONE FOR VISITOR CENTRE PARKING AREA..	1	1,061.50	
EFT34176	09/09/2019	E FIRE & SAFETY	TOWN HALL. FIRE SERVICES PANEL INSPECTIONS FOR MAY.	1		162.80
INV 502683	31/05/2019	E FIRE & SAFETY	TOWN HALL. FIRE SERVICES PANEL INSPECTIONS FOR MAY.	1	162.80	
EFT34177	09/09/2019	EASIFLEET	Payroll deductions	1		3,036.10
INV DEDUCT03/09/2019		EASIFLEET	Payroll deductions		1,421.55	
INV DEDUCT03/09/2019		EASIFLEET	Payroll deductions		1,614.55	
EFT34178	09/09/2019	EXECUTIVE MEDIA PTY LTD	CARAVANNING AUSTRALIA SPRING 2019	1		1,995.00

Date: 02/10/2019
Time: 9:14:57AM

Shire of Northam

USER: Kathy Scholz
PAGE: 7

Cheque /EFT No	Date	Name	Invoice Description	Bank Code	INV Amount	Amount
INV 161509	14/08/2019	EXECUTIVE MEDIA PTY LTD	CARAVANNING AUSTRALIA SPRING 2019	1	1,995.00	
EFT34179	09/09/2019	GDR CIVIL CONTRACTING PTY LTD	FLOAT HIRE - SHIFT ROLLER GENTLE ROAD TO BORAMIN ROAD	1		660.00
INV 001537	09/08/2019	GDR CIVIL CONTRACTING PTY LTD	FLOAT HIRE - SHIFT ROLLER GENTLE ROAD TO BORAMIN ROAD	1	660.00	
EFT34180	09/09/2019	GLENN STUART BEVERIDGE	REPAIRS TO ADMIN BUILDING.	1		209.00
INV 94	21/08/2019	GLENN STUART BEVERIDGE	REPAIRS TO ADMIN BUILDING.	1	209.00	
EFT34181	09/09/2019	GRAFTON ELECTRICS	SOUND SHELL/BERNARD PARK LIGHTS. ATTEND TO LOOK AT LIGHTING FOR AVON DESCENT FESTIVAL.	1		830.16
INV 6136	15/07/2019	GRAFTON ELECTRICS	SOUND SHELL/BERNARD PARK LIGHTS. ATTEND TO LOOK AT LIGHTING FOR AVON DESCENT FESTIVAL.	1	346.50	
INV 6154	19/07/2019	GRAFTON ELECTRICS	OLD TOWN ADMIN. (CREATE 298) LIGHT SWITCH IN OLD CHAMBERS IS CRACKLING WHEN TURNED ON, PLEASE REPLACE.	1	121.21	
INV 6166	24/07/2019	GRAFTON ELECTRICS	FOP UP SHOP. DISCONNECT FRONT AND BACK ALARMS AND CHECK POWER AS HIGH CONSUMPTION WHEN NOT IN USE.	1	165.00	
INV 6164	24/07/2019	GRAFTON ELECTRICS	ADMIN BUILDING. REPAIR ELECTRICAL POINT IN FRONT ADMIN AREA.	1	197.45	
EFT34182	09/09/2019	GROVE WESLEY DESIGN ART	REPLACEMENT GROUND SPIKES FOR BKB TEAR DROP BANNERS	1		209.00
INV 5676	23/08/2019	GROVE WESLEY DESIGN ART	REPLACEMENT GROUND SPIKES FOR BKB TEAR DROP BANNERS	1	209.00	
EFT34183	09/09/2019	INTERNATIONAL CITIES, TOWN CENTRES AND COMMUNITIES SOCIETY INC	ICTC CONFERENCE 2019 ROSS RAYSON & MICHELLE BLACKHURST.	1		2,350.00
INV 210	04/09/2019	INTERNATIONAL CITIES, TOWN CENTRES AND COMMUNITIES SOCIETY INC	ICTC CONFERENCE 2019 ROSS RAYSON & MICHELLE BLACKHURST.	1	2,350.00	
EFT34184	09/09/2019	IW PROJECTS	OLD QUARRY ROAD DRAINAGE CHANNEL INSTALLATION - ENVIRONMENTAL ENGINEERING CONSULTANT	1		7,499.25
INV 1092	02/08/2019	IW PROJECTS	OLD QUARRY ROAD DRAINAGE CHANNEL INSTALLATION - ENVIRONMENTAL ENGINEERING CONSULTANT	1	7,499.25	

Ordinary Council Meeting Minutes
16 October 2019



Date: 02/10/2019
Time: 9:14:57AM

Shire of Northam

USER: Kathy Scholz
PAGE: 8

Cheque /EFT No	Date	Name	Invoice Description	Bank Code	INV Amount	Amount
EFT34185	09/09/2019	IXOM OPERATIONS PTY LTD	CHLORINE MONTHLY SERVICE FEE FOR TREATED WASTE WATER RETICULATION FOR THE PERIOD 01/07/2019 TO 31/07/2019.	1		348.50
INV 6137228	31/07/2019	IXOM OPERATIONS PTY LTD	CHLORINE MONTHLY SERVICE FEE FOR TREATED WASTE WATER RETICULATION FOR THE PERIOD 01/07/2019 TO 31/07/2019.	1	348.50	
EFT34186	09/09/2019	KIM COLBOURNE	WORKING WITH CHILDREN'S CHECK	1		87.00
INV 6798405714/08/2019		KIM COLBOURNE	WORKING WITH CHILDREN'S CHECK	1	87.00	
EFT34187	09/09/2019	KLEENWEST DISTRIBUTORS	CLEANING PRODUCTS FOR REC CENTRE.	1		162.47
INV 0004001214/08/2019		KLEENWEST DISTRIBUTORS	CLEANING PRODUCTS FOR REC CENTRE.	1	162.47	
EFT34188	09/09/2019	LIFE CYCLE WA	REFUND FOR BOOKING #3932	1		100.00
INV #3932	23/08/2019	LIFE CYCLE WA	REFUND FOR BOOKING #3932	1	100.00	
EFT34189	09/09/2019	MCLEODS BARRISTERS & SOLICITORS	CNGOING LEGAL REPRESENTATION REGARDING UNLAWFUL DEVELOPMENT OF 29 MCMULLEN ROAD, INCLUDING COUR ATTENDANCE ON 14TH AUGUST 2019	1		5,128.39
INV 109664	21/08/2019	MCLEODS BARRISTERS & SOLICITORS	CNGOING LEGAL REPRESENTATION REGARDING UNLAWFUL DEVELOPMENT OF 29 MCMULLEN ROAD, INCLUDING COUR ATTENDANCE ON 14TH AUGUST 2019	1	5,128.39	
EFT34190	09/09/2019	MOORE STEPHENS (WA) PTY LTD	BUDGET MODEL FOR 2019 2020 FINANCIALS MOORE STEPHENS	1		715.00
INV 628	02/08/2019	MOORE STEPHENS (WA) PTY LTD	BUDGET MODEL FOR 2019 2020 FINANCIALS MOORE STEPHENS	1	715.00	
EFT34191	09/09/2019	NADEGE VINICOMBE	REIMBURSEMENT FOR PRE-EMPLOYMENT MEDICAL	1		277.20
INV 131645	31/07/2019	NADEGE VINICOMBE	REIMBURSEMENT FOR PRE-EMPLOYMENT MEDICAL	1	277.20	
EFT34192	09/09/2019	NEWGROUND WATER SERVICES PTY LTD	FUMP PENTIAR MFA09A - F 50 X 32-200/211 7.5kW.	1		2,451.90
INV SO-2000128/08/2019		NEWGROUND WATER SERVICES PTY LTD	RESTRICTOR ORIFICE TEE.	1	34.65	
INV SO-2000128/08/2019		NEWGROUND WATER SERVICES PTY LTD	FUMP PENTIAR MFA09A - F 50 X 32-200/211 7.5kW.	1	2,417.25	
EFT34193	09/09/2019	NORTHAM BETTA ELECTRICAL	IG NEOCHEF 42L SMART INVERTER MICROWAVE OVEN MODEL:MS42960WS	1		480.00

Ordinary Council Meeting Minutes
16 October 2019



Date: 02/10/2019
Time: 9:14:57AM

Shire of Northam

USER: Kathy Scholz
PAGE: 9

Cheque /EFT No	Date	Name	Invoice Description	Bank Code	INV Amount	Amount
INV 2001000420/08/2019		NORTHAM BETTA ELECTRICAL	IG NEOCHEF 42L SMART INVERTER MICROWAVE OVEN MODEL:MS42960WS	1	480.00	
EFT34194	09/09/2019	NORTHAM COUNTRY CLUB INC	2019 NORTHAM GOLF CLUB SPONSHIP - KENNEDY CUP.	1		500.00
INV 2821	26/08/2019	NORTHAM COUNTRY CLUB INC	2019 NORTHAM GOLF CLUB SPONSHIP - KENNEDY CUP.	1	500.00	
EFT34195	09/09/2019	NORTHAM FEED & HIRE	REPLACEMENT COST OF 18KG GAS BOTTLE - NO MORE SERVICE FEES	1		378.00
INV 0002195	27/06/2019	NORTHAM FEED & HIRE	DOG & CAT FOOD AND OTHER MISCELLANEOUS ITEMS - JUNE	1	49.50	
INV 0000229716/08/2019		NORTHAM FEED & HIRE	DOG & CAT FOOD AND OTHER MISCELLANEOUS ITEMS - AUGUST	1	64.50	
INV 0000229819/08/2019		NORTHAM FEED & HIRE	DOG & CAT FOOD AND OTHER MISCELLANEOUS ITEMS - AUGUST	1	16.50	
INV 0000229320/08/2019		NORTHAM FEED & HIRE	REPLACEMENT COST OF 18KG GAS BOTTLE - NO MORE SERVICE FEES	1	165.00	
INV 0000230421/08/2019		NORTHAM FEED & HIRE	DOG & CAT FOOD AND OTHER MISCELLANEOUS ITEMS - AUGUST	1	16.50	
INV 0000230522/08/2019		NORTHAM FEED & HIRE	DOG & CAT FOOD AND OTHER MISCELLANEOUS ITEMS - AUGUST	1	16.50	
INV 0000231326/08/2019		NORTHAM FEED & HIRE	DOG & CAT FOOD AND OTHER MISCELLANEOUS ITEMS - AUGUST	1	16.50	
INV 0000231728/08/2019		NORTHAM FEED & HIRE	DOG & CAT FOOD AND OTHER MISCELLANEOUS ITEMS - AUGUST	1	16.50	
INV 0000231829/08/2019		NORTHAM FEED & HIRE	DOG & CAT FOOD AND OTHER MISCELLANEOUS ITEMS - AUGUST	1	16.50	
EFT34196	09/09/2019	NORTHAM MAZDA	80,000 KM SERVICE ON PN1519 N3433	1		474.78
INV 125338	21/08/2019	NORTHAM MAZDA	80,000 KM SERVICE ON PN1519 N3433	1	474.78	
EFT34197	09/09/2019	NORTHAM PRIMARY SCHOOL	AVON RIVER FESTIVAL STREET PARADE PRIZE 2019	1		425.00
INV VW14/08.14/08/2019		NORTHAM PRIMARY SCHOOL	AVON RIVER FESTIVAL STREET PARADE PRIZE 2019	1	425.00	
EFT34198	09/09/2019	NORTHAM TOWING SERVICE	REMOVE SILVER HYUNDAI SEDAN, IN CARPARK CPPOSITE MCDONALDS AND TAKE TO DEPOT	1		88.00
INV 208690	09/08/2019	NORTHAM TOWING SERVICE	REMOVE SILVER HYUNDAI SEDAN, IN CARPARK CPPOSITE MCDONALDS AND TAKE TO DEPOT	1	88.00	

Ordinary Council Meeting Minutes
16 October 2019



Date: 02/10/2019
Time: 9:14:57AM

Shire of Northam

USER: Kathy Scholz
PAGE: 10

Cheque /EFT No	Date	Name	Invoice Description	Bank Code	INV Amount	Amount
EFT34199	09/09/2019	NORTHAM WOMEN IN BUSINESS	AVON RIVER FESTIVAL STREET PARADE PRIZE 2019	1		250.00
INV VW14/08.14/08/2019		NORTHAM WOMEN IN BUSINESS	AVON RIVER FESTIVAL STREET PARADE PRIZE 2019	1	250.00	
EFT34200	09/09/2019	CASIS OUTDOOR STRUCTURES	REMOVE EXISTING BRICK PILLARS AND FOOTINGS REMOVE BROKEN CONCRETE SLAB, 2M X 1.2M DISPOSE OF RUBBLE RELAY CONCRETE SLAB	1		3,382.50
INV INV-043721/08/2019		CASIS OUTDOOR STRUCTURES	DRILL 16 HOLES IN LIMESTONE AT BERT HAWKE HOCKEY COURT	1	264.00	
INV INV-043521/08/2019		CASIS OUTDOOR STRUCTURES	SUPPLY AND INSTALL WHITE REFLECTIVE PAINT TO BEVELLED PORTION OF SM2 KERB ON THE ROAD SIDE CF NEW ISLAND AT YATES/NEWMAN ROAD	1	1,045.00	
INV INV-043421/08/2019		CASIS OUTDOOR STRUCTURES	INTERSECTION/BAKERS HILL. AS PER QUOTE QU-0464 REMOVE EXISTING BRICK PILLARS AND FOOTINGS REMOVE BROKEN CONCRETE SLAB, 2M X 1.2M DISPOSE OF RUBBLE RELAY CONCRETE SLAB	1	2,073.50	
EFT34201	09/09/2019	OXTER SERVICES	SOUTHERN/BROOK HALL. SUPPLY 3 X CARTONS TOILET ROLLS, 1 X TOILET SEAT, 1 X BOX GLOVES AND 1 X BOX CF URINAL BLOCKS.	1		580.19
INV 21616	14/08/2019	OXTER SERVICES	TOILETRIES FOR PUBLIC TOILETS AT THE AIRPORT	1	75.86	
INV 21635	16/08/2019	OXTER SERVICES	SOUTHERN/BROOK HALL. SUPPLY 3 X CARTONS TOILET ROLLS, 1 X TOILET SEAT, 1 X BOX GLOVES AND 1 X BOX CF URINAL BLOCKS.	1	325.17	
INV 21638	19/08/2019	OXTER SERVICES	BERNARD PARK TOILET. 1 X BOX TOILET PAPER.	1	76.10	
INV 21671	26/08/2019	OXTER SERVICES	GRASS VALLEY HALL. 3 X BOXES OF TOILET ROLL.	1	103.06	
EFT34202	09/09/2019	FALMER CIVIL CONSTRUCTION	ADDITIONAL TREATMENT REQUIRED TO BOX OUT 500MM LINE TREAT SUBGRADE, LAY 500MM CRUSH ROAD ROADBASE STABILISED COMPACT AND TRIM. AS PER QUOTE QT2285 SEE ATTACHED VARIATION	1		7,342.24
INV 0000248821/08/2019		FALMER CIVIL CONSTRUCTION	ADDITIONAL TREATMENT REQUIRED TO BOX OUT 500MM LINE TREAT SUBGRADE, LAY 500MM CRUSH ROAD ROADBASE STABILISED COMPACT AND TRIM. AS PER QUOTE QT2285 SEE ATTACHED VARIATION	1	7,342.24	
EFT34203	09/09/2019	PERTH SAFETY PRODUCTS PTY LTD	R7-1-4 B BICYCLE LANE SIGN BLACK ON WHITE.	1		462.00

Ordinary Council Meeting Minutes
16 October 2019



Date: 02/10/2019
Time: 9:14:57AM

Shire of Northam

USER: Kathy Scholz
PAGE: 11

Cheque /EFT No	Date	Name	Invoice Description	Bank Code	INV Amount	Amount
INV 0000912815/07/2019		PERTH SAFETY PRODUCTS PTY LTD	R7-1-4 B BICYCLE LANE SIGN BLACK ON WHITE.	1	462.00	
EFT34204	09/09/2019	ROAD AND TRAFFIC SERVICES PTY LTD	INSTALL PAVEMENT MARKING AS PER DRAWING AND ATTACHED QUOTATION INCLUDING SUPPLY AND INSTALLATION OF BOLLARD IN SHARED ZONE FOR NORTHAM LABRARY PARKING	1		1,111.00
INV 0000798324/07/2019		ROAD AND TRAFFIC SERVICES PTY LTD	INSTALL PAVEMENT MARKING AS PER DRAWING AND ATTACHED QUOTATION INCLUDING SUPPLY AND INSTALLATION OF BOLLARD IN SHARED ZONE FOR NORTHAM LABRARY PARKING	1	1,111.00	
EFT34205	09/09/2019	SLATER-GARTRELL SPORTS	10LT DRUMS WHITE LINE MARKING PAINT FOR HENRY STREET OVAL	1		492.80
INV SG35307/17/07/2019		SLATER-GARTRELL SPORTS	10LT DRUMS WHITE LINE MARKING PAINT FOR HENRY STREET OVAL	1	492.80	
EFT34206	09/09/2019	SLAV'S CLEANING SERVICE	BERNARD PARK & APEX PARK TOILETS. CLEANING FOR AUGUST	1		5,153.31
INV 24	27/08/2019	SLAV'S CLEANING SERVICE	BERNARD PARK & APEX PARK TOILETS. CLEANING FOR AUGUST	1	2,771.81	
INV 23	27/08/2019	SLAV'S CLEANING SERVICE	CREATE 298 TOP STORY. MONTHLY CLEANING CONTRACT AUGUST 2019.	1	528.00	
INV 20	27/08/2019	SLAV'S CLEANING SERVICE	BILYA KOORT BOODJA CENTRE. WEEKLY CONTRACT CLEANING UNTIL AUGUST 2019.	1	1,853.50	
EFT34207	09/09/2019	SOUTHERN METROPOLITAN REGIONAL COUNCIL	x 6000 COPIES OF WASTE CALENDARS	1		4,320.00
INV 14163	28/08/2019	SOUTHERN METROPOLITAN REGIONAL COUNCIL	x 6000 COPIES OF WASTE CALENDARS	1	4,320.00	
EFT34208	09/09/2019	SUSAN BURLEY	DRUM MUSTER INSPECTION (3430 DRUMS @ \$0.17 PER DRUM) CARRIED OUT ON THE 6TH & 7TH OF SEP 2019	1		583.10
INV 5	09/09/2019	SUSAN BURLEY	DRUM MUSTER INSPECTION (3430 DRUMS @ \$0.17 PER DRUM) CARRIED OUT ON THE 6TH & 7TH OF SEP 2019	1	583.10	
EFT34209	09/09/2019	SWAIN PHILIP	RELIEF HEALTH OFFICER - PHIL SWAIN FOR 12, 13, 16, 21, 22 & 23 AUGUST.	1		5,783.82
INV 200801	31/08/2019	SWAIN PHILIP	RELIEF HEALTH OFFICER - PHIL SWAIN FOR 12, 13, 16, 21, 22 & 23 AUGUST.	1	5,783.82	
EFT34210	09/09/2019	THE PAPER COMPANY OF AUSTRALIA	x 100 REAMS A4 PHOTOCOPY PAPER.	1		614.35

Ordinary Council Meeting Minutes
16 October 2019



Date: 02/10/2019
Time: 9:14:57AM

Shire of Northam

USER: Kathy Scholz
PAGE: 12

Cheque /EFT No	Date	Name	Invoice Description	Bank Code	INV Amount	Amount
INV 0004467814/08/2019		THE PAPER COMPANY OF AUSTRALIA	x 100 REAMS A4 PHOTOCOPY PAPER	1	614.35	
EFT34211	09/09/2019	TOYOTA MOTOR CORPORATION AUSTRALIA LIMITED	REFUND FOR BOOKING #3775 WAS CANCELLED A WEEK PRIOR TO GOING AHEAD	1		235.00
INV #3775	22/08/2019	TOYOTA MOTOR CORPORATION AUSTRALIA LIMITED	REFUND FOR BOOKING #3775 WAS CANCELLED A WEEK PRIOR TO GOING AHEAD	1	235.00	
EFT34212	09/09/2019	TRUSTEE FOR THE GREATIVE IQ TRUST T/A ANNA DIXON CONSULTING & CREATIVEIQ	CARAVAN AND CAMPING FEASIBILITY STUDY	1		7,337.00
INV INV-020814/08/2019		TRUSTEE FOR THE GREATIVE IQ TRUST T/A ANNA DIXON CONSULTING & CREATIVEIQ	CARAVAN AND CAMPING FEASIBILITY STUDY	1	7,337.00	
EFT34213	09/09/2019	TYREPOWER	REPLACE BACK TWO TYRES ON PN1601 REGO N11206 WITH MAXUIM TYRES WITH REPORT	1		595.98
INV 8265.129	26/08/2019	TYREPOWER	REPLACE BACK TWO TYRES ON PN1601 REGO N11206 WITH MAXUIM TYRES WITH REPORT	1	595.98	
EFT34214	09/09/2019	VINCELEC	REPLACE 1x FAULTY EMERGENCY BACK UP LIGHT IN HALLWAY OF MAIN BUILDING AT KILLARA	1		705.00
INV 1163	28/08/2019	VINCELEC	REPLACE 1x FAULTY EMERGENCY BACK UP LIGHT IN HALLWAY OF MAIN BUILDING AT KILLARA	1	395.86	
INV 1162	28/08/2019	VINCELEC	FAULT FINDING & REPLACE NIGHT LIGHT IN RM1 BATHROOM REPLACE 2x LAMPS IN COTTAGE OFFICE & 2x LAMPS IN COTTAGE LAUNDRY	1	309.14	
EFT34215	09/09/2019	WA CONTRACT RANGER SERVICES	FOUND DUTIES 12/8/2019 TO 25/08/2019.	1		3,377.00
INV 02283	24/08/2019	WA CONTRACT RANGER SERVICES	RANGER SERVICES FROM 12/08/19 - 23/08/19	1	1,089.00	
INV 02284	26/08/2019	WA CONTRACT RANGER SERVICES	FOUND DUTIES 12/8/2019 TO 25/08/2019.	1	1,848.00	
INV 02300	01/09/2019	WA CONTRACT RANGER SERVICES	CAT MANAGEMENT EXPENSE - AUGUST	1	440.00	
EFT34216	09/09/2019	WHEATBELT OFFICE & BUSINESS MACHINES	MONTHLY METER READING INVOICE FOR CREATE298 02/08/2019-05/09/2019	1		143.00
INV 208159	05/09/2019	WHEATBELT OFFICE & BUSINESS MACHINES	MONTHLY METER READING INVOICE FOR CREATE298 02/08/2019-05/09/2019	1	143.00	
EFT34217	09/09/2019	WHEATBELT SAFETYWEAR	X2 GLASSES CLEANER & X 3 BOXES EARPLUGS	1		160.00
INV 8965	08/08/2019	WHEATBELT SAFETYWEAR	X2 GLASSES CLEANER & X 3 BOXES EARPLUGS	1	160.00	

Ordinary Council Meeting Minutes
16 October 2019



Date: 02/10/2019
Time: 9:14:57AM

Shire of Northam

USER: Kathy Scholz
PAGE: 13

Cheque /EFT No	Date	Name	Invoice Description	Bank Code	INV Amount	Amount
EFT34218	09/09/2019	WUNDOWIE PROGRESS ASSOCIATION	GRANT FOR WUNDOWIE IRON FESTIVAL 2019	1		13,000.00
INV IV00000023/07/2019		WUNDOWIE PROGRESS ASSOCIATION	GRANT FOR WUNDOWIE IRON FESTIVAL 2019	1	13,000.00	
EFT34219	09/09/2019	ZENIEN	URGENT REPAIRS TO SHIRE CCTV INCLUDING WORK AT MT OMMANEY, BERNARD PARK, AND WAPOL	1		12,122.21
INV I6674	06/08/2019	ZENIEN	URGENT REPAIRS TO SHIRE CCTV INCLUDING WORK AT MT OMMANEY, BERNARD PARK, AND WAPOL	1	12,122.21	
EFT34220	13/09/2019	ADVANCED TRAFFIC MANAGEMENT (WA) PTY LTD	TRAFFIC MANAGEMENT FOR REMOVAL AND LAYING OF KERB FOR BYFIELD STREET. 3 TC'S CREW FOR TWO DAYS STARTING FRIDAY 14TH JUNE 2019 AND WEDNESDAY 19TH JUNE 2019 AT TIMES DISCUSSED WITH NADEEM.	1		1,047.20
INV 0012788527/06/2019		ADVANCED TRAFFIC MANAGEMENT (WA) PTY LTD	TRAFFIC MANAGEMENT FOR REMOVAL AND LAYING OF KERB FOR BYFIELD STREET. 3 TC'S CREW FOR TWO DAYS STARTING FRIDAY 14TH JUNE 2019 AND WEDNESDAY 19TH JUNE 2019 AT TIMES DISCUSSED WITH NADEEM.	1	1,047.20	
EFT34221	13/09/2019	ANDY'S PLUMBING SERVICE	NORTHAM POUND. UNBLOCK DRAINS AND PUMP OUT TANKS.	1		4,180.00
INV A.18483	27/08/2019	ANDY'S PLUMBING SERVICE	SOUTHERN BROOK HALL. EMPTY SEPTIC TANK.	1	1,595.00	
INV A.18484	27/08/2019	ANDY'S PLUMBING SERVICE	CARAVAN DUMP POINT. UNBLOCK CARAVAN DUMP POINT.	1	517.00	
INV A.18482	27/08/2019	ANDY'S PLUMBING SERVICE	NORTHAM POUND. UNBLOCK DRAINS AND PUMP OUT TANKS.	1	2,068.00	
EFT34222	13/09/2019	AUSTRALIAN COMMUNICATIONS & MEDIA AUTHORITY	LAND MOBILE/LAND MOBILE SYSTEM - > 30MHz WAWA. SITE BOBAKINE HILLS OFF TOODYAY ROAD CLACKLINE LICENCE # 276428/1	1		557.00
INV 5017650215/08/2019		AUSTRALIAN COMMUNICATIONS & MEDIA AUTHORITY	LAND MOBILE/LAND MOBILE SYSTEM - > 30MHz WAWA. SITE BOBAKINE HILLS OFF TOODYAY ROAD CLACKLINE LICENCE # 276428/1	1	557.00	
EFT34223	13/09/2019	AVON DEMOLITION & EARTHMOVING	MANAGEMENT OF INKPEN WASTE MANAGEMENT FACILITY 27/08/2019 TO 08/09/2019.	1		1,568.00
INV 0015	08/09/2019	AVON DEMOLITION & EARTHMOVING	MANAGEMENT OF INKPEN WASTE MANAGEMENT FACILITY 27/08/2019 TO 08/09/2019.	1	1,568.00	

Ordinary Council Meeting Minutes
16 October 2019



Date: 02/10/2019
Time: 9:14:57AM

Shire of Northam

USER: Kathy Scholz
PAGE: 14

Cheque /EFT No	Date	Name	Invoice Description	Bank Code	INV Amount	Amount
EFT34224	13/09/2019	AVON VALLEY CONTRACTORS	SUPPLY AND DELIVER OF LARGE GRAVEL ROCK TO OLD CAURRY ROAD WASTE MANAGEMENT FACILITY. 125T @	1		3,047.00
INV 2945	30/08/2019	AVON VALLEY CONTRACTORS	COLLECT ROLLER FROM CAROL ROAD GRASS VALLEY & DELIVER TO ROGERS ROAD.	1	297.00	
INV 2956	05/09/2019	AVON VALLEY CONTRACTORS	SUPPLY AND DELIVER OF LARGE GRAVEL ROCK TO OLD CAURRY ROAD WASTE MANAGEMENT FACILITY. 125T @	1	2,750.00	
EFT34225	13/09/2019	AVON VALLEY PLANT & EQUIPMENT PTY LTD	YELLOW SAND.	1		933.90
INV IV10443	26/08/2019	AVON VALLEY PLANT & EQUIPMENT PTY LTD	YELLOW SAND.	1	933.90	
EFT34226	13/09/2019	AVON WASTE	MANAGEMENT OF THE OLD QUARRY ROAD WASTE MANAGEMENT FACILITY AUGUST 2019.	1		158,323.54
INV 34811	19/07/2019	AVON WASTE	RUBBISH COLLECTION FOR THE FORTNIGHT ENDING 19/07/2019.	1	37,515.28	
INV 35176	02/08/2019	AVON WASTE	RUBBISH COLLECTION P/E 02/08/2019.	1	36,835.52	
INV 35198	16/08/2019	AVON WASTE	RUBBISH COLLECTION FOR THE F/E 16/08/2019.	1	37,238.36	
INV 0003553230/08/2019		AVON WASTE	MANAGEMENT OF THE OLD QUARRY ROAD WASTE MANAGEMENT FACILITY AUGUST 2019.	1	46,734.38	
EFT34228	13/09/2019	BLUE DIAMOND MACHINERY PTY LTD	1775W X 650 DX 500 W TOOL BOX. INCL. STAINLESS T-LOCKS AND RUBBER SEALS.	1		535.00
INV SI-00044804/09/2019		BLUE DIAMOND MACHINERY PTY LTD	1775W X 650 DX 500 W TOOL BOX. INCL. STAINLESS T-LOCKS AND RUBBER SEALS.	1	535.00	
EFT34229	13/09/2019	BOEKEMAN MACHINERY	SUPPLY AND DELIVER NEW BARRETT 450KG 18 PLATE/DISC HARROWS ENCLUDING ALL 3 ATTACHING PINS AND ANY HARDWARE/FASTENERS ARE TIGHT AS PER QUOTE 3-08-2019 11.36AM	1		3,960.00
INV 271818	09/09/2019	BOEKEMAN MACHINERY	SUPPLY AND DELIVER NEW BARRETT 450KG 18 PLATE/DISC HARROWS ENCLUDING ALL 3 ATTACHING PINS AND ANY HARDWARE/FASTENERS ARE TIGHT AS PER QUOTE 3-08-2019 11.36AM	1	3,960.00	
EFT34230	13/09/2019	BOFFIN'S BOOKS	DARK EMU BOOKS	1		359.82
INV INV012208/07/2019		BOFFIN'S BOOKS	DARK EMU BOOKS	1	359.82	
EFT34231	13/09/2019	BOW STEEL PTY LTD	NORTHAM AERODROME. REPAIR AND SERVICE FRONT SLIDING GATE.	1		302.50

Ordinary Council Meeting Minutes
16 October 2019



Date: 02/10/2019
Time: 9:14:57AM

Shire of Northam

USER: Kathy Scholz
PAGE: 15

Cheque /EFT No	Date	Name	Invoice Description	Bank Code	INV Amount	Amount
INV 529	19/08/2019	BOW STEEL PTY LTD	NORTHAM AERODROME. REPAIR AND SERVICE FRONT SLIDING GATE.	1	302.50	
EFT34232	13/09/2019	CANNON HYGIENE AUSTRALIA PTY LTD	SANITARY BIN SERVICINGFOR JUL, AUG & SEP.	1		424.64
INV 9645041614/08/2019		CANNON HYGIENE AUSTRALIA PTY LTD	SANITARY BIN SERVICINGFOR JUL, AUG & SEP.	1	424.64	
EFT34233	13/09/2019	CENTRAL MOBILE MECHANICAL REPAIRS	REPAIRS TO HLAB CRANE NOT WORKING ON TRUCK EN0913 - N.3805.	1		132.00
INV 0000284123/08/2019		CENTRAL MOBILE MECHANICAL REPAIRS	REPAIRS TO HLAB CRANE NOT WORKING ON TRUCK EN0913 - N.3805.	1	132.00	
EFT34234	13/09/2019	CENTRAL REGIONAL TAFE	SUSAN BURLEY REGULATORY OFFICER COMPLIANCE SKILLS TRAINING 6/08 - 9/08/2019	1		468.16
INV 10008275 06/08/2019		CENTRAL REGIONAL TAFE	SUSAN BURLEY REGULATORY OFFICER COMPLIANCE SKILLS TRAINING 6/08 - 9/08/2019	1	329.20	
INV 10008489 20/08/2019		CENTRAL REGIONAL TAFE	ENROLMENT FEES NICOLE HAMPTON - FOLLOW OHS POLICIES WORK EFFECTIVELY IN LOCAL GOV'T	1	138.96	
EFT34235	13/09/2019	COUNTRYWIDE GROUP	ROLLWHPPER SNIPPER CORD.	1		110.00
INV 27958	03/09/2019	COUNTRYWIDE GROUP	ROLLWHPPER SNIPPER CORD.	1	110.00	
EFT34236	13/09/2019	E & J LOGISTIC PTY LTD T/AS FLAT OUT FREIGHT	COLLECT 7 X BULKA BAGS COLD MIX ASPHALT FROM FULTON HOGAN AND DELIVER TO SHIRE OF NORTHAM DEPOT 116 PEEL TCE NORTHAM.	1		2,168.65
INV 0000090931/07/2019		E & J LOGISTIC PTY LTD T/AS FLAT OUT FREIGHT	COLLECT BULKA BAGS AND PAALETS FROM FULTON HOGAN AND DELIVER TO SHIRE OF NORTHAM DEPOT.	1	500.00	
INV 0000090931/07/2019		E & J LOGISTIC PTY LTD T/AS FLAT OUT FREIGHT	COLLECT 3 BULKA BAGS OF COLD MIX FROM FULTON HOGAN AND DELIVER TO SHIRE OF NORTHAM DEPOT.	1	440.00	
INV 0000090931/07/2019		E & J LOGISTIC PTY LTD T/AS FLAT OUT FREIGHT	COLLECT 3 X 1T BULKA BAGS COLD MIX ASPHALT FROM FULTON HOGAN & DELIVER TO SHIRE OF NORTHAM DEPOT.	1	440.00	
INV 0000090931/07/2019		E & J LOGISTIC PTY LTD T/AS FLAT OUT FREIGHT	FREIGHT TO RETURN PLANS SCANNED AT CFFICEWORKS FOR LINLEY VALLEY PORK	1	18.65	
INV 0000090931/07/2019		E & J LOGISTIC PTY LTD T/AS FLAT OUT FREIGHT	COLLECT 7 X BULKA BAGS COLD MIX ASPHALT FROM FULTON HOGAN AND DELIVER TO SHIRE OF NORTHAM DEPOT 116 PEEL TCE NORTHAM.	1	770.00	
EFT34237	13/09/2019	E FIRE & SAFETY	KILLARA FIRE DETECTION SYSTEM MONTHLY SERVICING. 01/07/2019-31/07/2019	1		422.40

Ordinary Council Meeting Minutes
16 October 2019



Date: 02/10/2019
Time: 9:14:57AM

Shire of Northam

USER: Kathy Scholz
PAGE: 16

Cheque /EFT No	Date	Name	Invoice Description	Bank Code	INV Amount	Amount
INV 505906	31/07/2019	E FIRE & SAFETY	KILLARA FIRE DETECTION SYSTEM MONTHLY SERVICING. 01/07/2019-31/07/2019	1	422.40	
EFT34238	13/09/2019	FRONTLINE FIRE & RESCUE EQUIPMENT	PPE EQUIPMNET FOR BUSH FIRE BRIGADES.	1		6,895.02
INV 64609	28/06/2019	FRONTLINE FIRE & RESCUE EQUIPMENT	PPE EQUIPMNET FOR BUSH FIRE BRIGADES.	1	5,165.82	
INV 64610	28/06/2019	FRONTLINE FIRE & RESCUE EQUIPMENT	PPE FOR BUSHFIRE BRIGADES.	1	1,729.20	
EFT34239	13/09/2019	GRAFTON ELECTRICS	CLACKLINE FIRE SHED - REPLACE SENSOR FLOODLIGHT	1		297.61
INV 6085	01/07/2019	GRAFTON ELECTRICS	CLACKLINE FIRE SHED - REPLACE SENSOR FLOODLIGHT	1	198.61	
INV 6109	10/07/2019	GRAFTON ELECTRICS	CREATE 298. CALL BACK TO TERMINATE CABLES DUE TO MISINFORMATION FROM SHIRE.	1	99.00	
EFT34240	13/09/2019	GRIFFIN VALUATION ADVISORY	VALUATION NEWCASTLE ROAD BRIDGE NORTHAM	1		3,740.00
INV 1678	15/08/2019	GRIFFIN VALUATION ADVISORY	VALUATION NEWCASTLE ROAD BRIDGE NORTHAM	1	3,740.00	
EFT34241	13/09/2019	GROVE WESLEY DESIGN ART	TEA TOWELS	1		682.00
INV 5632	31/07/2019	GROVE WESLEY DESIGN ART	TEA TOWELS	1	682.00	
EFT34242	13/09/2019	HOLCIM AUSTRALIA PTY LTD	6M3 OF 20/20/80 SUPPLIER AND DELIVER	1		1,551.00
INV 9406491813/08/2019		HOLCIM AUSTRALIA PTY LTD	6M3 OF 20/20/80 SUPPLIER AND DELIVER	1	1,551.00	
EFT34243	13/09/2019	IXOM OPERATIONS PTY LTD	CHLORINE MONTHLY SERVICE FEE FOR TREATED WASTE WATER RETICULATION FOR THE PERIOD 01/07/2019 TO 30/06/2020 X 2 BOTTLES	1		348.50
INV 6148763	31/08/2019	IXOM OPERATIONS PTY LTD	CHLORINE MONTHLY SERVICE FEE FOR TREATED WASTE WATER RETICULATION FOR THE PERIOD 01/07/2019 TO 30/06/2020 X 2 BOTTLES	1	348.50	
EFT34244	13/09/2019	JOANNE PARFIIT	ARTIST IN RESIDENCE - JOANNE PARFIIT (7TH SEPTEMBER 2019)	1		300.00
INV 3	07/09/2019	JOANNE PARFIIT	ARTIST IN RESIDENCE - JOANNE PARFIIT (7TH SEPTEMBER 2019)	1	300.00	
EFT34245	13/09/2019	MILMAR DISTRIBUTORS	24 WHITE/YELLOW RECEIPT ROLLS	1		172.40
INV 0002317415/08/2019		MILMAR DISTRIBUTORS	24 WHITE/YELLOW RECEIPT ROLLS	1	172.40	

Ordinary Council Meeting Minutes
16 October 2019



Date: 02/10/2019
Time: 9:14:57AM

Shire of Northam

USER: Kathy Scholz
PAGE: 17

Cheque /EFT No	Date	Name	Invoice Description	Bank Code	INV Amount	Amount
EFT34246	13/09/2019	NEIL SIMPSON ENTERTAINER	ENTERTAINMENT FOR KILLARA CLIENTS	1		85.00
INV 78	05/09/2019	NEIL SIMPSON ENTERTAINER	ENTERTAINMENT FOR KILLARA CLIENTS	1	85.00	
EFT34248	13/09/2019	NORTHAM BOWLING CLUB INC	SPONSORHIP OF 2020 LADIES CLASSIC IN APRIL 2020	1		550.00
INV 7188	09/09/2019	NORTHAM BOWLING CLUB INC	SPONSORHIP OF 2020 LADIES CLASSIC IN APRIL 2020	1	550.00	
EFT34249	13/09/2019	NORTHAM FEED & HIRE	DOG & CAT FOOD AND OTHER MISCELLANEOUS ITEMS - AUGUST	1		82.50
INV 0000231930/08/2019		NORTHAM FEED & HIRE	DOG & CAT FOOD AND OTHER MISCELLANEOUS ITEMS - AUGUST	1	16.50	
INV 0000232902/09/2019		NORTHAM FEED & HIRE	DOG & CAT FOOD AND OTHER MISCELLANEOUS ITEMS - SEPTEMBER	1	16.50	
INV 0000233103/09/2019		NORTHAM FEED & HIRE	DOG & CAT FOOD AND OTHER MISCELLANEOUS ITEMS - SEPTEMBER	1	16.50	
INV 0000233003/09/2019		NORTHAM FEED & HIRE	DOG & CAT FOOD AND OTHER MISCELLANEOUS ITEMS - SEPTEMBER	1	16.50	
INV 0000233205/09/2019		NORTHAM FEED & HIRE	DOG & CAT FOOD AND OTHER MISCELLANEOUS ITEMS - SEPTEMBER	1	16.50	
EFT34250	13/09/2019	CMEGA.PEST CONTROL PTY LTD T/A STEWARTS PEST CONTROL	QUARTERLY RODENT BAITING STATION SERVICES.	1		1,299.65
INV 51469	10/05/2019	CMEGA.PEST CONTROL PTY LTD T/A STEWARTS PEST CONTROL	QUARTERLY RODENT BAITING STATION SERVICES.	1	1,299.65	
EFT34251	13/09/2019	OXTER SERVICES	BURIAL DATE 30.08.2019 NEW GRAVE FOR THE BURIAL CF MARIE OLIVE BEAZLEY	1		710.00
INV 21691	27/08/2019	OXTER SERVICES	BURIAL DATE 30.08.2019 NEW GRAVE FOR THE BURIAL CF MARIE OLIVE BEAZLEY	1	710.00	
EFT34252	13/09/2019	RAC BUSINESSWISE	RENEWAL RAC BUSINESSWISE ABSOLUTE	1		1,274.00
INV 306680	31/05/2019	RAC BUSINESSWISE	RENEWAL RAC BUSINESSWISE ABSOLUTE	1	980.00	
INV 311584	04/09/2019	RAC BUSINESSWISE	RENEWAL RAC BUSINESSWISE ABSOLUTE FOR REGO - N11114 - PN1507	1	147.00	
INV 311611	04/09/2019	RAC BUSINESSWISE	RENEWAL RAC BUSINESSWISE ABSOLUTE FOR REGO - N460 WUNDOWIE BUS - PN1220	1	147.00	
EFT34253	13/09/2019	RED DOT STORES	ITEMS FOR PCYC ROBOTICS PROGRAM	1		228.49
INV 4173753110/07/2019		RED DOT STORES	CABLE CLIPS	1	11.00	

Ordinary Council Meeting Minutes
16 October 2019



Date: 02/10/2019
Time: 9:14:57AM

Shire of Northam

USER: Kathy Scholz
PAGE: 18

Cheque /EFT No	Date	Name	Invoice Description	Bank Code	INV Amount	Amount
INV 4182593717/07/2019		RED DOT STORES	ITEMS FOR PCYC ROBOTICS PROGRAM	1	111.49	
INV 4188790222/07/2019		RED DOT STORES	PRIZES FOR SUMMER READING PROGRAM	1	40.00	
INV 4205345705/08/2019		RED DOT STORES	STORAGE BOXES FOR ITEM PROCESSING AT FRONT DESK.	1	47.00	
INV 4215757214/08/2019		RED DOT STORES	CRAFT FOR STORYTIME	1	19.00	
EFT34254	13/09/2019	ROOGENIC - ROO TEA PTY LTD	ROOGENIC PRODUCTS (MERCHANDISE)	1		1,784.25
INV INV-263215/08/2019		ROOGENIC - ROO TEA PTY LTD	ROOGENIC PRODUCTS (MERCHANDISE)	1	1,784.25	
EFT34255	13/09/2019	SPECIALISED TREE SERVICE	ANNUAL TOWNSITE PRUNING SPENCERS BROOK	1		19,884.64
INV 3137	09/09/2019	SPECIALISED TREE SERVICE	ANNUAL TOWNSITE PRUNING SPENCERS BROOK	1	17,272.14	
INV 3138	10/09/2019	SPECIALISED TREE SERVICE	ANNUAL TOWNSITE PRUNING GRASS VALLEY	1	2,612.50	
EFT34256	13/09/2019	STATE LAW PUBLISHER	GOVERNMENT GAZETTE FOR SCHEME AMENDMENT NO 14	1		437.90
INV 162623	16/08/2019	STATE LAW PUBLISHER	GOVERNMENT GAZETTE FOR SCHEME AMENDMENT NO 14	1	105.70	
INV 162622	16/08/2019	STATE LAW PUBLISHER	GOVERNMENT GAZETTE FOR SCHEME AMENDMENT NO 14	1	166.10	
INV 162604	16/08/2019	STATE LAW PUBLISHER	GOVERNMENT GAZETTE FOR SCHEME AMENDMENT NO 14	1	166.10	
EFT34257	13/09/2019	THE WORKWEAR GROUP	UNIFORMS FOR YVONNE RYDER	1		215.15
INV 1156391215/07/2019		THE WORKWEAR GROUP	UNIFORM FOR SUSAN BURLEY.	1	85.00	
INV 1157002417/07/2019		THE WORKWEAR GROUP	UNIFORMS FOR YVONNE RYDER	1	130.15	
EFT34258	13/09/2019	TURF GRASS SOLUTIONS AUSTRALIA PTY LTD	20KG BAG HUMIC COATED UREA.	1		660.00
INV 0000062306/09/2019		TURF GRASS SOLUTIONS AUSTRALIA PTY LTD	20KG BAG HUMIC COATED UREA.	1	660.00	
EFT34259	13/09/2019	WESTWIDE AUTO ELECTRICS AND AIR CONDITIONING	REPAIR AIR CONDITIONER IN FORD RANGER UTE PN1307.	1		1,417.00
INV INV-931501/07/2019		WESTWIDE AUTO ELECTRICS AND AIR CONDITIONING	REPAIR AIR CONDITIONER IN FORD RANGER UTE PN1307.	1	1,417.00	

Ordinary Council Meeting Minutes
16 October 2019



Date: 02/10/2019
Time: 9:14:57AM

Shire of Northam

USER: Kathy Scholz
PAGE: 19

Cheque /EFT No	Date	Name	Invoice Description	Bank Code	INV Amount	Amount
EFT34260	19/09/2019	COOPER & OXLEY CONSTRUCTION CO PTY LTD	CONSTRUCTION OF NEW NORTHAM AQUATIC FACILITY AS PER CONTRACT 2018-2 ESSENTIAL ELEMENTS.	1		1,681,377.83
INV 3475	13/09/2019	COOPER & OXLEY CONSTRUCTION CO PTY LTD	CONSTRUCTION OF NEW NORTHAM AQUATIC FACILITY AS PER CONTRACT 2018-2 ESSENTIAL ELEMENTS.	1	1,681,377.83	
EFT34261	23/09/2019	ABCORP AUSTRALASIA PTY LTD	3000 LIBRARY BARCODES AL4200019004B - AL2400022000CB	1		342.10
INV 29520	04/07/2019	ABCORP AUSTRALASIA PTY LTD	3000 LIBRARY BARCODES AL4200019004B - AL2400022000CB	1	342.10	
EFT34262	23/09/2019	AD BIRD ENGINEERING PTY LTD	SAFETY INSPECTION OF SPENCER BROOK ROAD AND TRIMMER ROAD AND FORREST STREET AND NEWCASTLE ROAD WITH REPORT	1		6,622.00
INV 192005	15/08/2019	AD BIRD ENGINEERING PTY LTD	SAFETY INSPECTION OF SPENCER BROOK ROAD AND TRIMMER ROAD AND FORREST STREET AND NEWCASTLE ROAD WITH REPORT	1	6,622.00	
EFT34263	23/09/2019	AG IMPLEMENTS NORTHAM PTY LTD	MAKE HYDRAULIC HOSE AS PER SAMPLE.	1		539.08
INV 372687	02/08/2019	AG IMPLEMENTS NORTHAM PTY LTD	EN1314 - REPLACE HYDRAULIC HOSE AS PER PROVIDED SAMPLE.	1	83.70	
INV 373004	08/08/2019	AG IMPLEMENTS NORTHAM PTY LTD	MAKE HYDRAULIC HOSE AS PER SAMPLE.	1	245.42	
INV 373314	16/08/2019	AG IMPLEMENTS NORTHAM PTY LTD	GRAPHITE SPRAY.	1	63.98	
INV 373422	19/08/2019	AG IMPLEMENTS NORTHAM PTY LTD	EN1705 - JOHN DEERE MOWER - DRIVING BELT - DMU210282.	1	145.98	
EFT34264	23/09/2019	ALL FLAGS SIGNS AND BANNERS	AUSTRALIAN FLAG- VISITOR CENTRE	1		605.00
INV 57988	29/07/2019	ALL FLAGS SIGNS AND BANNERS	AUSTRALIAN FLAG- VISITOR CENTRE	1	605.00	
EFT34265	23/09/2019	AMPAC DEBT RECOVERY (WA) P/L	DEBT RECOVERY FOR AUGUST 2019	1		7,566.15
INV 59005	31/08/2019	AMPAC DEBT RECOVERY (WA) P/L	DEBT RECOVERY FOR AUGUST 2019	1	7,566.15	
EFT34266	23/09/2019	AFOD PTY LTS T/A DONOVANPAYNE ARCHITECTS	PROVIDE PROJECT SUPERINTENDENT SERVICES FOR THE CONSTRUCTION OF THE NORTHAM AQUATIC CENTRE WHICH IS BEING CONSTRUCTED BY COOPER & OXLEY CONSTRUCTION CO PTY LTD.	1		58,383.00

Ordinary Council Meeting Minutes
16 October 2019



Date: 02/10/2019
Time: 9:14:57AM

Shire of Northam

USER: Kathy Scholz
PAGE: 20

Cheque /EFT No	Date	Name	Invoice Description	Bank Code	INV Amount	Amount
INV 0921	18/09/2019	APOD PTY LTS T/A DONOVAN PAYNE ARCHITECTS	PROVIDE PROJECT SUPERINTENDENT SERVICES FOR THE CONSTRUCTION OF THE NORTHAM AQUATIC CENTRE WHICH IS BEING CONSTRUCTED BY COOPER & CXLEY CONSTRUCTION CO PTY LTD.	1	58,383.00	
EFT34267	23/09/2019	APPLIED INDUSTRIAL TECHNOLOGIES T/A NORTHAM BEARINGS	FARKER RUBBER HOSE	1		520.70
INV 6360760	19/08/2019	APPLIED INDUSTRIAL TECHNOLOGIES T/A NORTHAM BEARINGS	FARKER RUBBER HOSE	1	345.03	
INV 0140621	20/08/2019	APPLIED INDUSTRIAL TECHNOLOGIES T/A NORTHAM BEARINGS	HISTOL GRIP GREASE GUN AND ATTACHMENT.	1	-177.98	
INV 6361828	20/08/2019	APPLIED INDUSTRIAL TECHNOLOGIES T/A NORTHAM BEARINGS	HISTOL GRIP GREASE GUN AND ATTACHMENT.	1	220.44	
INV 6361834	20/08/2019	APPLIED INDUSTRIAL TECHNOLOGIES T/A NORTHAM BEARINGS	HISTOL GRIP GREASE GUN AND ATTACHMENT.	1	133.21	
EFT34268	23/09/2019	AUSTRALIAN PAPER	2000 WHITE WINDOW FACED ENVELOPES	1		161.02
INV 9618979619/08/2019		AUSTRALIAN PAPER	1000 WHITE WINDOW ENVELOPES	1	70.51	
INV 9618979519/08/2019		AUSTRALIAN PAPER	2000 WHITE WINDOW FACED ENVELOPES	1	90.51	
EFT34269	23/09/2019	AUSTRALIAN SERVICES UNION	Payroll deductions	1		103.60
INV DEDUCT17/09/2019		AUSTRALIAN SERVICES UNION	Payroll deductions		103.60	
EFT34270	23/09/2019	AUSTRALIAN TAXATION OFFICE - PAYG	EAYG PAY RUN WEEK END 17/09/2019.	1		59,714.00
INV PAYG 17/17/09/2019		AUSTRALIAN TAXATION OFFICE - PAYG	EAYG PAY RUN WEEK END 17/09/2019.	1	59,714.00	
EFT34271	23/09/2019	AVON PAPER SHRED	EMPTYNG OF SHREDDER BIN - ADMIN	1		65.00
INV 1454	05/09/2019	AVON PAPER SHRED	EMPTYNG OF SHREDDER BIN - ADMIN	1	65.00	
EFT34272	23/09/2019	AVON VALLEY ARTS SOCIETY (INC)	REFUND OF BOND PAYMENT FOR BOOKING #3978	1		100.00
INV 10201	24/08/2019	AVON VALLEY ARTS SOCIETY (INC)	REFUND OF BOND PAYMENT FOR BOOKING #3978	1	100.00	
EFT34273	23/09/2019	AVON VALLEY ENVIRONMENTAL SOCIETY	GUIDED WALK (NORTHAM PRIMARY SCHOOL VISIT TO BKB 30TH JULY 2019)	1		350.00
INV 4	08/08/2019	AVON VALLEY ENVIRONMENTAL SOCIETY	GUIDED WALK (NORTHAM PRIMARY SCHOOL VISIT TO BKB 30TH JULY 2019)	1	150.00	

Ordinary Council Meeting Minutes
16 October 2019

Date: 02/10/2019
Time: 9:14:57AM

Shire of Northam

USER: Kathy Scholz
PAGE: 21

Cheque /EFT No	Date	Name	Invoice Description	Bank Code	INV Amount	Amount
INV 6	15/08/2019	AVON VALLEY ENVIRONMENTAL SOCIETY	GUIDED WALK FOR BKB SCHOOL VISIT (14/08/2019)	1	100.00	
INV 5	15/08/2019	AVON VALLEY ENVIRONMENTAL SOCIETY	GUIDED WALK FOR BKB SCHOOL VISIT (13-08-2019)	1	100.00	
EFT34274	23/09/2019	BRIDGELEY COMMUNITY CENTRE	COMMUNITY GRANTS ALLOCATION ON BEHALF OF NORTHAM CHRISTIAN MINISTERS ASSOCIATION.	1		5,500.00
INV 0000272912/09/2019		BRIDGELEY COMMUNITY CENTRE	COMMUNITY GRANTS ALLOCATION ON BEHALF OF NORTHAM CHRISTIAN MINISTERS ASSOCIATION.	1	5,500.00	
EFT34275	23/09/2019	BUZZINROUND PTY LTD T/A BR COMMS	REPROGRAM DEPOT PABX - ACTIVATE ADDITIONAL LINE & CHANGE PRIMARY EXTENSION	1		365.00
INV 0000282502/09/2019		BUZZINROUND PTY LTD T/A BR COMMS	REPROGRAM DEPOT PABX - ACTIVATE ADDITIONAL LINE & CHANGE PRIMARY EXTENSION	1	365.00	
EFT34276	23/09/2019	CADD'S FASHIONS	UNIFORM - ROB WILSON	1		334.71
INV 19-00006.22/08/2019		CADD'S FASHIONS	UNIFORM - ROB WILSON	1	334.71	
EFT34277	23/09/2019	CIVIC LEGAL	LEGAL ADVICE - JACK POTTER MATTER	1		4,363.97
INV 505564	31/08/2019	CIVIC LEGAL	ANNUAL SOLICITOR AUDIT	1	715.00	
INV 505567	31/08/2019	CIVIC LEGAL	LEGAL ADVICE - JACK POTTER MATTER	1	3,648.97	
EFT34278	23/09/2019	COATES HIRE OPERATIONS PTY LTD	AVON RIVER FESTIVAL - LIGHTING TOWERS AND GENERATORS	1		6,675.87
INV 1859248120/08/2019		COATES HIRE OPERATIONS PTY LTD	AVON RIVER FESTIVAL - LIGHTING TOWERS AND GENERATORS	1	6,675.87	
EFT34279	23/09/2019	COCA-COLA AMATIL (AUST) PTY LTD	1x 20PK 750ML PUMP WATER	1		14.12
INV 2208534805/09/2019		COCA-COLA AMATIL (AUST) PTY LTD	1x 20PK 750ML PUMP WATER	1	14.12	
EFT34280	23/09/2019	COMBINED TYRES	REPAIR REAR LEFT TYRE ON SOUTHERN BROOK 1.4 AT FIRE SHED	1		550.00
INV INV-277612/09/2019		COMBINED TYRES	REPAIR REAR LEFT TYRE ON SOUTHERN BROOK 1.4 AT FIRE SHED	1	286.00	
INV INV-285216/09/2019		COMBINED TYRES	PLEASE PLUG BACK TYRE ON PN1018 KOMASTSU LOADER AT INKPEN TIP AND QUOTE PRICE ON NEW TYRE AND FITTING	1	264.00	
EFT34281	23/09/2019	COUNTRY COPIERS NORTHAM	SERVICE CALL -HR CANON MF 729C PRINTER ERRORS	1		331.85

Ordinary Council Meeting Minutes
16 October 2019



Date: 02/10/2019
Time: 9:14:57AM

Shire of Northam

USER: Kathy Scholz
PAGE: 22

Cheque /EFT No	Date	Name	Invoice Description	Bank Code	INV Amount	Amount
INV 42816	31/07/2019	COUNTRY COPIERS NORTHAM	VC SUPPLIES	1	128.60	
INV 42816	07/08/2019	COUNTRY COPIERS NORTHAM	WHITE CARD	1	24.65	
INV 42816	21/08/2019	COUNTRY COPIERS NORTHAM	STATIONERY FOR BKB	1	46.60	
INV 57856	09/09/2019	COUNTRY COPIERS NORTHAM	SERVICICE CALL - HR CANON MF729C PRINTER ERRORS	1	132.00	
EFT34282	23/09/2019	COUNTRYWIDE PUBLICATIONS	DOUBLE PAGE SPREAD- YOUR GUIDE TO WA SPRING 2019 TO SPRING 2020	1		1,850.00
INV 27681	30/06/2019	COUNTRYWIDE PUBLICATIONS	DOUBLE PAGE SPREAD- YOUR GUIDE TO WA SPRING 2019 TO SPRING 2020	1	1,850.00	
EFT34283	23/09/2019	CROSSLAND & HARDY PTY LTD	OLD QUARRY ROAD ANNUAL VOLUMETRIC SURVEY	1		990.00
INV 0001423014/08/2019		CROSSLAND & HARDY PTY LTD	OLD QUARRY ROAD ANNUAL VOLUMETRIC SURVEY	1	990.00	
EFT34284	23/09/2019	DAWN GARLETT	REFUND FOR BOND PAYMENT BOOKING #4072	1		440.00
INV 10231	11/09/2019	DAWN GARLETT	REFUND FOR BOND PAYMENT BOOKING #4072	1	440.00	
EFT34285	23/09/2019	DEPARTMENT OF FIRE & EMERGENCY SERVICE (DFES)	2019/2020 ESL QUARTER 1 FOR ESL	1		185,352.82
INV 149480	21/08/2019	DEPARTMENT OF FIRE & EMERGENCY SERVICE (DFES)	2019/2020 ESL QUARTER 1 FOR ESL	1	185,352.82	
EFT34286	23/09/2019	DEPARTMENT OF FIRE & EMERGENCY SERVICE - DIRECT BRIGADE ALARMS	KILLARA DAY RESPITE CARE. YEARLY DFES FIRE PANEL MONITORING FROM 01 JULY 2019 TILL 30 JUNE 2020.	1		1,840.93
INV 50542	22/07/2019	DEPARTMENT OF FIRE & EMERGENCY SERVICE - DIRECT BRIGADE ALARMS	KILLARA DAY RESPITE CARE. YEARLY DFES FIRE PANEL MONITORING FROM 01 JULY 2019 TILL 30 JUNE 2020.	1	1,840.93	
EFT34287	23/09/2019	DEPARTMENT OF LOCAL GOVERNMENT, SPORT AND CULTURAL INDUSTRIES	50% ELECTRICITY CHARGES-298 FITZGERALD ST FOR 17/07/2019-21/08/2019	1		504.16
INV R102428003/09/2019		DEPARTMENT OF LOCAL GOVERNMENT, SPORT AND CULTURAL INDUSTRIES	50% ELECTRICITY CHARGES-298 FITZGERALD ST FOR 17/07/2019-21/08/2019	1	504.16	
EFT34288	23/09/2019	EASIFLEET	Payroll deductions	1		3,036.10
INV DEDUCT17/09/2019		EASIFLEET	Payroll deductions		1,421.55	
INV DEDUCT17/09/2019		EASIFLEET	Payroll deductions		1,614.55	
EFT34289	23/09/2019	EL CABALLO SOCIAL GOLF CLUB INC	SENIOR SPORT FUNDING FOR PETER BUTTFIELD	1		100.00

Ordinary Council Meeting Minutes
16 October 2019



Date: 02/10/2019
Time: 9:14:57AM

Shire of Northam

USER: Kathy Scholz
PAGE: 23

Cheque /EFT No	Date	Name	Invoice Description	Bank Code	INV Amount	Amount
INV 0000049016/09/2019		EL CABALLO SOCIAL GOLF CLUB INC	SENIOR SPORT FUNDING FOR PETER BUTTFIELD	1	100.00	
EFT34290	23/09/2019	FRANK DAVIS	DIDGERIDOO PLAYING & STORY TELLING (15TH SEPTEMBER 2019)	1		600.00
INV 2	15/09/2019	FRANK DAVIS	DIDGERIDOO PLAYING & STORY TELLING (15TH SEPTEMBER 2019)	1	300.00	
INV 3	16/09/2019	FRANK DAVIS	STORY TELLING & DIDGERIDOO PLAYING	1	300.00	
EFT34291	23/09/2019	FULTON HOGAN INDUSTRIES PTY LTD	COLD MIX & EMULTION.	1		8,338.00
INV 1313197921/08/2019		FULTON HOGAN INDUSTRIES PTY LTD	COLD MIX & EMULTION.	1	4,224.00	
INV 1314008923/08/2019		FULTON HOGAN INDUSTRIES PTY LTD	COLD MIX.	1	2,596.00	
INV 1314007823/08/2019		FULTON HOGAN INDUSTRIES PTY LTD	15LTR EMUSEAL EP2174	1	1,518.00	
EFT34292	23/09/2019	GLENN STUART BEVERIDGE	MEMORIAL HALL. SUPPLY AND INSTALL BROOM CUPBOARD TO ENTRY AREA FOR CLEANERS.	1		1,925.00
INV 95	28/08/2019	GLENN STUART BEVERIDGE	OLD TOWN ADMIN. UNBLOCK GUTTER DOWNPIPE NEAR FRONT DOOR. OLD TOWN ADMIN. UNBLOCK GUTTER DOWNPIPE NEAR FRONT DOOR.	1	198.00	
INV 96	28/08/2019	GLENN STUART BEVERIDGE	MEMORIAL HALL. SUPPLY AND INSTALL BROOM CUPBOARD TO ENTRY AREA FOR CLEANERS.	1	539.00	
INV 99	28/08/2019	GLENN STUART BEVERIDGE	FLUFFY DUCKLINGS. REPAIR REAR DOOR TIMBER TRIMS AND PAINT TO MATCH.	1	165.00	
INV 90	28/08/2019	GLENN STUART BEVERIDGE	KURINGAL VILLAGE. UNIT 7, HIGH PRESSURE WASH PAVERS AND RELAY ANY PAVERS THAT ARE TRIP HAZARDS.	1	286.00	
INV 5	09/09/2019	GLENN STUART BEVERIDGE	NORTHAM LIBRARY. REFIX LOOSE STAIR NOSING, 3RD FROM TOP ANDE CHECK ALL OTHERS.	1	99.00	
INV 6	09/09/2019	GLENN STUART BEVERIDGE	TOWN HALL. CHANGE OUT GLOBES IN FOYER AND QUOTE TO REPLACE MAIN HALL LIGHTS.	1	187.00	
INV 4	09/09/2019	GLENN STUART BEVERIDGE	MEMORIAL HALL. CLEAN OUT GUTTERS BEFORE STORM.	1	165.00	
INV 10	10/09/2019	GLENN STUART BEVERIDGE	BAKERS HILL TOILETS. RECTIFY DOOR AS NOT CLOSING PROPERLY.	1	77.00	
INV 9	11/09/2019	GLENN STUART BEVERIDGE	BERT HAWKE PAVILION. RECTIFY LIGHT POLE TO MAKE SAFE AFTER ENGINEERS REPORT.	1	209.00	
EFT34293	23/09/2019	GOLDER ASSOCIATES PTY LTD	MATERIAL TESTING IN BAKERS HILL FOR CONSTRUCTION OF BASIN AS PER QUOTE EMAIL 11.05.19	1		4,950.00

Ordinary Council Meeting Minutes
16 October 2019



Date: 02/10/2019
Time: 9:14:57AM

Shire of Northam

USER: Kathy Scholz
PAGE: 24

Cheque /EFT No	Date	Name	Invoice Description	Bank Code	INV Amount	Amount
INV 78530	05/09/2019	GOLDER ASSOCIATES PTY LTD	MATERIAL TESTING IN BAKERS HILL FOR CONSTRUCTION OF BASIN AS PER QUOTE EMAIL 11.05.19	1	4,950.00	
EFT34294	23/09/2019	GRAFTON ELECTRICS	AVON MALL. REPLACE LID TO CHARGING STATION AND MAKE SURE WATER TIGHT.	1		335.50
INV 6183	02/08/2019	GRAFTON ELECTRICS	AVON MALL. REPLACE LID TO CHARGING STATION AND MAKE SURE WATER TIGHT.	1	335.50	
EFT34295	23/09/2019	INTERNATIONAL CITIES, TOWN CENTRES AND COMMUNITIES SOCIETY INC	ICTC CONFERENCE 2019 REGISTRATION	1		1,165.00
INV 214	06/09/2019	INTERNATIONAL CITIES, TOWN CENTRES AND COMMUNITIES SOCIETY INC	ICTC CONFERENCE 2019 REGISTRATION	1	1,165.00	
EFT34296	23/09/2019	KATE MIRANDA PEARCE	RATES CREDIT REFUND FOR ASSESSMENT A12980 AT SETTLEMENT	1		252.00
INV A.12980	17/09/2019	KATE MIRANDA PEARCE	RATES CREDIT REFUND FOR ASSESSMENT A12980 AT SETTLEMENT		252.00	
EFT34297	23/09/2019	KLEENHEAT GAS	TOWN HALL. YEARLY GAS BOTTLE HIRE.	1		158.40
INV 574253	21/07/2019	KLEENHEAT GAS	TOWN HALL. YEARLY GAS BOTTLE HIRE.	1	158.40	
EFT34298	23/09/2019	LAURA PATTERSON	RATES CREDIT REFUND FOR ASSESSMENT A11801	1		759.19
INV A.11801	23/09/2019	LAURA PATTERSON	RATES CREDIT REFUND FOR ASSESSMENT A11801		759.19	
EFT34299	23/09/2019	LUCY'S TEAROOMS	2019 AVON RIVER FESTIVAL - CATERING VIP FUNCTION	1		600.00
INV 1965	02/09/2019	LUCY'S TEAROOMS	2019 AVON RIVER FESTIVAL - CATERING VIP FUNCTION	1	600.00	
EFT34300	23/09/2019	MALINOWSKI HOLDINGS PTY LTD	RENT 174 FITZGERALD STREET, NORTHAM - 01/09/2019-30/09/2019	1		916.66
INV 0000025226/08/2019		MALINOWSKI HOLDINGS PTY LTD	RENT 174 FITZGERALD STREET, NORTHAM - 01/09/2019-30/09/2019	1	916.66	
EFT34301	23/09/2019	MARKETFORCE	AVON RIVER FESTIVAL ADVERTISING 2019	1		2,697.96
INV 28833	29/07/2019	MARKETFORCE	AVON RIVER FESTIVAL ADVERTISING 2019	1	1,597.96	
INV 28833	29/07/2019	MARKETFORCE	AVON RIVER FESTIVAL- FULL PAGE SPREAD IN AVON DESCENT WRAP	1	1,100.00	
EFT34302	23/09/2019	MAYBERRY HAMMOND & CO	BEB VOLUNTEER - LEGAL ADVICE FOR PROTECTIONS UNDER ROAD TRAFFIC ACT 2000	1		1,309.11

Ordinary Council Meeting Minutes
16 October 2019



Date: 02/10/2019
Time: 9:14:57AM

Shire of Northam

USER: Kathy Scholz
PAGE: 25

Cheque /EFT No	Date	Name	Invoice Description	Bank Code	INV Amount	Amount
INV 42288	19/08/2019	MAYBERRY HAMMOND & CO	BFB VOLUNTEER - LEGAL ADVICE FOR PROTECTIONS UNDER ROAD TRAFFIC ACT 2000	1	1,309.11	
EFT34303	23/09/2019	MCLEODS BARRISTERS & SOLICITORS	ANNUAL AUDIT 2019	1		176.00
INV 109672	02/09/2019	MCLEODS BARRISTERS & SOLICITORS	ANNUAL AUDIT 2019	1	176.00	
EFT34304	23/09/2019	MICHAEL JOHN NEWTON	REIMBURSEMENT FOR STUDY TEXTBOOKS	1		105.95
INV 473740	03/09/2019	MICHAEL JOHN NEWTON	REIMBURSEMENT FOR STUDY TEXTBOOKS	1	105.95	
EFT34305	23/09/2019	MIDALIA STEEL	SUPPLY ALL ITEMS PLUS DELIVERY ON QUOTE AS ATTACHED	1		332.53
INV 6245584215/08/2019		MIDALIA STEEL	SUPPLY ALL ITEMS PLUS DELIVERY ON QUOTE AS ATTACHED	1	97.33	
INV 6244881716/08/2019		MIDALIA STEEL	SUPPLY ALL ITEMS PLUS DELIVERY ON QUOTE AS ATTACHED	1	235.20	
EFT34306	23/09/2019	MINT CIVIL PTY LTD T/A S IMMACU SWEEP	STREET SWEEPING/GULLY EDUCATION SERVICES 29/07/2019-04/08/2019	1		18,810.00
INV N2299	12/08/2019	MINT CIVIL PTY LTD T/A S IMMACU SWEEP	STREET SWEEPING/GULLY EDUCATION SERVICES 29/07/2019-04/08/2019	1	3,762.00	
INV N2300	12/08/2019	MINT CIVIL PTY LTD T/A S IMMACU SWEEP	STREET SWEEPING/GULLY EDUCATION SERVICES 05/08/2019-11/08/2019	1	3,762.00	
INV N2306	26/08/2019	MINT CIVIL PTY LTD T/A S IMMACU SWEEP	STREET SWEEPING/GULLY EDUCATION SERVICES 19/08/2019-25/08/2019	1	3,762.00	
INV N2302	26/08/2019	MINT CIVIL PTY LTD T/A S IMMACU SWEEP	STREET SWEEPING/GULLY EDUCATION SERVICES 12/08/2019-18/08/2019	1	3,762.00	
INV N2320	09/09/2019	MINT CIVIL PTY LTD T/A S IMMACU SWEEP	STREET SWEEPING/GULLY EDUCATION SERVICES 2/09/2019-08/09/2019	1	3,762.00	
EFT34307	23/09/2019	MM ELECTRICAL MERCHANDISING	POLE MOUNT METER BOX FOR WWTP.	1		78.09
INV 162753-6/13/09/2019		MM ELECTRICAL MERCHANDISING	POLE MOUNT METER BOX FOR WWTP.	1	78.09	
EFT34308	23/09/2019	MORRIS PEST AND WEED CONTROL	FIREBREAK SPRAYING -VARIOUS PROPERTIES.	1		3,749.50
INV INV-009909/09/2019		MORRIS PEST AND WEED CONTROL	BROAD LEAF SPRAY BAKERS HILL OVAL.	1	880.00	
INV INV-010011/09/2019		MORRIS PEST AND WEED CONTROL	FIREBREAK SPRAYING -VARIOUS PROPERTIES.	1	2,869.50	
EFT34309	23/09/2019	MR NATURALLY CLEAN	ADMIN BUILDING. AFTER HOURS CALL OUT ON 17/08/2019.	1		660.00

Ordinary Council Meeting Minutes
16 October 2019



Date: 02/10/2019
Time: 9:14:57AM

Shire of Northam

USER: Kathy Scholz
PAGE: 26

Cheque /EFT No	Date	Name	Invoice Description	Bank Code	INV Amount	Amount
INV INV-161720/08/2019		MR NATURALLY CLEAN	ADMIN BUILDING. AFTER HOURS CALL OUT ON 17/08/2019.	1	660.00	
EFT34311	23/09/2019	NETSIGHT	MYOSH MONTHLY SUBSCRIPTION 1/09/2019	1		671.00
INV INV-324701/09/2019		NETSIGHT	MYOSH MONTHLY SUBSCRIPTION 1/09/2019	1	671.00	
EFT34312	23/09/2019	NORTH METROPOLITAN TAFE	COURSE FEES FOR MICHAEL NEWTON - DIP CIVIL & STRUCTURAL ENGINEERING - PRODUCE BASIC CONCRETE DRAWING - USE OF STRENGTH OF MATERIALS IN E - MANAGE ENVIRONMENTAL EFFECTS	1		784.80
INV I0013560 30/08/2019		NORTH METROPOLITAN TAFE	COURSE FEES FOR MICHAEL NEWTON - DIP CIVIL & STRUCTURAL ENGINEERING - PRODUCE BASIC CONCRETE DRAWING - USE OF STRENGTH OF MATERIALS IN E - MANAGE ENVIRONMENTAL EFFECTS	1	784.80	
EFT34313	23/09/2019	NORTHAM & DISTRICTS GLASS SERVICE	REPLACE DRIVERS SIDE WINDOW IN TRUCK PN1509, N11142.	1		580.00
INV 3938	14/08/2019	NORTHAM & DISTRICTS GLASS SERVICE	REPLACE WINDSCREEN SEAL ON N11063	1	88.00	
INV 4035	30/08/2019	NORTHAM & DISTRICTS GLASS SERVICE	REPLACE DRIVERS SIDE WINDOW IN TRUCK PN1509, N11142.	1	492.00	
EFT34314	23/09/2019	NORTHAM AGRICULTURAL SOCIETY	REFUND FOR BOND PAYMENT BOOKING #3695	1		100.00
INV 10229	11/09/2019	NORTHAM AGRICULTURAL SOCIETY	REFUND FOR BOND PAYMENT BOOKING #3695	1	100.00	
EFT34315	23/09/2019	NORTHAM BETTA ELECTRICAL	KURINGAL VILLAGE, UNIT 2. SUPPLY WESTINGHOUSE FREESTANDING ELEVATED GAS STOVE AS PER QUOTE - 2001200111	1		4,332.99
INV 2001000028/03/2019		NORTHAM BETTA ELECTRICAL	MICRO SD CARDS FOR CAMERAS AND CATALOGUE COMPUTER	1	99.99	
INV 2001000402/09/2019		NORTHAM BETTA ELECTRICAL	WUNDOWIE DESKTOP COMPUTER	1	849.00	
INV 2001000404/09/2019		NORTHAM BETTA ELECTRICAL	KURINGAL VILLAGE, UNIT 2. SUPPLY WESTINGHOUSE FREESTANDING ELEVATED GAS STOVE AS PER QUOTE - 2001200111	1	1,999.00	
INV 2001000404/09/2019		NORTHAM BETTA ELECTRICAL	PORTABLE WIRELESS UHF MICROPHONE HEADSET SYSTEM	1	99.00	
INV 2001000511/09/2019		NORTHAM BETTA ELECTRICAL	NILFISK BACKPACK VACUUM CLEANER BAGS (PACK OF 5)	1	87.00	
INV 23905	13/09/2019	NORTHAM BETTA ELECTRICAL	EPSON PROJECTOR (PLUS CARRY BAG AND HDMI CORD)	1	1,199.00	

Date: 02/10/2019
Time: 9:14:57AM

Shire of Northam

USER: Kathy Scholz
PAGE: 27

Cheque /EFT No	Date	Name	Invoice Description	Bank Code	INV Amount	Amount
EFT34316	23/09/2019	NORTHAM CARPETS PTY LTD	RECREATION CENTRE - SUPPLY AND INSTALL 7 RHAPSODY SLIMLINE VENETIAN BLINDS IN UNGREY JACKS OFFICE, MEGAN'S OFFICE, POOL MAMNAGERS CFFICE, STAFF AREA, POOL MANAGERS DOOR, CFFICE/KIOSK, KIOSK DOOR	1		1,650.00
INV 145316	12/09/2019	NORTHAM CARPETS PTY LTD	RECREATION CENTRE - SUPPLY AND INSTALL 7 RHAPSODY SLIMLINE VENETIAN BLINDS IN UNGREY JACKS OFFICE, MEGAN'S OFFICE, POOL MAMNAGERS CFFICE, STAFF AREA, POOL MANAGERS DOOR, CFFICE/KIOSK, KIOSK DOOR	1	1,650.00	
EFT34317	23/09/2019	NORTHAM FLORIST	FLOWERS FOR STAFF MEMBER	1		100.00
INV 21717	05/09/2019	NORTHAM FLORIST	FLOWERS FOR STAFF MEMBER	1	100.00	
EFT34318	23/09/2019	NORTHAM LIQUOR BARONS	STOCK FOR COUNCIL CHAMBERS	1		245.95
INV 210287	21/08/2019	NORTHAM LIQUOR BARONS	STOCK FOR COUNCIL CHAMBERS	1	245.95	
EFT34319	23/09/2019	CASIS OUTDOOR STRUCTURES	SUPPLY AND INSTALL SHADE STRUCTURE AS PER SUPPLIED CONCEPT DRAWING TO COVER THE SWING SET AREA AT APEX PARK NORTHAM. QUOTE INCLUDES ENGINEERING OF DESIGN, SITE WORKS AND CONCRETE. POLES TO BE 150NB PAINTED FINISH AS PER QUOTE# QU00403. ****PLEASE NOTE POLES & SHADE SAILS TO BE THE SAME COLOUR AS THE OTHER CURRENT SHADE STRUCTURE AT APEX PARK NORTHAM.	1		15,345.00

Ordinary Council Meeting Minutes
16 October 2019



Date: 02/10/2019
Time: 9:14:57AM

Shire of Northam

USER: Kathy Scholz
PAGE: 28

Cheque /EFT No	Date	Name	Invoice Description	Bank Code	INV Amount	Amount
INV INV-044303/09/2019		CASIS OUTDOOR STRUCTURES	SUPPLY AND INSTALL SHADE STRUCTURE AS PER SUPPLIED CONCEPT DRAWING TO COVER THE SWING SET AREA AT APEX PARK NORTHAM. QUOTE INCLUDES ENGINEERING OF DESIGN, SITE WORKS AND CONCRETE. POLES TO BE 150NB PAINTED FINISH AS PER QUOTE# QU00403. ****PLEASE NOTE POLES & SHADE SAILS TO BE THE SAME COLOUR AS THE OTHER CURRENT SHADE STRUCTURE AT APEX PARK NORTHAM.	1	15,345.00	
EFT34320	23/09/2019	OSHGROUPT LTD	FITNESS FOR WORK ATTENDANCE & REPORT CASSANDRA GERICKE	1		892.24
INV 0013730321/08/2019		OSHGROUPT LTD	FITNESS FOR WORK ATTENDANCE & REPORT CASSANDRA GERICKE	1	892.24	
EFT34321	23/09/2019	OXTER SERVICES	WUNDOWIE TOILETS. SUPPLY 4 X CARTONS OF TOILET ROLLS, 1 X PINEAWAY AND 1 X DISPOSIBLE GLOVES.	1		439.09
INV 21674	26/08/2019	OXTER SERVICES	ADMIN BUILDING. SUPPLY 2 X BOXES HAND TOWEL.	1	101.44	
INV 21690	27/08/2019	OXTER SERVICES	VISITORS CENTRE. SUPPLY 4 X PACKS OF LARGE ROLLS.	1	70.84	
INV 21686	28/08/2019	OXTER SERVICES	WUNDOWIE HALL. SUPPLY 1 X BOX OF HAND TOWEL.	1	50.72	
INV 21692	30/08/2019	OXTER SERVICES	WUNDOWIE TOILETS. SUPPLY 4 X CARTONS OF TOILET ROLLS, 1 X PINEAWAY AND 1 X DISPOSIBLE GLOVES.	1	216.09	
EFT34322	23/09/2019	PROFESSIONAL LOCKSERVICE	INKPEN TIP FIRE SERVICES. SUPPLY AND DELIVER 2 X EH2 AND EH4 KEYS.	1		91.30
INV 0010397529/07/2019		PROFESSIONAL LOCKSERVICE	INKPEN TIP FIRE SERVICES. SUPPLY AND DELIVER 2 X EH2 AND EH4 KEYS.	1	91.30	
EFT34323	23/09/2019	REGIONAL BRIDGING PTY LTD	BRIDGE 0613 YILGARN AVE SHIRE ON NORTHAM. ABUTMENT #2 FULL CAP REPLACEMENT.	1		12,295.17
INV 0000019511/07/2019		REGIONAL BRIDGING PTY LTD	BRIDGE 0613 YILGARN AVE NORTHAM MAINTENANCE AND REPAIRS REPLACE ABUTMENT 2 HALFCAPS, FULL WIDTH REPLACE CORBEL PIER 3 #1 AND PIER 7 #1 & #2 INCLUDES PROPPING AND TRAFFIC MANAGEMENT.	1	4,717.62	
INV 0000019709/08/2019		REGIONAL BRIDGING PTY LTD	BRIDGE 0613 YILGARN AVE SHIRE ON NORTHAM. ABUTMENT #2 FULL CAP REPLACEMENT.	1	7,577.55	

Ordinary Council Meeting Minutes
16 October 2019



Date: 02/10/2019
Time: 9:14:57AM

Shire of Northam

USER: Kathy Scholz
PAGE: 29

Cheque /EFT No	Date	Name	Invoice Description	Bank Code	INV Amount	Amount
EFT34324	23/09/2019	REGIONAL PHYSIOTHERAPY & SPORTS INJURY CLINIC & IN BALANCE FITNESS	SENIOR SPORT FUNDING	1		792.00
INV 0038336	04/09/2019	REGIONAL PHYSIOTHERAPY & SPORTS INJURY CLINIC & IN BALANCE FITNESS	SENIOR SPORT FUNDING	1	99.00	
INV 0038400	05/09/2019	REGIONAL PHYSIOTHERAPY & SPORTS INJURY CLINIC & IN BALANCE FITNESS	SENIOR SPORT FUNDING	1	99.00	
INV 0038389	05/09/2019	REGIONAL PHYSIOTHERAPY & SPORTS INJURY CLINIC & IN BALANCE FITNESS	SENIOR SPORT FUNDING	1	99.00	
INV 0038398	05/09/2019	REGIONAL PHYSIOTHERAPY & SPORTS INJURY CLINIC & IN BALANCE FITNESS	SENIOR SPORT FUNDING	1	99.00	
INV 0038463	06/09/2019	REGIONAL PHYSIOTHERAPY & SPORTS INJURY CLINIC & IN BALANCE FITNESS	SENIOR SPORT FUNDING	1	99.00	
INV 0038566	10/09/2019	REGIONAL PHYSIOTHERAPY & SPORTS INJURY CLINIC & IN BALANCE FITNESS	SENIOR SPORT FUNDING	1	99.00	
INV 0038564	10/09/2019	REGIONAL PHYSIOTHERAPY & SPORTS INJURY CLINIC & IN BALANCE FITNESS	SENIOR SPORT FUNDING	1	99.00	
INV 0038809	16/09/2019	REGIONAL PHYSIOTHERAPY & SPORTS INJURY CLINIC & IN BALANCE FITNESS	SENIOR SPORT FUNDING FOR JACQUELINE STEAD	1	99.00	
EFT34325	23/09/2019	RIVERGUM VALLEY LAVENDER	STOCK PURCHASES FOR VISITORS CENTRE	1		340.40
INV 0000031117/09/2019		RIVERGUM VALLEY LAVENDER	STOCK PURCHASES FOR VISITORS CENTRE	1	340.40	
EFT34326	23/09/2019	SAFE T CARD AUSTRALIA PTY LTD	SAFE T CARD MONITORING FEE JULY 2019	1		924.00
INV INV-172201/07/2019		SAFE T CARD AUSTRALIA PTY LTD	SAFE T CARD MONITORING FEE JULY 2019	1	660.00	
INV INV-172201/07/2019		SAFE T CARD AUSTRALIA PTY LTD	2 X SAFE T CARDS MONITORING FEE 01-07-19 TO 30-06-2020	1	264.00	
EFT34327	23/09/2019	SMARTSENSOR TECHNOLOGIES PTY LTD T/A S SOLAR BINS AUSTRALIA	YEARLY SUBSCRIPTION FOR FIVE BIN SENSORS ON A 60 MONTH PLAN	1		783.48
INV INV-011001/08/2019		SMARTSENSOR TECHNOLOGIES PTY LTD T/A S SOLAR BINS AUSTRALIA	YEARLY SUBSCRIPTION FOR FIVE BIN SENSORS ON A 60 MONTH PLAN	1	783.48	
EFT34328	23/09/2019	SOUTHERN CROSS AUSTEREO PTY LTD	RADIO ADS- JUNE & JULY AVON RIVER FESTIVAL 2019	1		391.60
INV 7090529431/08/2019		SOUTHERN CROSS AUSTEREO PTY LTD	RADIO ADS- JUNE & JULY AVON RIVER FESTIVAL 2019	1	303.60	
INV 7090529531/08/2019		SOUTHERN CROSS AUSTEREO PTY LTD	AROUND THE TOWNS 2019/20 - SHIRE PRESIDENT INTERVIEWS	1	88.00	

Ordinary Council Meeting Minutes
16 October 2019



Date: 02/10/2019
Time: 9:14:57AM

Shire of Northam

USER: Kathy Scholz
PAGE: 30

Cheque /EFT No	Date	Name	Invoice Description	Bank Code	INV Amount	Amount
EFT34329	23/09/2019	STATE LIBRARY OF WESTERN AUSTRALIA	ANNUAL FEE FOR LOST AND DAMAGED PUBLIC LIBRARY MATERIALS 2019-2020	1		2,150.50
INV RI02378617/07/2019		STATE LIBRARY OF WESTERN AUSTRALIA	DELIVERY OF BETTER BEGINNINGS PROGRAM 2019/2020	1	610.50	
INV RI02414614/09/2019		STATE LIBRARY OF WESTERN AUSTRALIA	ANNUAL FEE FOR LOST AND DAMAGED PUBLIC LIBRARY MATERIALS 2019-2020	1	1,540.00	
EFT34330	23/09/2019	SUSAN MAE CONNELL	REFUELLING TECH OFFICERS VEHICLE PH1613 IN PERTH -NO SHELL STATIONS AVAILABLE	1		49.98
INV 20996	12/09/2019	SUSAN MAE CONNELL	REFUELLING TECH OFFICERS VEHICLE PH1613 IN PERTH -NO SHELL STATIONS AVAILABLE	1	49.98	
EFT34331	23/09/2019	THE WORKWEAR GROUP	VNECK CARDIGAN NAVY SIZE 14 - CAT51C BOBBI-JO WISE	1		288.46
INV 1165672222/08/2019		THE WORKWEAR GROUP	VNECK CARDIGAN NAVY SIZE 14 - CAT51C BOBBI-JO WISE	1	204.31	
INV 1167921828/08/2019		THE WORKWEAR GROUP	CATUST - FUSICIA RUFFLE SLEEVE - ALISON ROWLAND SIZE 12	1	84.15	
EFT34332	23/09/2019	TOLL TRANSPORT PTY LTD	FREIGHT CHARGES 19/08/2019	1		124.36
INV 1069350	25/08/2019	TOLL TRANSPORT PTY LTD	FREIGHT CHARGES 19/08/2019	1	124.36	
EFT34333	23/09/2019	TOURISM COUNCIL	JAPAN READY WORKSHOP 17/10/2019 - MICHELLE WINMAR	1		130.00
INV 0001233703/09/2019		TOURISM COUNCIL	JAPAN READY WORKSHOP 17/10/2019 - MICHELLE WINMAR	1	130.00	
EFT34334	23/09/2019	TRANSWEST WA AUSTRALIAN STONE COMPANY PTY LTD	19MM MRWA SPEC GRAVEL DELIVERED.	1		9,739.03
INV INV-029731/08/2019		TRANSWEST WA AUSTRALIAN STONE COMPANY PTY LTD	19MM MRWA SPEC GRAVEL DELIVERED.	1	9,739.03	
EFT34335	23/09/2019	VINCELEC	KILLARA RESPITE CARE. URGENT CHANGE OUT OF FAULTY LIGHTS TO LED BATTENS.	1		3,038.88
INV 1164	29/08/2019	VINCELEC	KILLARA RESPITE CARE. URGENT CHANGE OUT OF FAULTY LIGHTS TO LED BATTENS.	1	2,850.00	
INV 1169	08/09/2019	VINCELEC	REPAIR TO OLD LIGHT FITTING IN KITCHEN. REPLACE FLORESCENT TUBE WITH LED TUBE.	1	188.88	

Ordinary Council Meeting Minutes
16 October 2019



Date: 02/10/2019
Time: 9:14:57AM

Shire of Northam

USER: Kathy Scholz
PAGE: 31

Cheque /EFT No	Date	Name	Invoice Description	Bank Code	INV Amount	Amount
EFT34336	23/09/2019	VINCENT RYDER	MAKING BOOMERANG DEMONSTRATION - WATCH AND INTERACT WITH LOCAL ELDER VINCENT RYDER AS HE MAKES BOOMERANGS. (14TH SEPTEMBER 2019)	1		500.00
INV 3	06/09/2019	VINCENT RYDER	TAPPING STICK MAKING DEMONSTRATION AT BKB	1	200.00	
INV 3	14/09/2019	VINCENT RYDER	MAKING BOOMERANG DEMONSTRATION - WATCH AND INTERACT WITH LOCAL ELDER VINCENT RYDER AS HE MAKES BOOMERANGS. (14TH SEPTEMBER 2019)	1	300.00	
EFT34337	23/09/2019	WARRICKS NEWSAGENCY	MAGIZINE SUBSCRIPTIONS 01/08/2019-29/08/2019	1		392.65
INV SN0001731	07/2019	WARRICKS NEWSAGENCY	LIBRARY - MAGIZINE SUBSCRIPTIONS 04/07/2019-25/07/2019	1	148.18	
INV SN00006	02/09/2019	WARRICKS NEWSAGENCY	ADMIN - THE WEST AUSTRALIAN SEP 2019	1	83.90	
INV SN00017	02/09/2019	WARRICKS NEWSAGENCY	MAGIZINE SUBSCRIPTIONS 01/08/2019-29/08/2019	1	160.57	
EFT34338	23/09/2019	WHEATBELT OFFICE & BUSINESS MACHINES	C4847A MAGENTA CARTRIDGE	1		572.00
INV 25251	28/08/2019	WHEATBELT OFFICE & BUSINESS MACHINES	C4847A MAGENTA CARTRIDGE	1	572.00	
EFT34339	23/09/2019	WHEATBELT SAFETYWEAR	STELL CAPPED SAFETY BOOTS - JOHN BLUNDY	1		198.00
INV 8976	16/08/2019	WHEATBELT SAFETYWEAR	X6 CANS SPOT MARKING PAINT	1	48.00	
INV 8979	19/08/2019	WHEATBELT SAFETYWEAR	STELL CAPPED SAFETY BOOTS - JOHN BLUNDY	1	150.00	
EFT34340	26/09/2019	BUDGET DEVELOPMENTS AUSTRALIA	INFRASTRUCTURE BOND REFUND FOR BUILDING APPLICATION 18104.	2		1,014.86
INV T1074	26/09/2019	BUDGET DEVELOPMENTS AUSTRALIA	INFRASTRUCTURE BOND REFUND FOR BUILDING APPLICATION 18104.	2	1,014.86	
EFT34341	26/09/2019	BUILDER'S REGISTRATION BOARD OF WA	MONTHLY BSL FEES COLLECTED FOR THE BUILDING COMMISSION FOR THE MONTH OF AUGUST 2019.	2		1,118.75
INV T1080	26/09/2019	BUILDER'S REGISTRATION BOARD OF WA	MONTHLY BSL FEES COLLECTED FOR THE BUILDING COMMISSION FOR THE MONTH OF AUGUST 2019.	2	1,118.75	
EFT34342	26/09/2019	BUILDING AND CONSTRUCTION INDUSTRY TRAINING FUND	MONTHLY BCITF FEES COLLECTED FOR THE CONSTRUCTION TRAINING FUND FOR THE MONTH OF AUGUST 2019.	2		49.41

Ordinary Council Meeting Minutes
16 October 2019



Date: 02/10/2019
Time: 9:14:57AM

Shire of Northam

USER: Kathy Scholz
PAGE: 32

Cheque /EFT No	Date	Name	Invoice Description	Bank Code	INV Amount	Amount
INV T1079	26/09/2019	BUILDING AND CONSTRUCTION INDUSTRY TRAINING FUND	MONTHLY BCITF FEES COLLECTED FOR THE CONSTRUCTION TRAINING FUND FOR THE MONTH OF AUGUST 2019.	2	49.41	
EFT34343	26/09/2019	COOPER & OXLEY CONSTRUCTION CO PTY LTD	REFUND PART OF BSL FOR BLDG APPLICATION NO 19130 WHICH WAS CHARGED INCORRECTLY.	2		75.35
INV T1080	26/09/2019	COOPER & OXLEY CONSTRUCTION CO PTY LTD	REFUND PART OF BSL FOR BLDG APPLICATION NO 19130 WHICH WAS CHARGED INCORRECTLY.	2	75.35	
EFT34344	26/09/2019	WBS MODULAR PTY LTD T/A S WBS HOMES	REFUND FOR BUILDING APPLICATION 16184 FOR INFRASTRUCTURE BOND.	2		1,022.69
INV T918	26/09/2019	WBS MODULAR PTY LTD T/A S WBS HOMES	REFUND FOR BUILDING APPLICATION 16184 FOR INFRASTRUCTURE BOND.	2	1,022.69	
35204	05/09/2019	CASH	SHIRE CONTRIBUTION TO EMPLOYEE PARTING GIFT - FOR STAFF MEMBER	1		750.00
INV 0409201904/09/2019		CASH	SHIRE CONTRIBUTION TO EMPLOYEE PARTING GIFT - FOR STAFF MEMBER	1	750.00	
35205	13/09/2019	SHIRE OF NORTHAM	FOOD BUSINESS REGISTRATION HIGH RISK 32 FOR KILLARA ADULT DAY CARE & RESPITE CENTRE	1		290.00
INV 22308	19/07/2019	SHIRE OF NORTHAM	FOOD BUSINESS REGISTRATION HIGH RISK 32 FOR KILLARA ADULT DAY CARE & RESPITE CENTRE	1	290.00	
35206	13/09/2019	SHIRE OF NORTHAM SOCIAL CLUB	Payroll deductions	1		65.00
INV DEDUCT03/09/2019		SHIRE OF NORTHAM SOCIAL CLUB	Payroll deductions		65.00	
35207	13/09/2019	SYNERGY	STREET LIGHTS 05/08/2019-02/09/2019	1		36,378.50
INV 2931107314/08/2019		SYNERGY	BKB 10/07/2019-14/08/2019	1	1,988.55	
INV 7968413415/08/2019		SYNERGY	ADMIN BUILDING 18/07/2019-15/08/2019	1	1,462.30	
INV 1819945015/08/2019		SYNERGY	KILLARA NEW BUILDING 18/07/2019-15/08/2019	1	1,184.20	
INV 1585097622/08/2019		SYNERGY	BAKERS HILL FIRE STATION 25/06/2019-22/08/2019	1	167.54	
INV 1603961222/08/2019		SYNERGY	CLACKLINE FIRE SHED 25/06/2019-22/08/2019	1	133.23	
INV 3142569022/08/2019		SYNERGY	CLACKLINE POST OFFICE 26/06/2019-22/08/2019	1	237.41	
INV 2886267422/08/2019		SYNERGY	CLACKLINE HALL 25/06/2019-22/08/2019	1	125.99	
INV 9812925723/08/2019		SYNERGY	BAKERS HILL REC CENTRE 26/06/2019-23/08/2019	1	904.32	

Ordinary Council Meeting Minutes
16 October 2019



Date: 02/10/2019
Time: 9:14:57AM

Shire of Northam

USER: Kathy Scholz
PAGE: 33

Cheque /EFT No	Date	Name	Invoice Description	Bank Code	INV Amount	Amount
INV 8110290226/08/2019		SYNERGY	WUNDOWIE POOL 27/06/2019-26/08/2019	1	2,740.58	
INV 3053076126/08/2019		SYNERGY	AGED ACCOMODATION WUNDOWIE 27/06/2019-26/08/2019	1	63.14	
INV 1422759526/08/2019		SYNERGY	WUNDOWIE OVAL 27/06/2019-26/08/2019	1	337.70	
INV 4449973026/08/2019		SYNERGY	WUNDOWIE LIBRARY 27/06/2019-26/08/2019	1	961.13	
INV 9626429926/08/2019		SYNERGY	MEDICAL CENTRE WUNDOWIE 27/06/2019-26/08/2019	1	106.16	
INV 9168227526/08/2019		SYNERGY	WUNDOWIE TENNIS CLUB 27/06/2019-26/08/2019	1	117.76	
INV 3006770726/08/2019		SYNERGY	WUNDOWIE FOOTY PAVILLON 27/06/2019-26/08/2019	1	195.84	
INV 3619900326/08/2019		SYNERGY	WUNDOWIE OVAL PUMP 28/06/2019-26/08/2019	1	202.43	
INV 1640077126/08/2019		SYNERGY	WUNDOWIE DEPOT 27/06/2019-26/08/2019	1	732.06	
INV 3706392327/08/2019		SYNERGY	WUNDOWIE TOWN HALL 27/06/2019-26/08/2019	1	407.24	
INV 0353464127/08/2019		SYNERGY	HOOPER PARK GEH BAKERS HILL 28/06/2019-27/08/2019	1	167.98	
INV 9152416402/09/2019		SYNERGY	AUXILLARY LIGHTING CHARGES 01/08/2019-02/09/2019	1	139.62	
INV 1686149902/09/2019		SYNERGY	STREET LIGHTS 05/08/2019-02/09/2019	1	24,003.32	
35208	13/09/2019	TELSTRA CORPORATION	MAINLINE ACCOUNT 05/07/2019-04/08/2019	1		11,910.11
INV 2726008928/07/2019		TELSTRA CORPORATION	VARIOUS MOBILE ACCOUNTS (MAIN)	1	2,917.14	
INV 2726008910/08/2019		TELSTRA CORPORATION	BUSHFIRE BRIGADES 10/08/2019-09/09/2019	1	1,099.98	
INV 9026075012/08/2019		TELSTRA CORPORATION	MAINLINE ACCOUNT 05/07/2019-04/08/2019	1	4,557.53	
INV 6305302927/08/2019		TELSTRA CORPORATION	BAKERS HILL BFB 23/08/2019-22/09/2019	1	30.00	
INV 2726008328/08/2019		TELSTRA CORPORATION	VARIOUS MOBILE ACCOUNTS 28/08/2019-27/09/2019	1	3,155.51	
INV 2726009028/08/2019		TELSTRA CORPORATION	VEMS TRAILER & SPRINKLER SYSTEM 28/08/2019-27/09/2019	1	50.00	
INV 2726009028/08/2019		TELSTRA CORPORATION	ENGINEERING DEPOT, LIBRARY ELEVATOR & KILLARA 28/08/2019-27/09/2019	1	99.95	
35209	13/09/2019	WATER CORPORATION	STANDPIPE 10/06/2019-14/08/2019	1		5,958.55
INV 9018587816/07/2019		WATER CORPORATION	RIVERSEDGE/VISITORS CENTRE 01/07/2019-30/06/2020	1	341.26	
INV 9007892012/08/2019		WATER CORPORATION	BAKERS HILL BFB 06/06/2019-09/08/2019	1	22.81	

Ordinary Council Meeting Minutes
16 October 2019



Date: 02/10/2019
Time: 9:14:57AM

Shire of Northam

USER: Kathy Scholz
PAGE: 34

Cheque /EFT No	Date	Name	Invoice Description	Bank Code	INV Amount	Amount
INV 9007938712/08/2019		WATER CORPORATION	STANDPIPE LOCKYER RD CLACKLINE 04/06/2019-06/08/2019	1	144.44	
INV 9007892512/08/2019		WATER CORPORATION	BAKERS HILL REC CENTRE 06/06/2019-09/08/2019	1	132.24	
INV 9007891712/08/2019		WATER CORPORATION	HOPPER PARK 06/06/2019-09/08/2019	1	50.68	
INV 9007840215/08/2019		WATER CORPORATION	STANDPIPE 10/06/2019-14/08/2019	1	1,232.53	
INV 9007840216/08/2019		WATER CORPORATION	GRASS VALLEY HALL 10/06/2019-14/08/2019	1	319.28	
INV 9007943520/08/2019		WATER CORPORATION	STANDPIPE AVRO ANSON RD MOKINE 20/06/2019-19/08/2019	1	2.53	
INV 9007869121/08/2019		WATER CORPORATION	WUNDOWIE LIBRARY 24/06/2019-20/08/2019	1	112.71	
INV 9007869121/08/2019		WATER CORPORATION	FLUFFY DUCKS DAYCARE 24/06/2019-20/08/2019	1	112.53	
INV 9007869121/08/2019		WATER CORPORATION	WUNDOWIE HALL 24/06/2019-20/08/2019	1	660.93	
INV 9007868921/08/2019		WATER CORPORATION	WUNDOWIE TOILETS 24/06/2019-20/08/2019	1	128.27	
INV 9007868621/08/2019		WATER CORPORATION	WUNDOWIE YAK SHACK 24/06/2019-20/08/2019	1	20.27	
INV 9007871821/08/2019		WATER CORPORATION	RESERVE BANSKIA AVE WUNDOWIE 24/06/2019-20/08/2019	1	210.06	
INV 9007871921/08/2019		WATER CORPORATION	WUNDOWIE OVAL 24/06/2019-20/08/2019	1	212.59	
INV 9007871922/08/2019		WATER CORPORATION	WUNDOWIE DEPOT 24/06/2019-21/08/2019	1	15.20	
INV 9007872323/08/2019		WATER CORPORATION	UNIT 8/410 KURINGAL VILLAGE 24/06/2019-22/08/2019	1	258.54	
INV 9007872323/08/2019		WATER CORPORATION	UNIT 7/410 KURINGAL VILLAGE 24/06/2019-22/08/2019	1	260.56	
INV 9007872223/08/2019		WATER CORPORATION	UNIT 6/410 KURINGAL VILLAGE 24/06/2019-22/08/2019	1	253.79	
INV 9007872223/08/2019		WATER CORPORATION	UNIT 5/410 KURINGAL VILLAGE 24/06/2019-22/08/2019	1	256.76	
INV 9007872223/08/2019		WATER CORPORATION	UNIT 4/410 KURINGAL VILLAGE 24/06/2019-22/08/2019	1	256.76	
INV 9007872223/08/2019		WATER CORPORATION	UNIT 3/410 KURINGAL VILLAGE 24/06/2019-22/08/2019	1	252.30	
INV 9007872223/08/2019		WATER CORPORATION	410 KURINGAL VILLAGE 24/06/2019-22/08/2019	1	44.78	
INV 9007872223/08/2019		WATER CORPORATION	UNIT 2/410 KURINGAL VILLAGE 24/06/2019-22/08/2019	1	255.21	
INV 9007872223/08/2019		WATER CORPORATION	UNIT 1/410 KURINGAL VILLAGE 24/06/2019-22/08/2019	1	250.75	
INV 9007868530/08/2019		WATER CORPORATION	WUNDOWIE SWIMMING POOL 24/06/2019-21/08/2019	1	150.77	

Ordinary Council Meeting Minutes
16 October 2019



Date: 02/10/2019
Time: 9:14:57AM

Shire of Northam

USER: Kathy Scholz
PAGE: 35

Cheque /EFT No	Date	Name	Invoice Description	Bank Code	INV Amount	Amount
DD14195.1	03/09/2019	WA SUPER	Payroll deductions	1		25,360.37
INV SUPER	03/09/2019	WA SUPER	Superannuation contributions	1	21,364.18	
INV DEDUCT03/09/2019	03/09/2019	WA SUPER	Payroll deductions	1	2,206.47	
INV DEDUCT03/09/2019	03/09/2019	WA SUPER	Payroll deductions	1	101.14	
INV DEDUCT03/09/2019	03/09/2019	WA SUPER	Payroll deductions	1	41.57	
INV DEDUCT03/09/2019	03/09/2019	WA SUPER	Payroll deductions	1	296.14	
INV DEDUCT03/09/2019	03/09/2019	WA SUPER	Payroll deductions	1	25.00	
INV DEDUCT03/09/2019	03/09/2019	WA SUPER	Payroll deductions	1	834.00	
INV DEDUCT03/09/2019	03/09/2019	WA SUPER	Payroll deductions	1	300.04	
INV DEDUCT03/09/2019	03/09/2019	WA SUPER	Payroll deductions	1	44.01	
INV DEDUCT03/09/2019	03/09/2019	WA SUPER	Payroll deductions	1	147.82	
DD14195.2	03/09/2019	SUNSUPER	Superannuation contributions	1		700.79
INV SUPER	03/09/2019	SUNSUPER	Superannuation contributions	1	700.79	
DD14195.3	03/09/2019	MACQUARIE SUPER MANAGER	Superannuation contributions	1		136.33
INV SUPER	03/09/2019	MACQUARIE SUPER MANAGER	Superannuation contributions	1	136.33	
DD14195.4	03/09/2019	ESSENTIAL SUPER	Superannuation contributions	1		159.15
INV SUPER	03/09/2019	ESSENTIAL SUPER	Superannuation contributions	1	159.15	
DD14195.5	03/09/2019	AUSTRALIAN ETHICAL SUPER	Superannuation contributions	1		218.33
INV SUPER	03/09/2019	AUSTRALIAN ETHICAL SUPER	Superannuation contributions	1	218.33	
DD14195.6	03/09/2019	FRIME SUPER	Payroll deductions	1		444.77
INV SUPER	03/09/2019	FRIME SUPER	Superannuation contributions	1	320.65	
INV DEDUCT03/09/2019	03/09/2019	FRIME SUPER	Payroll deductions	1	124.12	
DD14195.7	03/09/2019	CNEPATH	Superannuation contributions	1		196.31

Ordinary Council Meeting Minutes
16 October 2019



Date: 02/10/2019
Time: 9:14:57AM

Shire of Northam

USER: Kathy Scholz
PAGE: 36

Cheque /EFT No	Date	Name	Invoice Description	Bank Code	INV Amount	Amount
INV SUPER	03/09/2019	CNEPATH	Superannuation contributions	1	196.31	
DD14195.8	03/09/2019	ASGARD EMPLOYEE SUPERANNUATION	Superannuation contributions	1		50.00
INV SUPER	03/09/2019	ASGARD EMPLOYEE SUPERANNUATION	Superannuation contributions	1	50.00	
DD14195.9	03/09/2019	MEDIA SUPER	Superannuation contributions	1		201.68
INV SUPER	03/09/2019	MEDIA SUPER	Superannuation contributions	1	201.68	
DD14214.1	09/09/2019	BANKWEST	ROSS RAYSON MASTERCARD 24/7/19 TO 22/8/19	1		2,058.64
INV J WHITE	09/09/2019	BANKWEST	JASON WHITEAKER MASTERCARD 24/7/19 TO 22/8/19	1	320.09	
INV C HUNT	09/09/2019	BANKWEST	CHADD HUNT MASTERCARD 24/7/19 TO 22/8/19	1	125.58	
INV C YOUNG	09/09/2019	BANKWEST	COLIN YOUNG MASTERCARD 24/7/19 TO 22/8/19	1	356.12	
INV R RAYSON	09/09/2019	BANKWEST	ROSS RAYSON MASTERCARD 24/7/19 TO 22/8/19	1	751.90	
INV B RUTTE	09/09/2019	BANKWEST	ROSS RAYSON MASTERCARD 24/7/19 TO 22/8/19	1	504.95	
DD14244.1	17/09/2019	WA SUPER	Payroll deductions	1		25,225.80
INV SUPER	17/09/2019	WA SUPER	Superannuation contributions	1	21,438.23	
INV DEDUCT	17/09/2019	WA SUPER	Payroll deductions	1	2,094.55	
INV DEDUCT	17/09/2019	WA SUPER	Payroll deductions	1	91.76	
INV DEDUCT	17/09/2019	WA SUPER	Payroll deductions	1	32.28	
INV DEDUCT	17/09/2019	WA SUPER	Payroll deductions	1	287.32	
INV DEDUCT	17/09/2019	WA SUPER	Payroll deductions	1	25.00	
INV DEDUCT	17/09/2019	WA SUPER	Payroll deductions	1	760.58	
INV DEDUCT	17/09/2019	WA SUPER	Payroll deductions	1	300.04	
INV DEDUCT	17/09/2019	WA SUPER	Payroll deductions	1	44.01	
INV DEDUCT	17/09/2019	WA SUPER	Payroll deductions	1	152.03	
DD14244.2	17/09/2019	MACQUARIE SUPER MANAGER	Superannuation contributions	1		136.33
INV SUPER	17/09/2019	MACQUARIE SUPER MANAGER	Superannuation contributions	1	136.33	

Date: 02/10/2019
Time: 9:14:57AM

Shire of Northam

USER: Kathy Scholz
PAGE: 37

Cheque /EFT No	Date	Name	Invoice Description	Bank Code	INV Amount	Amount
DD14244.3	17/09/2019	ESSENTIAL SUPER	Superannuation contributions	1		159.15
INV SUPER	17/09/2019	ESSENTIAL SUPER	Superannuation contributions	1	159.15	
DD14244.4	17/09/2019	AUSTRALIAN ETHICAL SUPER	Superannuation contributions	1		183.30
INV SUPER	17/09/2019	AUSTRALIAN ETHICAL SUPER	Superannuation contributions	1	183.30	
DD14244.5	17/09/2019	REST INDUSTRY SUPER	Superannuation contributions	1		456.65
INV SUPER	17/09/2019	REST INDUSTRY SUPER	Superannuation contributions	1	456.65	
DD14244.6	17/09/2019	FRIME SUPER	Payroll deductions	1		440.39
INV SUPER	17/09/2019	FRIME SUPER	Superannuation contributions	1	317.49	
INV DEDUCT	17/09/2019	FRIME SUPER	Payroll deductions	1	122.90	
DD14244.7	17/09/2019	CNEPATH	Superannuation contributions	1		195.23
INV SUPER	17/09/2019	CNEPATH	Superannuation contributions	1	195.23	
DD14244.8	17/09/2019	ASGARD EMPLOYEE SUPERANNUATION	Superannuation contributions	1		50.00
INV SUPER	17/09/2019	ASGARD EMPLOYEE SUPERANNUATION	Superannuation contributions	1	50.00	
DD14244.9	17/09/2019	MEDIA SUPER	Superannuation contributions	1		204.65
INV SUPER	17/09/2019	MEDIA SUPER	Superannuation contributions	1	204.65	
DD14273.1	30/09/2019	TENNANT AUSTRALIA	LEASE FEE SEPTEMBER 2019 CLEANING EQUIPMENT RECREATION CENTRE	1		1,046.85
INV SEPTEMB0	09/2019	TENNANT AUSTRALIA	LEASE FEE SEPTEMBER 2019 CLEANING EQUIPMENT RECREATION CENTRE	1	1,046.85	
DD14195.10	03/09/2019	UNISUPER	Payroll deductions	1		586.80
INV SUPER	03/09/2019	UNISUPER	Superannuation contributions	1	423.04	
INV DEDUCT	03/09/2019	UNISUPER	Payroll deductions	1	163.76	
DD14195.11	03/09/2019	CATHOLIC SUPER	Superannuation contributions	1		89.11

Ordinary Council Meeting Minutes
16 October 2019



Date: 02/10/2019
Time: 9:14:57AM

Shire of Northam

USER: Kathy Scholz
PAGE: 38

Cheque /EFT No	Date	Name	Invoice Description	Bank Code	INV Amount	Amount
INV SUPER	03/09/2019	CATHOLIC SUPER	Superannuation contributions	1	89.11	
DD14195.12	03/09/2019	AUSTRALIAN SUPER PTY LTD	Payroll deductions	1		3,024.24
INV SUPER	03/09/2019	AUSTRALIAN SUPER PTY LTD	Superannuation contributions	1	2,743.92	
INV DEDUCT	03/09/2019	AUSTRALIAN SUPER PTY LTD	Payroll deductions	1	280.32	
DD14195.13	03/09/2019	MLC NOMINEES PTY LTD	Superannuation contributions	1		228.88
INV SUPER	03/09/2019	MLC NOMINEES PTY LTD	Superannuation contributions	1	228.88	
DD14195.14	03/09/2019	HESTA SUPER FUND	Superannuation contributions	1		56.09
INV SUPER	03/09/2019	HESTA SUPER FUND	Superannuation contributions	1	56.09	
DD14195.15	03/09/2019	THE TRUSTEE FOR A E & DL WILLIAMS SUPER FUND	Superannuation contributions	1		84.98
INV SUPER	03/09/2019	THE TRUSTEE FOR A E & DL WILLIAMS SUPER FUND	Superannuation contributions	1	84.98	
DD14195.16	03/09/2019	REST INDUSTRY SUPER	Superannuation contributions	1		512.93
INV SUPER	03/09/2019	REST INDUSTRY SUPER	Superannuation contributions	1	512.93	
DD14195.17	03/09/2019	ZURICH AUSTRALIA LIMITED	Superannuation contributions	1		598.75
INV DEDUCT	03/09/2019	ZURICH AUSTRALIA LIMITED	Payroll deductions	1	167.09	
INV SUPER	03/09/2019	ZURICH AUSTRALIA LIMITED	Superannuation contributions	1	431.66	
DD14195.18	03/09/2019	IOOF PORTFOLIO SERVICE SUPERANNUATION FUND	Superannuation contributions	1		213.26
INV SUPER	03/09/2019	IOOF PORTFOLIO SERVICE SUPERANNUATION FUND	Superannuation contributions	1	213.26	
DD14195.19	03/09/2019	(THE QUEENSLAND LOCAL GOVERNMENT SUPERANNUATION BOARD) LG SUPER	Superannuation contributions	1		532.75
INV SUPER	03/09/2019	(THE QUEENSLAND LOCAL GOVERNMENT SUPERANNUATION BOARD) LG SUPER	Superannuation contributions	1	532.75	
DD14195.20	03/09/2019	AMP LIFE LIMITED	Superannuation contributions	1		741.19
INV SUPER	03/09/2019	AMP LIFE LIMITED	Superannuation contributions	1	741.19	

Ordinary Council Meeting Minutes
16 October 2019



Date: 02/10/2019
Time: 9:14:57AM

Shire of Northam

USER: Kathy Scholz
PAGE: 39

Cheque /EFT No	Date	Name	Invoice Description	Bank Code	INV Amount	Amount
DD14195.21	03/09/2019	NETWEALTH SUPERANNUATION	Superannuation contributions	1		269.04
INV SUPER	03/09/2019	NETWEALTH SUPERANNUATION	Superannuation contributions	1	269.04	
DD14195.22	03/09/2019	HOSTPLUS SUPER	Superannuation contributions	1		371.52
INV SUPER	03/09/2019	HOSTPLUS SUPER	Superannuation contributions	1	371.52	
DD14244.10	17/09/2019	UNISUPER	Payroll deductions	1		575.52
INV SUPER	17/09/2019	UNISUPER	Superannuation contributions	1	414.91	
INV DEDUCT	17/09/2019	UNISUPER	Payroll deductions	1	160.61	
DD14244.11	17/09/2019	CATHOLIC SUPER	Superannuation contributions	1		39.05
INV SUPER	17/09/2019	CATHOLIC SUPER	Superannuation contributions	1	39.05	
DD14244.12	17/09/2019	AUSTRALIAN SUPER PTY LTD	Payroll deductions	1		3,003.03
INV SUPER	17/09/2019	AUSTRALIAN SUPER PTY LTD	Superannuation contributions	1	2,722.71	
INV DEDUCT	17/09/2019	AUSTRALIAN SUPER PTY LTD	Payroll deductions	1	280.32	
DD14244.13	17/09/2019	MLC NOMINEES PTY LTD	Superannuation contributions	1		228.89
INV SUPER	17/09/2019	MLC NOMINEES PTY LTD	Superannuation contributions	1	228.89	
DD14244.14	17/09/2019	HESTA SUPER FUND	Superannuation contributions	1		61.07
INV SUPER	17/09/2019	HESTA SUPER FUND	Superannuation contributions	1	61.07	
DD14244.15	17/09/2019	THE TRUSTEE FOR A E & DL WILLIAM'S SUPER FUND	Superannuation contributions	1		83.43
INV SUPER	17/09/2019	THE TRUSTEE FOR A E & DL WILLIAM'S SUPER FUND	Superannuation contributions	1	83.43	
DD14244.16	17/09/2019	ZURICH AUSTRALIA LIMITED	Payroll deductions	1		598.75
INV SUPER	17/09/2019	ZURICH AUSTRALIA LIMITED	Superannuation contributions	1	431.66	
INV DEDUCT	17/09/2019	ZURICH AUSTRALIA LIMITED	Payroll deductions	1	167.09	

Date: 02/10/2019
Time: 9:14:57AM

Shire of Northam

USER: Kathy Scholz
PAGE: 40

Cheque /EFT No	Date	Name	Invoice Description	Bank Code	INV Amount	Amount
DD14244.17	17/09/2019	IOOF PORTFOLIO SERVICE SUPERANNUATION FUND	Superannuation contributions	1		213.74
INV SUPER	17/09/2019	IOOF PORTFOLIO SERVICE SUPERANNUATION FUND	Superannuation contributions	1	213.74	
DD14244.18	17/09/2019	(THE QUEENSLAND LOCAL GOVERNMENT SUPERANNUATION BOARD) LG SUPER	Superannuation contributions	1		538.95
INV SUPER	17/09/2019	(THE QUEENSLAND LOCAL GOVERNMENT SUPERANNUATION BOARD) LG SUPER	Superannuation contributions	1	538.95	
DD14244.19	17/09/2019	AMP LIFE LIMITED	Superannuation contributions	1		738.22
INV SUPER	17/09/2019	AMP LIFE LIMITED	Superannuation contributions	1	738.22	
DD14244.20	17/09/2019	NETWEALTH SUPERANNUATION	Superannuation contributions	1		269.04
INV SUPER	17/09/2019	NETWEALTH SUPERANNUATION	Superannuation contributions	1	269.04	
DD14244.21	17/09/2019	HOSTPLUS SUPER	Superannuation contributions	1		463.27
INV SUPER	17/09/2019	HOSTPLUS SUPER	Superannuation contributions	1	463.27	
DD14244.22	17/09/2019	SUNSUPER	Superannuation contributions	1		702.85
INV SUPER	17/09/2019	SUNSUPER	Superannuation contributions	1	702.85	

REPORT TOTALS

Bank Code	Bank Name	TOTAL
1	MUNIFUND	3,072,818.49
2	TRUST FUND	3,369.31
TOTAL		3,076,187.80

Attachment 2

Payment dates 1st of September 2019 to 30th September 2019

- Municipal Fund payment cheque numbers 35204 to 35209 Total \$55,352.16.
- Trust Fund payment cheque numbers 2061 total \$88.25

Electronic Funds Transfer

- Municipal Fund EFT34129 to EFT34339 Total \$2,945,016.26.
- Trust Fund EFT34340 to EFT34344 Total \$3,281.06.

Direct Debits Total \$72,450.07

All have been made in accordance with delegated authority reference number (M/F/F/Regs LGA 1995 S5.42).

Month	Cheques	EFT Payments	Direct Debits	Payroll	Total Payments
	2019/2020	2019/2020	2019/2020	2019/2020	2019/2020
July	\$ 206,266.12	\$ 3,308,502.03	\$ 76,110.78	\$ 432,960.90	\$ 4,023,839.83
August	\$ 49,915.44	\$ 2,828,610.12	\$ 79,487.55	\$ 455,717.69	\$ 3,413,730.80
September	\$ 55,440.41	\$ 2,948,297.32	\$ 72,450.07	\$ 429,744.94	\$ 3,505,932.74
October					\$ -
November					\$ -
December					\$ -
January					\$ -
February					\$ -
March					\$ -
April					\$ -
May					\$ -
June					\$ -
Total	\$311,621.97	\$9,085,409.47	\$228,048.40	\$1,318,423.53	\$10,943,503.37

The Following table presents all payments made for the month from Council credit cards paid by direct debit DD14214.1

Summary Credit Card Payments	\$	Total
CESM		
SUSAN KINCH - CATERING FOR OFF-ROAD DRIVING COURSE 27 JULY 19	234.30	
THE LOOSEFOOT SALOON - CATERING FOR OFF-ROAD DRIVING COURSE 28 JULY 19	166.00	
COLES -REFRESHMENTS GRASS VALLEY BFB TRAINING COURSE	65.20	
COLES -REFRESHMENTS BAKERS HILL BFB TRAINING COURSE	30.45	
SAFFRON -RIVERSEDGE REFRESHMENTS TRAINING	9.00	504.95
Executive Manager Corporate Services		
AMAYSIM AUSTRALIA MONTH FEE LIBRARY LIFT 1/8/19	10.00	
MICROSOFT MONTHLY FEES OFFICE 365 JULY/AUGUST 19	47.19	
ADOBE CREATIVE CLOUD MONTHLY FEE AUGUST/SEPTEMBER 19	290.36	
FOREIGN TRANSACTION FEE	8.57	356.12
Executive Manager Development Services		
TRINITY - ACCOMMODATION - JACKY JURMAN TRAINING	110.00	
CROISSANT EXPRESS FRAN -REFRESHMENTS	9.50	
WILSON PARKING 17/8/19	6.08	125.58
Executive Manager Community Services		
WHEATBELT OFFICE & BUSINESS MACHINES - USB & CABLE	12.60	
AVON RIVER FESTIVAL FACEBOOK BOOST	558.60	
CPP CONVENTION CENTRE - CAR PARKING	23.22	
THE MURRAY HOTEL - ACCOMMODATION TRAINING MEGAN WORTHINGTON	141.00	
FOREIGN TRANSACTION FEES	16.48	751.90
Chief Executive Officer		
CPP CONVENTION CENTRE	23.22	
NORTHAM COURT DOCUMENT - POTTER M.R.O.	141.00	
CITY OF PERTH PARKING 7/8/19	5.05	
CITY OF PERTH PARKING 7/8/19	5.05	
CITY OF PERTH PARKING 8/8/19	5.05	
RENDEZVOUS STUDIO - LOCAL GOVERNMENT WEEK	22.90	
RENDEZVOUS STUDIO - LOCAL GOVERNMENT WEEK	22.90	
APRIL 27 CAFE PTY LTD	26.40	
WILSON PARKING LOCAL GOVERNMENT WEEK	16.20	
RENDEZVOUS STUDIO - LOCAL GOVERNMENT WEEK	9.50	
WILSON PARKING 10/8/19	34.42	
CAFE YASOU 13/8/19	8.40	320.09
Total Credit Card Expenditure		\$2,058.64

CERTIFICATION OF THE PRESIDENT

I hereby certify that this schedule of account covering vouchers and electronic fund transfer payments as per above and totalling \$3,505,932.74 was submitted to the Ordinary Meeting of Council on Wednesday, 16 October 2019.



CERTIFICATION OF THE PRESIDENT

CERTIFICATE OF THE CHIEF EXECUTIVE OFFICER

This schedule of accounts paid covering vouchers \$3,505,932.74 was submitted to each member of the Council on Wednesday, 16 October 2019, has been checked and is fully supported by vouchers and invoices which are submitted herewith and which have been duly certified as to the receipt of goods and the rendition of services and as to prices, computations and casting and the amounts shown are due for payment.

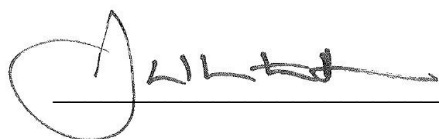

CHIEF EXECUTIVE OFFICER

12.4.2 Financial Statement for the period ending 30 September 2019

Address:	N/A
Owner:	N/A
Applicant:	N/A
File Reference:	2.1.3.4
Reporting Officer:	Zoe Macdonald, Accountant
Responsible Officer:	Colin Young, Executive Manager Corporate Services
Officer Declaration of Interest:	Nil
Voting Requirement:	Simple Majority
Press release to be issued:	No

BRIEF

For Council to receive the Financial Statement for the period ending 30 September 2019.

ATTACHMENTS

Attachment 1: Financial Statement for the period ending 30 September 2019.

A. BACKGROUND / DETAILS

The reporting of monthly financial information is a requirement under section 6.4 of the Local Government Act 1995, and Regulation 34 of the Local Government (Financial Management) Regulations.

The Statement of Financial Activity for the period ending 30 September 2019 is included as Attachment 1 to this Agenda and includes the following reports:

- Statement of Financial Activity;
- Operating Statements;
- Balance Sheet;
- Acquisition of Assets;
- Disposal of Assets;
- Information on Borrowings;
- Reserves;
- Net Current Assets;
- Rating Information

The report includes a summary of the financial position along with comments relating to the statements. If Councillors wish to discuss the report contents or

any other matters relating to this please contact Council Finance staff prior to the meeting.

Notes to the Financial Statements

Operating Income

1. **Education and Welfare is over budget by \$28,986, with Killara brokerage income of \$29,555.**
2. **Transport is over budget by 5.76% due to the receipt of unbudgeted funds from extractive industries road maintenance contribution of \$42,857.**

Operating Expenditure

3. Governance is under budget by \$92,645 due to the items presented below;
 - **Salaries and wages is under by \$19,950 due to a staff vacancy**
 - Administration allocations \$55,657 (internal non-cash)
 - **Advertising is under by \$7,671**
 - **Computer Consultancy is under by \$6,214**
 - **Printing and Stationery is under by \$6,230**
4. Recreation and culture is under budget \$77,908 due predominantly to timing of the items presented below;
 - Recreation centre maintenance \$2,195
 - Northam Town hall \$9,760
 - **Sound Shell Bernard park \$2,753**
 - Library Building maintenance \$3,377
 - **Library Programmes \$2,677**
 - **Pools and water parks \$38,865**
 - Parks Gardens and Reserves maintenance \$24,555
5. Transport is over budget by \$71,923 due to depreciation expense of \$57,120, the timing of verge maintenance is over by \$23,434.

Operating Income by Nature and Type

6. Operating grants and contributions revenue is over budget by 4% due to the item disclosed | Item 2 above.

Operating Expenditure by Nature and Type

7. Materials & Contracts is under budget 13%, related to items 3 & 4 above and roadworks maintenance timing of \$68,662.
8. Depreciation is under by \$76,221, \$69,862 being depreciation on roads and plant.

B. CONSIDERATIONS

B.1 Strategic Community / Corporate Business Plan

Theme Area 6: Governance & Leadership.

Outcome 6.3: The Shire of Northam Council is a sustainable, responsive, innovative and transparent organisation.

B.2 Financial / Resource Implications

The Financial Statements have been prepared in accordance with Council's 2019/20 Budget.

B.3 Legislative Compliance

Section 6.4 and 6.26(2)(g) of the Local Government Act.
 Local Government (Financial Management) Regulations 1996.

B.4 Policy Implications

Nil.

B.5 Stakeholder Engagement / Consultation

N/A.

B.6 Risk Implications

Risk Category	Description	Rating (consequence x likelihood)	Mitigation Action
Financial	N/A	N/A	N/A
Health & Safety	N/A	N/A	N/A
Reputation	N/A	N/A	N/A
Service Interruption	N/A	N/A	N/A
Compliance	The Report is to be presented to Council each month in order to comply with relevant legislation	Low	There are processes in place to ensure compliance with relevant legislation
Property	N/A	N/A	N/A
Environment	N/A	N/A	N/A

C. OFFICER'S COMMENT

Nil.



RECOMMENDATION / COUNCIL DECISION

Minute No: C.3787

Moved: Cr Ryan
Seconded: Cr Mencshelyi

That Council receive the Financial Statements, prepared in accordance with the Local Government (Financial Management) Regulations, for the period ending 30 September 2019.

CARRIED 6/0

The following clarification was provided prior to the Ordinary Council meeting:

Reference	Page #	Details Reference	Question	Query By	Answer
Notes	416	Operating Income - Killara brokerage	What is Killara Brokerage?	Cr Antonio	Fee paid by agencies on behalf of clients in lieu of government funding.
2. Balance Sheet	421	Non-current liabilities	Aquatic Centre Loans?	Cr Antonio	Yes, it is the portion of all Council loans that are non-current, it includes the aquatic centre loan.
2. Balance Sheet	421	Receivables	Is this due to rates being received later?	Cr Antonio	Yes, we can expect it to reduce over the coming months.
4. Disposal of Assets	427	Hino Water Truck	Unbudgeted?	Cr Antonio	Budgeted 2018/19, however sale occurred 2019/20, will be amended in the budgeted review.

Attachment 1



SHIRE OF NORTHAM MONTHLY STATEMENT OF FINANCIAL ACTIVITY FOR THE PERIOD ENDING 30 SEPTEMBER 2019

TABLE OF CONTENTS

	Page
Statement of Financial Activity	2 to 4
Notes to and Forming Part of the Statement	
1 Acquisition of Assets	5 to 8
2 Disposal of Assets	9 to 10
3 Information on Borrowings	11
4 Reserves	12
5 Net Current Assets	13
6 Rating Information	14



**SHIRE OF NORTHAM
STATEMENT OF FINANCIAL ACTIVITY
FOR THE PERIOD ENDING 30 SEPTEMBER 2019**

	NOTE	19/20 Budget \$	Ytd Budget \$	19/20 Ytd Actual \$	Variance Actuals to Budget \$	Variance Actuals to Budget %
Operating						
Revenues						
Governance		48,600	2,391	4,364	1,973	82.51%
General Purpose Funding Other		2,265,384	527,449	528,246	797	0.15%
General Purpose Funding Rates		10,417,484	10,357,878	10,357,430	(448)	(0.00%)
Law, Order, Public Safety		1,939,333	366,920	365,190	(1,730)	(0.47%)
Health		61,000	27,150	29,615	2,465	9.08%
Education and Welfare	1	1,176,072	293,680	322,666	28,986	9.87%
Housing		€2,277	15,567	16,155	588	3.77%
Community Amenities		2,704,576	1,765,144	1,764,968	(176)	(0.01%)
Recreation and Culture		2,694,010	1,307,955	1,307,265	(690)	(0.05%)
Transport	2	3,496,860	768,345	812,571	44,226	5.76%
Economic Services		598,150	99,772	106,963	7,191	7.21%
Other Property and Services		160,200	22,096	20,470	(1,626)	(7.36%)
Total Operating Revenue		25,623,946	15,554,347	15,635,902	81,555	0.52%
Expenses						
Governance	3	(1,369,648)	(417,511)	(324,866)	92,645	22.19%
General Purpose Funding		(289,104)	(106,723)	(102,318)	4,405	4.13%
Law, Order, Public Safety		(1,503,081)	(329,441)	(326,331)	3,110	0.94%
Health		(322,270)	(73,964)	(80,324)	(6,360)	(8.60%)
Education and Welfare		(1,419,060)	(340,672)	(335,177)	5,495	1.61%
Housing		(75,223)	(18,125)	(16,491)	1,634	9.02%
Community Amenities		(3,683,616)	(651,015)	(670,249)	(19,234)	(2.95%)
Recreation & Culture	4	(5,689,382)	(1,016,449)	(938,541)	77,908	7.66%
Transport	5	(5,600,997)	(1,522,820)	(1,594,743)	(71,923)	(4.72%)
Economic Services		(2,570,843)	(568,846)	(585,514)	(16,668)	(2.93%)
Other Property and Services		(47,607)	(14,114)	(115,493)	(1,379)	(1.21%)
Total Operating Expenses		(22,569,931)	(5,159,680)	(5,090,046)	69,634	1.35%
Removal of Non-Cash Items						
(Profit)/Loss on Asset Disposals		881,489	0	58,474	58,474	
Movement in Employee Benefit Provisions		(22,339)	0	(6,879)	(6,879)	
Depreciation on Assets		4,156,954	1,039,197	1,115,418	76,221	
Non Operating Items						
Purchase Land and Buildings		(2,507,264)	(148,356)	(30,458)	117,898	
Purchase Plant and Equipment		(1,546,138)	(53,403)	(1,048)	52,355	
Purchase Furniture and Equipment		(61,286)	0	0	0	
Purchase Infrastructure Assets - Roads		(3,769,439)	(1,120,698)	(468,626)	652,072	
Purchase Infrastructure Assets - Footpaths		(259,140)	0	(197)	(197)	
Purchase Infrastructure Assets - Drainage		(1,913,159)	(298,544)	(55,008)	243,536	
Purchase Infrastructure Assets - Parks & Ovals		(7,978,674)	(3,390,066)	(3,199,391)	190,675	
Purchase Infrastructure Assets - Airfields		(193,600)	(48,399)	0	48,399	
Purchase Infrastructure Assets - Streetscape		(175,000)	(41,250)	(6,890)	34,360	
Purchase Infrastructure Assets - Other		(689,265)	(55,596)	(18,288)	37,309	
Proceeds from Disposal of Assets		1,901,700	73,816	73,816	0	
Repayment of Debentures		(345,853)	(64,053)	(64,053)	0	
Proceeds from New Debentures		4,500,000	4,500,000	4,500,000	0	
Self-Supporting Loan Principal Income		22,812	0	0	0	
Transfers to Restricted Assets (Reserves)		(2,497,936)	(241,216)	(241,216)	0	
Transfers from Restricted Asset (Reserves)		2,978,239	798,527	798,527	0	
ADD Net Current Assets July 1 B/Fwd		4,463,884	4,463,884	4,463,884	0	
LESS Net Current Assets Year to Date		0	15,808,510	16,859,272	1,050,762	
Surplus/Deficit		0	0	525,191	525,191	

This statement is to be read in conjunction with the accompanying notes.

SHIRE OF NORTHAM

NOTES TO AND FORMING PART OF THE STATEMENT OF FINANCIAL ACTIVITY

FOR THE PERIOD ENDING 30 SEPTEMBER 2019

1. OPERATING STATEMENT

	Note	19/20 Budget \$	Ytd Budget	19/20 Ytd Actual \$	Variances Actuals to Budget \$	Variances Actual to Budget %
OPERATING REVENUES						
Rates		10,417,484	10,357,878	10,357,430	(448)	0%
Operating Grants Subsidies and Contributions	6	4,592,711	1,127,540	1,172,778	45,238	4%
Fees and Charges		3,848,003	2,008,710	2,042,227	33,517	2%
Interest Earnings		372,500	55,634	57,962	2,328	4%
Other Revenue		863,177	228,802	230,689	1,887	1%
TOTAL OPERATING REVENUE		20,093,875	13,778,564	13,861,086	82,522	1%
OPERATING EXPENSES						
Employee Costs		(8,363,699)	(2,041,545)	(2,028,033)	13,512	1%
Materials and Contracts	7	(7,014,040)	(1,450,057)	(1,258,159)	191,898	13%
Utility Charges		(1,000,558)	(143,048)	(141,788)	1,260	1%
Depreciation of Non Current Assets	8	(4,156,954)	(1,039,197)	(1,115,418)	(76,221)	-7%
Interest Expenses		(199,187)	(3,940)	(3,888)	52	1%
Insurance Expenses		(516,245)	(478,887)	(478,012)	875	0%
Other Expenditure		(121,759)	(3,255)	(6,273)	(3,018)	-93%
TOTAL OPERATING EXPENSE		(21,372,442)	(5,159,929)	(5,031,571)	128,358	-2%
Non Operating Grants Subsidies and Contributions		5,214,069	1,776,032	1,774,815	(1,217)	0%
Profit on Asset Disposals		318,000	0	0	0	0%
Loss on Asset Disposals		(1,199,489)	0	(58,474)	(58,474)	#DIV/0!
RESULTING FROM OPERATIONS		3,054,013	10,394,667	10,545,856	151,189	1%

SHIRE OF NORTHAM

NOTES TO AND FORMING PART OF THE STATEMENT OF FINANCIAL ACTIVITY

FOR THE PERIOD ENDING 30 SEPTEMBER 2019

2. BALANCE SHEET

	1	18/19
	YTD Actual	Actual
	\$	Estimated
		\$
CURRENT ASSETS		
Cash Assets	9,391,188	7,177,762
Receivables	13,888,187	6,036,934
Inventories	0	0
TOTAL CURRENT ASSETS	23,279,375	13,214,696
NON-CURRENT ASSETS		
Receivables	554,831	564,092
Land and Buildings	52,949,765	53,117,800
Property, Plant and Equipment	7,027,618	6,970,777
Infrastructure	163,073,650	158,573,097
TOTAL NON-CURRENT ASSETS	223,605,864	219,225,766
TOTAL ASSETS	246,885,239	232,440,462
CURRENT LIABILITIES		
Payables	1,239,492	3,384,493
Interest-bearing Liabilities	215,930	279,984
Provisions	1,200,546	1,207,424
TOTAL CURRENT LIABILITIES	2,655,968	4,871,901
NON-CURRENT LIABILITIES		
Interest-bearing Liabilities	6,500,696	2,000,696
Provisions	222,810	222,809
TOTAL NON-CURRENT LIABILITIES	6,723,506	2,223,505
TOTAL LIABILITIES	9,379,474	7,095,406
NET ASSETS	237,505,765	225,345,056
EQUITY		
Retained Surplus	119,068,177	106,350,156
Reserves - Cash Backed	4,458,576	5,015,888
Reserves - Asset Revaluation	113,979,012	113,979,012
TOTAL EQUITY	237,505,765	225,345,056



SHIRE OF NORTHAM

NOTES TO AND FORMING PART OF THE STATEMENT OF FINANCIAL ACTIVITY

FOR THE PERIOD ENDING 30 SEPTEMBER 2019

3. ACQUISITION OF ASSETS	19/20 Budget \$	19/20 Ytd Actual \$
The following assets have been acquired during the period under review:		
By Program		
Governance	Note	
Admin Building	697,500	1,056
Admin Building Solar	19,010	0
CEO Vehicle	58,000	0
New Telephone System	42,276	0
Law, Order & Public Safety		
Rangers Ute	56,220	0
3.4 Urban Fire Appliance	470,491	0
Irish Town Light Tanker	169,800	0
Clackline Kitchen, Unisex Toilet & Meeting Room	82,055	0
Bakers Hill Fire Shed	413,350	0
LED Fire Danger Rating Signs	39,450	0
Automated Weather Station	8,149	0
Water Tank Smith Road	9,800	0
CCTV Wundowie	257,166	0
SES Building Replace Sliding Door	30,320	0
Health		
Manager Health Vehicle	35,000	0
Education & Welfare		
Solar, Killara	11,300	0
Structural Repairs Memorial Hall	20,000	0
Community Amenities		
Design of Recycling Station Inkpen	40,000	9,940
Old Quarry Drainage	100,000	8,348
Rehab Investigation Old Tip Site	35,000	0
Wind Blown Waste Fence Old Quarry	25,000	0
Transfer Station Tip Shop	576,850	0
King Creek Drainage	7,150	0
Area Drainage	128,669	5,438
Planners Vehicle	35,000	0
Minson Avenue Streetscape	165,000	0
CBD Streetscape	0	6,890
Duracote Doors Bernard Park	5,100	0
Recoat Floor Bernard Park	16,385	0

SHIRE OF NORTHAM

NOTES TO AND FORMING PART OF THE STATEMENT OF FINANCIAL ACTIVITY

FOR THE PERIOD ENDING 30 SEPTEMBER 2019

3. ACQUISITION OF ASSETS (Continued)	Note	19/20 Budget \$	19/20 Ytd Actual \$
<u>By Program (Continued)</u>			
Recreation & Culture			
Wundowie Hall, Solar, Replace Ceiling, Toilet		19,950	0
Southern Brook Hall, New Ceiling, A/C to Kitchen		6,700	0
Northam Hall, New Curtain & Track		10,000	0
Wundowie Pool Solar		30,360	0
Wundowie Pool Bowl Repainting		10,000	0
Northam Aquatic Facility		6,961,942	2,755,686
Bert Hawke Pavilion - Upgrade, Including Kitchen C/fwd		40,000	0
Rec Centre, Roller Shutters & Remark Floor, CCTV		80,760	24,947
Solar Recreation Centre		38,130	0
Jubilee Oval Upgrade Electric Boards		40,750	0
Community Plan Implementation		90,000	0
Bert Hawke - Drainage C/fwd		40,000	0
Bert Hawke - Lighting C/fwd		20,000	4,097
POS Playground Improvements		122,920	13,950
Northam Youth Space		210,859	29,376
Northam Youth Space Programed Maintenance		26,500	1,031
Artificial Hockey Turf		414,453	395,251
Bridge Crossing Fixings C/fwd		10,000	0
St Johns Ambulance Site Improvements		80,000	0
Wundowie Family Space		50,000	0
Southern Brook Hall Nature Playground		42,000	0
General Library Upgrades, DAP, Paint interior, Solar, CCTV		121,054	1,111
AVVVA - Drainage Works		22,850	498
AVVVA - Roof Replacement C/fwd		145,000	0
Old Railway Station, Exit Gates & Ceiling Fans		18,500	0
Transport			
Northam Depot Redesign		10,000	0
Install Light and Pole Rear Shed Wundowie		3,500	0
Solar Northam Depot		11,300	0
Fitzgerald Footpath		60,280	0
Hovea Footpath		91,960	0
Balga Footpath		74,950	0
Wattle Crescent		31,950	197
Drainage - Rural Including WANDRRA		1,665,338	49,570
Spencers Brook Road SLK 5400 - 7360		142,000	269,042
Spencers Brook Road SLK 8650 - 10250		555,892	6,068
Spencers Brook Road 12000 - 12800		334,623	2,060
Zamia Terrance (0 - 480)		61,835	0
Chidlow Street West (360 - 670)		27,000	0
Coates Road (0 - 1700)		71,400	0
Vivan Street (0-200)		21,939	0

SHIRE OF NORTHAM

NOTES TO AND FORMING PART OF THE STATEMENT OF FINANCIAL ACTIVITY

FOR THE PERIOD ENDING 30 SEPTEMBER 2019

3. ACQUISITION OF ASSETS (Continued)	Note	19/20 Budget	19/20 Ytd Actual
Transport		\$	\$
Qualup Place (0 - 140)		15,102	0
Boondine Road (0-640)		70,345	0
Katrine Road		66,000	0
Tamma (1100 - 2400)		58,506	0
Chidlow Street West (20 - 300)		51,915	0
Chidlow Street West (1480 - 1950)		33,675	0
Park Lane (0 - 230)		31,548	0
Carlin Road (2740 - 3550)		50,537	82
Carter Street (200 - 410)		67,980	0
Ord Street (0 - 190)		15,310	0
Irishtown Road (0 - 10000)		159,078	1,212
Maintenance Capitalised		100,000	1,015
Coates Road		135,706	0
O'Neill Road		175,092	177,427
Charles Street (510 - 1070)		83,054	2,304
Kennedy Street (320 - 920)		54,563	0
Henty Place (0 - 270)		58,408	0
Martin Street (0 - 300)		70,909	0
Southern Brook Road (0 - 3070)		536,382	2,600
Laneway Land Acquisition		32,000	0
Keane Street		22,000	0
Spencers Brook Road (16430 - 19340)		473,164	0
Gravel Resheeting		87,000	0
Kerb Renewal		109,238	6,817
Culvert Renewal		84,238	0
Kubota F3680 NS Front Mower, Canopy & Catcher		47,100	0
Bobcat Attachment		15,000	0
Volvo BL71 Backhoe		87,141	0
Fuso Canter 4 Tonne Tipper Truck with Hiab Crane		82,701	0
Isuzu MLR 200 Tipper Manual		82,701	0
Dynapac Vibro Ride on Roller		51,372	0
Bobcat Trailer 4500kg		25,000	0
Honda Four Wheel Motor Cycle		23,090	0
Tandem Trailer		15,250	0
Pegasus 200 Verge Mower		15,510	0
Toyota Hilux workmate 2.7l		26,040	0
Mazda BT50T-top		26,041	0
Mitsubishi Outland Diesel 7 Seat		35,000	0
Holden Trail Blazer 7 Seat Diesel		45,000	0
Rock Bucket		10,000	0

SHIRE OF NORTHAM

NOTES TO AND FORMING PART OF THE STATEMENT OF FINANCIAL ACTIVITY

FOR THE PERIOD ENDING 30 SEPTEMBER 2019

3. ACQUISITION OF ASSETS (Continued)	Note	19/20 Budget \$	19/20 Ytd Actual \$
<u>By Program (Continued)</u>			
Transport			
Upgrade Runway		193,600	0
Economic Services			
Solar Visitor Centre		11,300	0
Signage Tower GEH Mitchell Avenue		10,000	0
Clark Street Water Metre		8,950	0
Water Pump Station Upgrade		169,681	1,048
Bakers Drainage		25,000	0
BKB Building		75,000	2,845
		19,092,963	3,779,905

SHIRE OF NORTHAM

NOTES TO AND FORMING PART OF THE STATEMENT OF FINANCIAL ACTIVITY

FOR THE PERIOD ENDING 30 SEPTEMBER 2019

3. ACQUISITION OF ASSETS (Continued)	Note	19/20 Budget \$	19/20 Ytd Actual \$
<u>By Class</u>			
Land Held for Resale		0	0
Land and Buildings		2,507,264	30,458
Plant and Equipment		1,546,138	1,048
Furniture and Equipment		61,286	0
Bush Fire Equipment		0	0
Playground Equipment		0	0
Infrastructure Assets - Roads		3,769,439	468,626
Infrastructure Assets - Footpaths		259,140	197
Infrastructure Assets - Bridges & Culverts		0	0
Infrastructure Assets - Drainage		1,913,157	55,008
Infrastructure Assets - Parks & Ovals		7,978,674	3,199,391
Infrastructure Assets - Airfields		193,600	0
Infrastructure Assets - Streetscape		175,000	6,890
Infrastructure Assets - Other		689,265	18,288
		19,092,963	3,779,905



SHIRE OF NORTHAM

NOTES TO AND FORMING PART OF THE STATEMENT OF FINANCIAL ACTIVITY
FOR THE PERIOD ENDING 30 SEPTEMBER 2019

4. DISPOSALS OF ASSETS

The following assets have been disposed of during the period under review:

By Program	Written Down Value		Sale Proceeds		Profit(Loss)	
	19/20 Budget \$	Ytd Actual \$	19/20 Budget \$	Ytd Actual \$	19/20 Budget \$	Ytd Actual \$
Governance						
CEO Vehicle	37,360	0	30,000	0	(7,360)	0
Law Order & Public Safety						
PN 1514 Rangers Triton Ute	15,162	0	12,000	0	(3,162)	0
Health						
Manager Health Vehicle	19,015	0	15,000	0	(4,015)	0
Killarra Commuter Bus C/fwd					0	0
Community Amenities						
Manager Planning	20,176	0	17,000	0	(3,176)	0
Recreation & Culture						
Victoria Street Oval	2,046,800	0	969,000	0	(1,077,800)	0
Sale of Land, Yilgarn Ave	406,500	0	724,500	0	318,000	0
Transport						
Kubota F3680 NS Front Mower, Canopy & Catche	12,823	0	7,000	0	(5,823)	0
Bobcat Attachment	3,000	0	3,000	0	0	0
Volvo BL71 Backhoe	75,068	0	17,000	0	(58,068)	0
Fuso Canter 4 Tonne Tipper Truck with Hiab Cran	30,342	0	22,000	0	(8,342)	0
Isuzu MLR 200 Tipper Manual	33,333	0	20,000	0	(13,333)	0
Dynapac Vibro Ride on Roller	3,402	0	2,000	0	(1,402)	0
Bobcat Trailer 4500kg	6,157	0	1,000	0	(5,157)	0
Honda Four Wheel Motor Cycle	1,790	0	200	0	(1,590)	0
Toyota Hilux workmate 2.7l	11,219	0	11,000	0	(219)	0
Mazda BT50T-top	14,230	0	9,000	0	(5,230)	0
Mitsubishi Outland Diesel 7 Seat	21,221	0	18,000	0	(3,221)	0
Hino Water Truck PN1501		132,290		73,816		(58,474)
Rock Bucket	25,591	0	24,000	0	(1,591)	0
	2,783,189	132,290	1,901,700	73,816	(881,489)	(58,474)



SHIRE OF NORTHAM

NOTES TO AND FORMING PART OF THE STATEMENT OF FINANCIAL ACTIVITY
FOR THE PERIOD ENDING 30 SEPTEMBER 2019

4. DISPOSALS OF ASSETS

The following assets have been disposed of during the period under review:

By Class	Written Down Value		Sale Proceeds		Profit(Loss)	
	19/20 Budget \$	Ytd Actual \$	19/20 Budget \$	Ytd Actual \$	19/20 Budget \$	Ytd Actual \$
Plant & Equipment						
CEO Vehicle	37,360	0	30,000	0	(7,360)	0
PN1514 Rangers Triton Ute 4*4	15,162	0	12,000	0	(3,162)	0
Manager Health Vehicle	19,015	0	15,000	0	(4,015)	0
Manager Planning	20,176	0	17,000	0	(3,176)	0
Kubota F3680 NS Front Mower, Canopy & Catcher	12,823	0	7,000	0	(5,823)	0
Bobcat Attachment	3,000	0	3,000	0	0	0
Volvo BL71 Backhoe	75,068	0	17,000	0	(58,068)	0
Fuso Canter 4 Tonne Tipper Truck with Hiab Cran	30,342	0	22,000	0	(8,342)	0
Isuzu MLR 200 Tipper Manual	33,333	0	20,000	0	(13,333)	0
Dynapac Vibro Ride on Roller	3,402	0	2,000	0	(1,402)	0
Bobcat Trailer 4500kg	6,157	0	1,000	0	(5,157)	0
Honda Four Wheel Motor Cycle	1,790	0	200	0	(1,590)	0
Toyota Hilux workmate 2.7i	11,219	0	11,000	0	(219)	0
Mazda BT50T-top	14,230	0	9,000	0	(5,230)	0
Mitsubishi Outland Diesel 7 Seat	21,221	0	18,000	0	(3,221)	0
Hino Water Truck PN1501		132,290		73,816		(58,474)
Rock Bucket	25,591	0	24,000	0	(1,591)	0
Land						
Sale of Land, Yilgarn Ave	406,500	0	724,500	0	318,000	0
Victoria Street Oval	2,046,800	0	969,000	0	(1,077,800)	0
	2,783,189	132,290	1,901,700	73,816	(881,489)	(58,474)
					19/20 Budget \$	Ytd Actual \$
Summary						
Profit on Asset Disposals					318,000	0
Loss on Asset Disposals					(1,199,489)	(58,474)
					(881,489)	(58,474)



SHIRE OF NORTHAM

NOTES TO AND FORMING PART OF THE STATEMENT OF FINANCIAL ACTIVITY

FOR THE PERIOD ENDING 30 SEPTEMBER 2019

5 INFORMATION ON BORROWINGS

(a) Debenture Repayments

Particulars	Principal 1-Jul-19	New Loans		Principal Repayments		Principal Outstanding		Interest Repayments	
		19/20 Budget \$	19/20 Ytd Actual \$	19/20 Budget \$	19/20 Ytd Actual \$	19/20 Budget \$	19/20 Ytd Actual \$	19/20 Budget \$	19/20 Ytd Actual \$
Recreation & Culture									
Loan 208 - Northam Country Club **	7.36%	3,238	0	0	3,238	0	3,238	153	(53)
Loan 219A - Northam Bowling Club **	3.18%	163,040	0	0	19,575	0	143,465	8,854	0
Loan 223 - Recreation Facilities	6.06%	130,049	0	0	130,049	64,053	0	65,996	10,136
Loan 224 - Recreation Facilities	6.48%	816,395	0	0	46,765	0	769,630	816,395	57,285
Loan 227 - Youth Space		500,000	0	0	45,097	0	454,903	500,000	12,110
New - Swimming Pool		0	4,500,000	4,500,000	€2,868	0	4,437,132	4,500,000	58,868
Economic Services									
Loan 225 - Victoria Oval Purchase	6.48%	667,960	0	0	38,262	0	629,698	667,960	51,781
		2,280,682	4,500,000	4,500,000	345,854	64,053	6,434,828	6,716,629	199,187
									3,888

Note: ** indicates self - supporting loans

All other debenture repayments are to be financed by general purpose revenue.

Loan 221 - No longer a self supporting loan to Northam Aero Club now financed by general purpose revenue.



SHIRE OF NORTHAM

NOTES TO AND FORMING PART OF THE STATEMENT OF FINANCIAL ACTIVITY

FOR THE PERIOD ENDING 30 SEPTEMBER 2019

	19/20 Budget				Total	19/20 Ytd Actual				
	Opening Bal	Interest	Tfr To Reserve	Tfr From Reserve		Opening Bal	Interest	Tfr To Reserve	Tfr From Reserve	
6. RESERVES - CASH BACKED										
Employee Liability Reserve	427,796	10,234		(32,574)	405,456	427,796	1,854		(32,574)	397,076
Aged Accommodation Reserve	227,403	5,440	5,000	-	237,843	227,403	1,031			228,434
Housing Reserve	265,507	6,352		-	271,859	265,507	1,204			266,711
Office Equipment Reserve	74,735	1788		(42,276)	34,247	74,735	616			75,351
Plant & Equipment Reserve	126,838	3,034	230,000	(240,000)	119,872	126,838	549	220,000	(230,000)	117,387
Road & Bridgeworks Reserve	89,498	2,141	200,000	-	291,639	89,498	406			89,904
Refuse Site Reserve	627,552	15,014	120,000	(266,850)	495,716	627,552	2,846			630,398
Regional Development Reserve	73,599	1,761		(50,000)	25,360	73,599	334			73,933
Speedway Reserve	147,600	3,531		-	151,131	147,600	669			148,269
Community Bus Replacement Reserve	2,414	58	15,000	-	17,472	2,414	11			2,425
Septage Pond Reserve	267,085	6,390		(58,643)	214,832	267,085	1,211			268,296
Killara Reserve	276,579	6,617	4,000	(59,643)	227,553	276,579	1,254			277,833
Stormwater Drainage Projects Reserve	33,593	804		-	34,397	33,593	152			33,745
Recreation and Community Facilities Reserve	584,376	13,981	1,193,500	(1,209,953)	581,904	584,376	1,685		(364,453)	221,608
Administration Office Reserve	685,801	16,407	300,000	(697,500)	304,708	685,801	2,833			688,634
Council Buildings & Amenities Reserve	348,744	8,343	290,436	(211,850)	435,673	348,744	1,167		(156,500)	193,411
River Management Reserve	360,240	8,618		(20,000)	348,858	360,240	1,634			361,874
Parking Facilities Construction Reserve	216,138	5,171		(65,000)	156,309	216,138	980			217,118
Art Collection Reserve	23,205	555		-	23,760	23,205	105			23,310
Reticulation Scheme Reserve	80,662	1,930	10,000	(8,950)	83,642	80,662	366			81,028
Election Reserve	15,165	363		(15,000)	528	15,165	29		(15,000)	194
Revaluation Reserve	61,351	1,468	10,000	-	72,819	61,351	278			61,629
Total Cash Backed Reserves	5,015,881	120,000	2,377,936	(2,978,239)	4,535,578	5,015,881	21,216	220,000	(798,527)	4,458,570
Total Interest										2,497,936

All of the above reserve accounts are to be supported by money held in financial institutions.



SHIRE OF NORTHAM

NOTES TO AND FORMING PART OF THE STATEMENT OF FINANCIAL ACTIVITY

FOR THE PERIOD ENDING 30 SEPTEMBER 2019

	19/20 Budget	19/20 Ytd Actual	Estimated 18/19 Financial Report
	\$	\$	\$
7. NET CURRENT ASSETS			
Composition of Estimated Net Current Asset Position			
CURRENT ASSETS			
Cash - Unrestricted	842,676	4,932,612	3,025,328
Cash - Restricted Unspent Grants	0	0	0
Cash - Restricted Reserves	4,535,578	4,458,576	5,015,881
Self Supporting Loan	25,095	15,147	7,516
Receivables	2,915,065	316,963	6,041,034
Rates - Current		10,882,171	0
Pensioners Rates Rebate	0	251,064	0
Provision for Doubtful Debts		(131,842)	0
GST Receivable	0	250,160	0
Accrued Income/Prepayments	0	2,304,524	0
Inventories	1,000	0	1,224
	<u>8,319,414</u>	<u>23,279,375</u>	<u>14,090,982</u>
LESS: CURRENT LIABILITIES			
	<u>(4,825,204)</u>	<u>(2,655,891)</u>	<u>(5,491,301)</u>
NET CURRENT ASSET POSITION	3,494,210	20,623,483	8,599,681
Less: Cash - Reserves - Restricted	(4,535,578)	(4,458,576)	(5,015,881)
Add: Current Loan Liability	385,911	215,930	202,288
Add: Leave Liability Reserve	405,457	228,434	427,796
Add: Budgeted Leave	250,000	250,000	250,000
ESTIMATED SURPLUS/(DEFICIENCY) C/FWD	<u>0</u>	<u>16,859,272</u>	<u>4,463,884</u>

**SHIRE OF NORTHAM
 RATING REPORT
 FOR THE PERIOD ENDED 30 September 2019**

	2011/12	2012/13	2013/14	2014/15	2015/16	2016/17	2017/18	2018/19	2019/20
Key Rating Dates									
<i>RATES ISSUED</i>	08/08/2011	5/08/2012	4/09/2013	14/08/14	14/08/15	19/08/2016	1/08/2017	15/08/2018	4/09/2019
<i>RATES DUE</i>	22/09/2011	24/09/2012	23/10/2013	8/10/2014	25/09/2015	30/09/2016	14/09/2017	19/09/2018	9/10/2019
<i>2nd INSTALMENT DUE</i>	22/11/2011	16/11/2012	23/12/2013	8/12/2014	25/11/2015	30/11/2016	14/11/2017	19/11/2018	9/12/2019
<i>3rd INSTALMENT DUE</i>	23/01/2012	29/01/2013	24/02/2014	9/02/2015	25/01/2016	30/01/2017	15/01/2018	21/01/2018	10/02/2020
<i>4th INSTALMENT DUE</i>	22/03/2012	29/03/2013	24/04/2014	9/04/2015	28/03/2016	30/03/2017	15/03/2018	21/03/2018	14/04/2020
<i>Outstanding 1st July</i>	\$521,194	\$562,531	\$568,647	\$716,120	\$873,686	\$1,116,220	\$1,483,688	\$1,535,793	\$1,737,187
<i>Rates Levied</i>	\$6,851,706	\$7,312,029	\$7,758,147	\$8,222,616	\$8,552,189	\$8,931,257	\$9,564,551	\$9,925,046	\$10,342,585
<i>Interest, Ex gratia, interim and back rates less writeoff's</i>	\$63,079	\$68,857	\$73,630	\$80,154	\$83,173	\$208,077	\$205,216	\$474,784	\$27,585
Rates Paid by month									
1 July	51,948	38,805	47,443	62,554	29,105	43,333	60,002	94,638	87,543
2 August	1,120,912	1,043,163	23,961	119,840	700,198	367,776	2,054,983	1,856,869	213,195
3 September	3,251,815	3,604,324	1,152,416	2,650,420	4,519,842	4,243,288	3,764,731	4,014,835	2,829,221
4 October									
5 November									
6 December									
7 January									
8 February									
9 March									
10 April									
11 May									
12 June									
Total YTD	4,424,675	4,686,292	1,223,819	2,832,814	5,249,146	4,654,396	5,879,716	5,966,342	3,129,960
% Ytd Rates Outstanding	40.5%	41.0%	85.4%	68.6%	44.8%	54.6%	47.8%	50.0%	74.1%
Ytd Outstanding	3,011,305	3,257,126	7,176,604	6,186,075	4,259,901	5,601,159	5,373,738	5,969,282	8,977,398

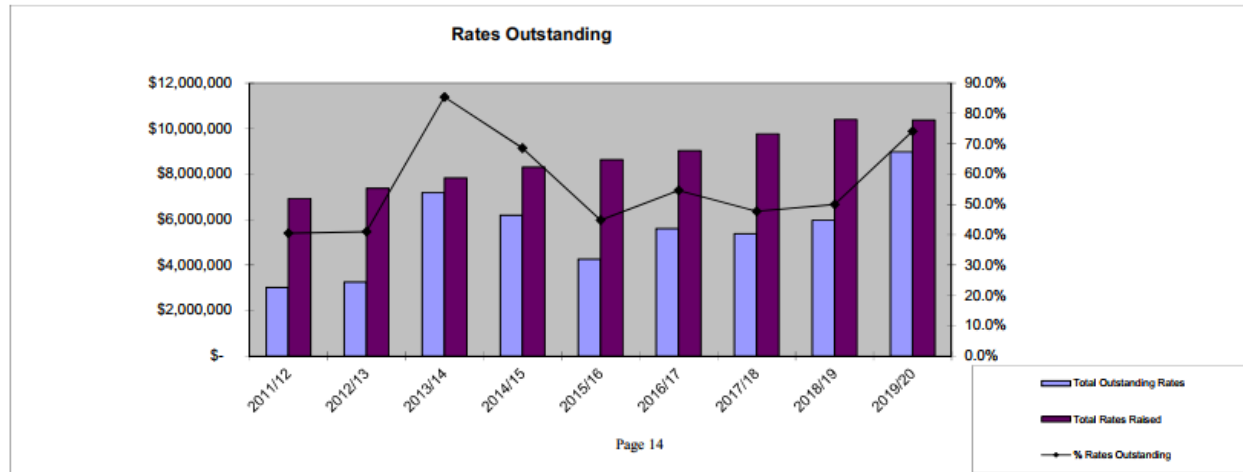

12.4.3 Lease of A322 Fluffy Ducklings Day Care

Address:	Portion of Reserve 24259 (Lot 158)
Owner:	Shire of Northam
Applicant:	Regional Early Education and Development
File Reference:	A322
Reporting Officer:	Cheryl Greenough, Coordinator Governance/Administration
Responsible Officer:	Colin Young, Executive Manager Corporate Services
Officer Declaration of Interest:	Nil
Voting Requirement:	Simple Majority
Press release to be issued:	No

BRIEF

For Council to consider allowing Fluffy Ducklings Day Care Inc. to relinquish their lease agreement, and allow Regional Early Education and Development Inc. (REED) to commence a 10 year lease for Lot 158 number 47 Boronia Avenue, Wundowie.

ATTACHMENTS

Attachment 1: Letter from REED.
Attachment 2: Letter from Fluffy Ducklings.

A. BACKGROUND / DETAILS

Fluffy Ducklings have held a peppercorn lease with the Shire of Northam going back prior to 2003 to provide day care facilities for the Wundowie Community.

Through studies and surveys it was identified there was a need in the Wheatbelt for access to early childhood education and in January 2015 a small-scale project group identified a range of management models that could be applicable for early childhood services in the Wheatbelt.

REED and Fluffy Ducklings have discussed ways to continue providing the service and sustainability needs for the community of Wundowie.

REED head office is in Narrogin, and have commenced the process for transitioning many early childhood groups to REED, with each group establishing a local Family Advisory Group.

B. CONSIDERATIONS

B.1 Strategic Community / Corporate Business Plan

Theme Area 2: Community Wellbeing

Outcome 2.1: People in the Shire of Northam feel that their community is caring and inclusive.

Objectives: Residents are well informed about activities and services in the Shire;
Services targeted at parent support and building stronger families are available; and

B.2 Financial / Resource Implications

Nil

B.3 Legislative Compliance

Local Government Act 1995 and Reg 30 Local Government (Functions and General) Regulations 1996.

B.4 Policy Implications

A8.4 (2) Management of Council Property Leases

2.0 Community Based Not-for-profit Lease: Reg 30(2)(b)

The basic principles considered in establishing a standard lease fee reflects a fair and equitable contribution of provision of a facility, the venue's pattern of use, location and the potential to obtain Community Grants assistance, as follows:

- 2.1 The Shire levy an annual administration rent equivalent to the cost of building insurance, to all community, sport and recreation groups, not including the abovementioned Community Halls, and is reviewed annually.
- 2.2 Lessees or Licensees will be responsible for the full cost of the lease document preparation, registration and other costs associated with the execution of the agreement.
- 2.3 Lessees or Licensees must agree with Council to manage the "Demised Premises" on behalf of the community and to offer a service to the community that provides a net benefit.
- 2.4 The Lessee or Licensee will be responsible for the payment of outgoings, operating costs, and minor maintenance obligations.
- 2.5 The Lessee or Licensee will not be responsible for Shire land rates, but will be responsible for rubbish service rates.
- 2.6 The Shire will insure the "Demised Premises" at replacement value and pass on the cost to the Lessee as per 2.1. The Shire will perform any structural repairs, improvements and maintenance in accordance with levels determined within its budget forecast.

- 2.7 In the case of the Lessee or Licensee who leases a Council building and obtains approval to carry out extensions, alterations and/or additions, Council will insure the improvements as part of its insurance portfolio at replacement value.
- 2.8 The Lessee or Licensee will be responsible for contents insurance for their contents, and also hold public liability for their activities and workers compensation insurance for their employees (if applicable) to the value stipulated in the agreement.
- 2.9 The Lessee or Licensee will be responsible for the cost of repair of any internal damage, vandalism, corrective maintenance or damage to external doors, glass windows, security lighting and any other external facility through misuse by a club representative, member or guest. The Shire may carry out any corrective works and recoup the full cost from the Lessee.
- 2.10 The Lessee or Licensee will be responsible for keeping the building clean and tidy at levels predetermined within the agreement.
- 2.11 The Lessee or Licensee will not incur any costs for property damage excluding contents occasioned by fire, fusion, explosion, lightning, civil commotion, storm, tempest, or earthquake.
- 2.12 On an annual basis, Lessees and Shire representatives will meet to carry out a property inspection to determine the extent to which the Lessee or Licensee have met their lease/licence obligation and to consider any specified building maintenance schedules for the following twelve month period within the Shire's budget parameters.

B.5 Stakeholder Engagement / Consultation

The Shire has had several discussions with the Manager of Fluffy Ducklings and also the management of REED.

B.6 Risk Implications

Risk Category	Description	Rating (consequence x likelihood)	Mitigation Action
Financial	N/A	N/A	N/A
Health & Safety	N/A	N/A	N/A
Reputation	Non provision of appropriate services	Low (1)	Provide a lease agreement giving stability
Service Interruption	N/A	N/A	N/A
Compliance	Non-adherence to SON policies	Low (1)	Comply with policies
Property	Under utilising property	Low (1)	Lease to community groups who would most benefit.
Environment	N/A	N/A	N/A

C. OFFICER'S COMMENT

Wheatbelt families have a right to access quality Early Childhood Education and Care services that promote children's development, enable parents to work, study or volunteer, and contribute to the social and economic wellbeing of communities and the region.

REED is a not-for-profit organisation and operate with the highest standards of governance and effective, skilled management and delivers financially viable services which are sustainable into the future and are flexible.

REED's intention is to manage the administration side of Fluffy Ducklings and retain Fluffy Ducklings staff to provide the service to the children and community.

REED is a user pays Not for Profit service and families who access the childcare facility pay a daily fee. Depending on the family income this fee may attract a child care subsidy (CCS) from the Commonwealth government. This is consistent with the arrangement currently in place with Fluffy Ducklings.

RECOMMENDATION / COUNCIL DECISION

Minute No: C.3788

Moved: Cr Little

Seconded: Cr Ryan

That Council:

- 1. Authorise the Chief Executive Officer to terminate the lease agreement between the Shire of Northam and Fluffy Ducklings Day Care Inc.**
- 2. Commence a new lease for a portion of Reserve 24259 to Regional Early Education and Development Inc. for a period of 10 years, with a 10 year renewal option in a Peppercorn Lease for \$1 per annum with the Lessee paying the building insurance in accordance with Policy A8.4 Management of Council Property Leases clause 2; and**
- 3. Authorise the Chief Executive Officer and Shire President to execute a lease agreement under the Common Seal.**

CARRIED 6/0

Attachment 1



Dear Chris

You would be aware that Regional Early Education and Development Inc (REED) has been in discussion with the Early Childhood and Education (ECEC) Service in your town to transfer the Approved Provider status to REED.

This decision is consistent with the Wheatbelt Early Childhood Education and Care (ECEC) Sustainability Project to ensure that ECEC services:

- continue to be provided across the Wheatbelt Region for the benefit of children and their families, communities and the economy,
- are sustainable and deliver high quality programs which contribute to children's development in their critical early years.

In order to affect the transfer of Approved Provider, the Department of Communities Education and Care Regulatory Unit (ECRU) requires evidence that REED has access to long term secure accommodation. Usually this evidence takes the form of a copy of a signed lease agreement. However, recognising the significance of the project that REED is undertaking, and that the majority of existing leases are between the current ECEC service and their relevant local government agency, ECRU have agreed to waive the requirement of a formal lease subject to providing a signed authority recognising the intent of the local government agency to enter into a long term lease arrangement.

This concession recognises the need to progress the transfer of Approved Provider as quickly as possible while acknowledging that leases held with local government organisations often require authorisation from the relevant Council and can be beholden to formal meeting schedules.

It would be appreciated if you could sign and return at your earliest convenience, the statement provided below, indicating the intention of the Shire to enter into a long term lease with REED. This will be submitted as part of the package to ECRU and help ensure Approved Provider transfers can be expedited.

Should you have any queries about this request I invite you to contact Philippa Gardener, REED's consultant on leasing matters, via email at philippa@bordernet.com.au or telephone 0402 017 424.

REED staff look forward to continuing to work with you to secure the lease as we continue on the path to establishing a more sustainable ECEC service across the Wheatbelt.

Yours sincerely

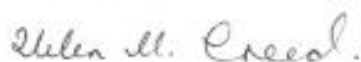

Helen Creed
Chairperson
Regional Early Education and Development

20 May 2019



Attachment 2

The Fluffy Ducklings Day Care Inc.

Corner of Boronia & Banksia Avenue
Wundowie WA 6560
Ph: 08 9573 6380
Email: Thefluffyducklingsdaycareinc@gmail.com

Mr Jason Whiteaker
Chief Executive Officer
Shire of Northam
Post Office Box 613
NORTHAM WA 6401

Via email: ceo@northam.wa.gov.au

19th September 2019

Dear Mr Whiteaker,

Work is progressing for The Fluffy Ducklings Day Care Centre to merge with Regional Early Education and Development (REED) Inc. This merger is designed to ensure the sustainability of early childcare services within the town of Wundowie.

To facilitate the merger, it is important that REED Inc be able to continue to utilise the premises currently leased to The Fluffy Ducklings by the Shire of Northam.

As requested by Cheryl Greenough this letter provides confirmation that The Fluffy Ducklings Day Care Centre Committee supports the transfer of the lease with existing conditions and is happy to relinquish its current lease so that a new lease can be entered into with REED Inc.

Yours sincerely

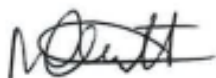

Melissa Elliott
Vice Chairperson / Director
The Fluffy Ducklings Day Care Centre

12.4.4 Adoption of Local Laws 2019

Address:	N/A
Owner:	Shire of Northam
Applicant:	Internal
File Reference:	2.3.2.15
Reporting Officer:	Cheryl Greenough, Coordinator Governance / Administration
Responsible Officer:	Colin Young, Executive Manager Corporate Services
Officer Declaration of Interest:	Nil
Voting Requirement:	Absolute Majority
Press release to be issued:	No

BRIEF

For Council to adopt the following local laws as presented at this Council meeting or very close to the local law as presented in accordance with s3.12(4)

ATTACHMENTS

- Attachment 1: Cat Local Law 2019.
- Attachment 2: Fencing Local Law 2019.
- Attachment 3: Parking Local Law 2019.

A. BACKGROUND / DETAILS

Every eight years the local laws must be reviewed in accordance with the section 3.16 of the Local Government Act 1995. The three local laws presented will become local laws once they have been Gazetted and approved by the Joint Standing Committee on Delegated Legislation.

There are two more local laws to be dealt with which will finalise the local law review until it is considered that a local law needs to be reviewed or the next eight year review becomes due.

B. CONSIDERATIONS

B.1 Strategic Community / Corporate Business Plan

Theme Area 4: Environment & Heritage.

Outcome 4.3: Residents and organisations within the Shire of Northam are supported to reduce their environmental impact.

Objective: Sustainable waste management with the aim of reducing and reusing waste effectively.

Theme Area 6: Governance and Leadership.

Outcome 6.3: The Shire of Northam council is a sustainable, responsive, innovative and transparent organisation.

Objective: Maintain a high standard of corporate governance.

B.2 Financial / Resource Implications

The *Government Gazette* pricing per page is \$165.35, there are a total of 80 pages making the cost approximately \$13,228 for the three local laws.

B.3 Legislative Compliance

Local Government Act 1995 section 3.12

(4) *After the last day for submissions, the local government is to consider any submissions made and may make the local law* as proposed or make a local law* that is not significantly different from what was proposed.*

** Absolute majority required.*

(5) *After making the local law, the local government is to publish it in the Gazette and give a copy of it to the Minister and, if another Minister administers the Act under which the local law is proposed to be made, to that other Minister.*

(6) *After the local law has been published in the Gazette the local government is to give local public notice —*
(a) *stating the title of the local law; and*
(b) *summarizing the purpose and effect of the local law (specifying the day on which it comes into operation); and*
(c) *advising that the local law is published on the local government's official website and that copies of the local law may be inspected at or obtained from the local government's office.*

B.4 Policy Implications

N/A

B.5 Stakeholder Engagement / Consultation

Six weeks consultation was advertised on 24 July 2019 in the West Australian and the local newspaper and expired on 6 September 2019. Consultation has taken place internally with Councillors and staff.

B.6 Risk Implications

Risk Category	Description	Rating (consequence x likelihood)	Mitigation Action
Financial	\$13,338	Minor (2)	Ensure compliance with the Act
Health & Safety	N/A	N/A	N/A
Reputation	N/A	N/A	N/A
Service Interruption	N/A	N/A	N/A
Compliance	Not completing local laws would create non-compliance issues	Medium (3)	Comply with all legislation
Property	N/A	N/A	N/A
Environment	N/A	N/A	N/A

C. OFFICER'S COMMENT

At this meeting there will only be three local laws considered for adoption as the Waste Local Law and the Pest Plant Local Law have not yet been considered by the relevant Ministers, and the Shire is awaiting their comments.

The following changes were suggested to the Cat Local law, the Fencing Local law and the Parking Local Law by the Department of Local Government, Sport and Cultural Industries:

Cat Local Law

Clause 1.2 'Purpose and Effect' has been removed as it is considered of no value to include Purpose and effect within the local law. Schedule 3 has been deleted.

1. Review the definition of 'nuisance' as the Act doesn't define 'nuisance' and it would be questionable if the local law could redefine the common law meaning to include the killing of native fauna.
2. In clause 2.3 delete paragraph (d) and remove 'or any other incorporated animal welfare organisation' from paragraph (a).
3. Clause 3.2 'Impounding of cats' ensure you remain within section 27 of the Cat Act 2011 by taking out 'prohibited areas' and insert 'public places' and include lawfully enter into any premises.
4. In clause 4.11(1) include a time for the variation such as 7 days after the date of notice.
5. Clause 5.7 make the first part subclause (1) then include subclause (2)-(2) Notwithstanding subclause (1) any entry into private property is subject to the Act.

Fencing Local Law

Clause 1.3 'Purpose and Effect' has been removed as it is considered of no value to include Purpose and effect within the local law.

1. Remove the Dividing Fences Act from the title as the power to make these local laws rests entirely with the Local Government Act 1995.
2. In clause 7.3 'Substantial Compliance with Forms' the words 'substantially in' should be removed as the Local Government (Functions and General) Regulations 1996 does not provide leniency for notices and must comply with the prescribed forms.

Parking Local Law

1. Check the Traffic Code for the definition of Taxi.
2. Clause 3.14 is unnecessary as it is covered in clause 2.1
3. Clause 5.11 Prohibition of Driving on Verge - This clause may potentially be raised as an issue by the Delegated Legislation Committee. This is because:
 - It does not specify how the local government's approval should be obtained; and
 - It restricts the common law right for the public (and home owners) to drive over verges for the purposes of accessing the property beyond the verge.

The Shire may wish to consider removing this clause or limiting its scope.

4. Clause 7.8 – to be consistent add '(3) The powers of the local government to remove and impound vehicles are set out in Part 3 Division 3 Subdivision 4 of the Act.'
5. Remove Schedule 3 – Parking Stations as there are none to insert.
6. Minor edits.

All changes to the above local laws have been made in accordance with the Departments suggestions.

RECOMMENDATION / COUNCIL DECISION

Minute No: C.3789

Moved: Cr Williams

Seconded: Cr Ryan

That Council adopt the following local laws as presented or not significantly different to those presented.

- **Cat Local law 2019**
- **Fencing Local Law 2019**
- **Parking Local Law 2019**

**CARRIED 6/0
BY ABSOLUTE MAJORITY**

Attachment 1

**CAT ACT 2011
LOCAL GOVERNMENT ACT 1995**

**SHIRE OF NORTHAM
CAT LOCAL LAW 2019**

Cat Act 2011
Local Government Act 1995

SHIRE OF NORTHAM
CAT LOCAL LAW 2019

Contents

PART 1 – PRELIMINARY	4
1.1 Title	4
1.2 Commencement	4
1.3 Repeal	4
1.4 Application	4
1.5 Interpretation	4
PART 2 – NUMBER OF CATS THAT MAY BE KEPT	6
2.1 Interpretation	6
2.2 Standard number of cats	6
2.3 Cats to which an approval is required	6
2.4 Application for approval	7
2.5 Determining an application	7
2.6 Conditions	7
2.7 Renewal of an application	8
2.8 Transfer of an approval	8
2.9 Variation or cancellation of an approval	8
PART 3 – CONTROL OF CATS.....	8
3.1 Cat nuisance.....	8
3.2 Cats in other places.....	9
3.3 Cleanliness.....	9
PART 4 – DESIGNATED CAT MANAGEMENT FACILITIES	9
4.1 Operating a Cat Management Facility without a licence.....	9
4.2 Application for a licence to be designated as a Cat Management Facility	9
4.3 Determination of an application	9
4.4 Where applications cannot be approved	10
4.5 Conditions of approval	10
4.6 Compliance with conditions of approval	10
4.7 Fees	10
4.8 Exemption from requirement to pay fees	10
4.9 Form of licence.....	11
4.10 Period of licence	11
4.11 Variation or cancellation of licence.....	11
4.12 Transfer.....	11

4.13	Notification.....	12
4.14	Inspection of Cat Management Facility	12
4.15	Record Keeping.....	12
PART 5 – MISCELLANEOUS		12
<i>Division 1 – General.....</i>		<i>12</i>
5.1	Pound	12
5.2	Pound Fees	12
5.3	Fees and Charges	12
5.4	False or Misleading Statement.....	12
5.5	Offence to fail to comply with notice	12
5.6	Local government may undertake requirements of notice	13
<i>Division 2 - Right of Appeal and Review</i>		<i>13</i>
5.7	Appeal and review rights.....	13
PART 6 - ENFORCEMENT.....		13
6.1	Offences and Penalties.....	13
6.2	Modified Penalties and Offence Description	13
6.3	Form of notices.....	14
SCHEDULE 1 – APPLICATION FOR A LICENCE FOR A DESIGNATED CAT MANAGEMENT FACILITY		15
SCHEDULE 2 – MINIMUM CONDITIONS OF A DESIGNATED CAT MANAGEMENT FACILITY		17
SCHEDULE 3 - OFFENCES AND MODIFIED PENALTIES		19

CAT ACT 2011
LOCAL GOVERNMENT ACT 1995

SHIRE OF NORTHAM

CAT LOCAL LAW 2019

Under the powers conferred by the *Cat Act 2011* and *Local Government Act 1995* and under all other powers enabling it, the Council of the Shire of Northam resolved on2019 to make the following local law.

PART 1 – PRELIMINARY

1.1 Title

This local law may be cited as the *Shire of Northam Cat Local Law 2019*.

1.2 Commencement

This local law comes into operation 14 days after the date of publication in the *Government Gazette*.

1.3 Repeal

- (1) The *Shire of Northam Keeping and Control of Cats Local Law 2008* published in the *Government Gazette* on 16 September 2008 and all amendments thereto are hereby repealed on the day this local law comes into operation.
- (2) Where a policy was made or adopted by the local government under or in relation to a local law repealed by this local law, then the policy is to be taken to no longer have any effect on and from the commencement day.
- (3) The local government may resolve that notwithstanding subclause (2), specified policies continue, or are to be taken to have continued, to have effect on and from the commencement day.

1.4 Application

This local law applies throughout the District.

1.5 Interpretation

- (1) In this local law, unless the context otherwise requires —

Act means the *Cat Act 2011*;

animal establishment has the meaning given to the term in the Local Planning Scheme;

applicant means the owner or occupier of the premises who makes an application for a permit under this local law;

application means an application for approval granted under this local law;

approved person means the person to whom an approval is granted under this local law;

approved cattery means any premises which are the subject of a valid planning approval under a Scheme or which is a non-conforming use that may continue under a Scheme;

Authorised Person means a person authorised by the local government under section 9.10 of the *Local Government Act 1995* to perform any of the functions of an Authorised Person under this local law;

cat means an animal of the species *felis catus* or a hybrid of that species;

Cat Management Facility means running/operating a business for boarding cats for monetary gain as per the Act.

cattery means any premises where more than 4 cats are boarded, housed or trained temporarily, usually for profit, or the personal use of numerous cats,

CEO means the Chief Executive Officer of the Shire of Northam;

Council means the Council of the Shire of Northam;

district means the district of the local government;

infringement notice means the notice referred to in clause 6.3;

infringement withdrawal notice means the notice referred to in clause 6.3;

keeper in relation to a cat means each of the following—

- (a) the owner of the cat as defined in the Act;
- (b) a person who has or appears to have immediate custody or control of the cat;
- (c) a person who keeps the cat, or has the cat in her or his possession for the time being;
- (d) a person who occupies any premises in which a cat is ordinarily kept or permitted to live and who has care and control of the cat;
- (e) A permit holder of a permit which relates to the cat; or
- (f) the holder of an exemption issued in relation to the cat.

licence means a Cat Management Facility licence issued under this local law;

licensee means the holder of a licence issued under this local law;

LG Act means the *Local Government Act 1995*;

local government means the Shire of Northam;

local planning scheme means a local planning scheme of the local government under the *Planning and Development Act 2005*, or a local planning scheme which was made under the *Planning and Development (Local Planning Schemes) Regulations 2015*;

nuisance means —

- (a) An activity or condition which is harmful or annoying and gives rise to legal liability in the tort of public or private nuisance at law;
- (b) An unreasonable interference with the use and enjoyment of a person of their ownership or occupation of land; or

- (c) interference which causes material damage to land or other property on the land affected by the interference.

premises, in addition to the meaning given to it in section 3 of the Act, means the premises described in the application to be licensed as a Cat Management Facility;

person means any person, company, public body, association or body of persons corporate or unincorporated and includes an owner, occupier, licensee and permit holder, but does not include the local government;

Regulations means the *Cat Regulations 2012*;

RSPCA means the Royal Society for the Prevention of Cruelty to Animals (Inc) of Western Australia;

Schedule means a Schedule to this local law;

transferee means a person who applies for the transfer of a licence to him or her under clause 4.12;

vermin means rats, mice, flies, fleas, mites, cockroaches and any other animal, whether vertebrate or invertebrate, which is known to be a vector of disease or likely to cause damage to human food, habitation or possessions; and

written law has the same meaning given to it by section 5 of the *Interpretation Act 1984* and includes this local law.

- (2) A term that is used in this local law and is not defined in subclause (1) has the same meaning given to it in the Act or, if not defined in the Act, the same meaning given to it in the *Cat Regulations 2012*, the *Cat (Uniform Local Provisions) Regulations 2013* or the *Local Government Act 1995*.

PART 2 – NUMBER OF CATS THAT MAY BE KEPT

2.1 Interpretation

For the purposes of applying this Part, a cat does not include a cat less than 6 months old.

2.2 Standard number of cats

Subject to clause 2.3 and the *Cat (Uniform Local Provisions) Regulations 2013*, no more than two cats may be kept on premises at which a member of a cat organisation is not ordinarily resident.

2.3 Cats to which an approval is required

- (1) Subject to subclause (2) and the *Cat (Uniform Local Provisions) Regulations 2013* a person is required to have an approval—
- (a) to keep more than two cats on any premises; or
 - (b) to use any premises as a cattery.
- (2) An approval is not required under subclause (1) if the premises concerned are –
- (a) a refuge of the RSPCA;
 - (b) a cat management facility which has been approved by the local government;
 - (c) a veterinary surgery;

2.4 Application for approval

- (1) An application for approval to keep an additional number of cats at prescribed premises is dealt with in regulation 8 of the *Cat (Uniform Local Provisions) Regulations 2013*; and
- (2) An application for approval must be accompanied by the application fee determined by the local government from time to time.

2.5 Determining an application

- (1) For the purposes of determining whether to grant approval for an application to keep an additional number of cats at prescribed premises, the local government must have regard to—
 - (a) the suitability of the zoning of the premises under the local planning scheme which applies to the premises for the use;
 - (b) the physical suitability of the premises for the proposed use;
 - (c) the environmental sensitivity and general nature of the location surrounding the premises for the proposed use;
 - (d) the structural suitability of any enclosure in which any cat is to be kept;
 - (e) the likelihood of a cat causing a nuisance, inconvenience or annoyance to an occupier of adjoining land;
 - (f) the likely effect on the amenity of the surrounding area of the proposed use;
 - (g) the likely effect on the local environment including any pollution or other environmental damage, which may be caused by the proposed use;
 - (h) any other factors which the local government considers to be relevant in the circumstances of the application; and
 - (i) any submissions received under subclause (2) within the time specified in subclause (2).
- (2) The local government may—
 - (a) consult with adjoining landowners; and
 - (b) advise the adjoining landowners that they may make submissions to the local government on the application for the approval within 14 days of receiving that advice, before determining the application for the permit.
- (3) The local government may—
 - (a) approve an application for a permit in which case it shall approve it subject to the conditions in clause 2.6 and may approve it subject to any other conditions it considers fit; or
 - (b) refuse to approve the application for an approval.
- (4) If the local government approves an application under subclause (3), then it shall issue to the applicant an approval in the form determined by the CEO.
- (5) If the local government refuses to approve an application under subclause (3), then it is to advise the applicant accordingly in writing.

2.6 Conditions

- (1) For the purpose of ensuring that the premises to which an application relates are suitable for the additional number of cats, the local government may impose any condition that it considers to be reasonably necessary for that purpose, including—
 - (a) that each cat on the premises to which the approval relates shall be registered under the Act;
 - (b) that the premises shall be maintained in good order and in a clean and sanitary condition;
 - (c) that the premises must have adequate enclosures;
 - (d) that there must be adequate space for the exercise of the cats;

- (e) that, in the case of multiple dwellings where there is no suitable dividing fence, each current occupier of the adjoining multiple dwellings must give their written consent to the approval; and
 - (f) that, without the consent of the local government, the approved person must not substitute or replace any cat that dies or is permanently removed from the premises.
- (2) A person who does not comply with a condition of the approval, commits an offence.

2.7 Renewal of an application

- (1) An application is to be renewed if–
- (a) the approved person has not breached the conditions of the approval;
 - (b) the approval would have been granted if a fresh application for an approval had been made; and
 - (c) the renewal fee is paid in full, imposed and determined by the local government under sections 6.16 to 6.19 of the *Local Government Act 1995*.
- (2) On the renewal of an approval, the conditions of the approval that applied immediately before the renewal continue to have effect.

2.8 Transfer of an approval

- (1) An approval relates only to the premises specified in the approval, and only to the approved person specified in the approval, and is transferrable only in accordance with clause 4.12.
- (2) An application for the transfer of an approval from the approved person to another person must be–
- (a) made in the form determined by the CEO;
 - (b) made by the proposed transferee;
 - (c) made with the consent of the approved person; and
 - (d) lodged with the local government together with the fee for the application for the transfer of an approval that is imposed and determined by the local government under sections 6.16 to 6.19 of the *Local Government Act 1995*.

2.9 Variation or cancellation of an approval

- (1) The local government may, at any time, vary the conditions of an approval by giving written notice to the approved person and specifying the date on which the changes will become effective.
- (2) The local government may cancel an approval–
- (a) on the request of the approved person;
 - (b) if the approved person breaches the Act, the Regulations, the *Cat (Uniform Local Provisions) Regulations 2013* or this local law; or
 - (c) if the approved person is not a fit and proper person to provide for the health and welfare of the cats.
- (3) If an approval is cancelled, the fee paid for the approval is not refundable for the term of the approval that has not yet expired.

PART 3 – CONTROL OF CATS

3.1 Cat nuisance

The owner or occupier of premises on which a cat is ordinarily kept must take reasonable measures to prevent the cat from creating a nuisance on other premises, to another person or exposing another person to health and/ or safety risk.

3.2 Cats in other places

- (1) A cat shall not be in a public place unless the cat is, in the opinion of an Authorised Person, under effective control.
- (2) If a cat is at any time in contravention of clause 3.2(1)–
 - (a) the keeper of the cat commits an offence; and
 - (b) an Authorised Person may seize and impound the cat and deal with the cat pursuant to the Act.
- (3) A cat shall not be in a place that is not a public place unless –
 - (a) consent to its being there has been given by the occupier, or a person apparently authorised to consent on behalf of the occupier; and
 - (b) it is under effective control.
- (4) If a cat is at any time, in a place in contravention of the Shire of Northam Cat Local Law 2019–
 - (a) The keeper of the cat commits an offence; and
 - (b) In any premises lawfully entered by an Authorised Person, they may seize and impound the cat and deal with the cat pursuant to the Act.

3.3 Cleanliness

The owner or occupier of a premises where a cat or cats are kept must take reasonable measures to—

- (a) keep the premises free from excrement, filth, food waste and all other matter that is likely to become offensive or injurious to health or to attract vermin;
- (b) when so directed by an Authorised Person, clean and disinfect the premises; and
- (c) keep the premises, so far as possible, free of flies and when directed by an Authorised Person, spray the premises with a residual insecticide or use any other effective means to kill and repel flies.

PART 4 – DESIGNATED CAT MANAGEMENT FACILITIES

4.1 Operating a Cat Management Facility without a licence

Unless exempt as an organisation listed in the Regulations, a person who operates a premises as a Cat Management Facility within the District without a licence commits an offence.

4.2 Application for a licence to be designated as a Cat Management Facility

An application for a licence must be made in the form of that in Schedule 1, and must be lodged with the local government together with—

- (a) plans and specifications of the premises, including a site plan;
- (b) proposed details of how the facility will be kept secure;
- (c) written evidence that either the applicant or another person who will have the charge of the cats, will reside on the premises or, in the opinion of the local government, sufficiently close to the premises so as to control the cats and ensure their health and welfare;
- (d) a written acknowledgement that the applicant has read and agrees to comply with any code of practise relating to the keeping of cats which may be nominated from time to time by the local government; and
- (e) the fee for the application for a licence referred to in clause 4.7(1).

4.3 Determination of an application

In determining an application to be designated as a Cat Management Facility, the local government is to have regard to—

- (a) the matters referred to in clause 4.4;
- (b) any written submissions received on the proposed use of the premises;
- (c) the effect which the Cat Management Facility may have on the environment or amenity of the neighbourhood;
- (d) whether the Cat Management Facility will create a nuisance for the owners and occupiers of adjoining premises; and
- (e) whether or not the imposition of and compliance with appropriate conditions of a licence will mitigate any adverse effects of the Cat Management Facility identified in the preceding paragraphs.

4.4 Where applications cannot be approved

The local government cannot approve an application for a licence where–

- (a) the facility is proposed to be located in an area where an animal establishment is not a permitted use under the Local Planning Scheme; or
- (b) an applicant or another person who will have the charge of the cats will not reside on the premises, or, in the opinion of the local government, sufficiently close to the premises so as to control the cats and so as to ensure their health and welfare.

4.5 Conditions of approval

- (1) The local government may approve an application for a licence subject to the conditions contained in Schedule 2 and to such other conditions as the local government considers appropriate.
- (2) In respect of a particular application for a licence, the local government may vary any of the conditions contained in Schedule 2.
- (3) Operators of a Cat Management Facility must comply with their obligations as specified in Division 3 of Part 3 of the Act.

4.6 Compliance with conditions of approval

A licensee who does not comply with the conditions of a licence commits an offence.

4.7 Fees

- (1) On lodging an application for a licence, the applicant is to pay a fee to the local government.
- (2) On renewal of a licence, the licensee is to pay a fee to the local government.
- (3) On lodging an application for the transfer of a valid licence, the transferee is to pay a fee to the local government.
- (4) The fees referred to in subclause (1) to (3) are to be imposed and determined by the local government under sections 6.16 to 6.19 of the *Local Government Act 1995*.

4.8 Exemption from requirement to pay fees

- (1) In this clause–

charitable organisation means–

- (a) An institution, association, club, society or body whether incorporated or not–
 - (i) Where its objectives are charitable, benevolent, educational, or other like nature concerned with the welfare of cats; and
 - (ii) From which any members does not receive any pecuniary profit.

- (2) the local government may waive any fee required to be paid by the applicant for a licence, or the fee for the renewal of a licence by a charitable organisation.

4.9 Form of licence

The licence is to be in the form determined by the local government and is to be issued to the licensee.

4.10 Period of licence

- (1) The period of effect of a licence is 12 months from the date of issue.
- (2) A licence is to be renewed if the fee referred to in clause 4.7(2) is paid to the local government prior to the expiry of the licence.
- (3) On the renewal of a licence the conditions of the licence at the time of its renewal continue to have effect.

4.11 Variation or cancellation of licence

- (1) The local government may vary the conditions of a licence and that variation will come into effect seven (7) days after the notice date.
- (2) The local government may cancel a licence –
 - (a) on the request of the licensee;
 - (b) following a breach of the Act, the Regulations or this local law; or
 - (c) if, in the local government's opinion, the licensee is not a fit and proper person to hold a licence.
- (3) The date a licence is cancelled is to be, in the case of –
 - (a) paragraph (a) of subclause (2), the date requested by the licensee; or
 - (b) paragraphs (b) and (c) of subclause (2), the date determined by an Authorised Person.
- (4) If a licence is cancelled the fee paid for that licence is not refundable for the term of the licence that has not yet expired.

4.12 Transfer

- (1) An application for the transfer of a valid licence from the licensee to another person must be –
 - (a) made in the form determined by the local government;
 - (b) made by the transferee;
 - (c) made with the written consent of the licensee; and
 - (d) lodged with the local government together with –
 - (i) written evidence that a person to whom the licence is proposed to be transferred will reside at or within reasonably close to the proximity to the premises subject to the licence; and
 - (ii) the fee for the application for the transfer of a licence referred to in clause 4.7(3).
- (2) The local government is not to determine an application for the transfer of a valid licence until the transferee has complied with subclause (1).
- (3) The local government may approve, whether or not subject to such conditions as it considers appropriate, or refuse to approve an application for the transfer of a valid licence.
- (4) Where the local government approves an application for the transfer of a valid licence, then on the date of the approval, unless otherwise specified in the notice issued under subclause 4.13(b), the transferee becomes the licensee of the licence for the purposes of this local law.

4.13 Notification

The local government is to give written notice to –

- (a) an applicant for a licence of the local government's decision on her or his application;
- (b) a transferee of the local government's decision on her or his application for the transfer of a valid licence;
- (c) a licensee of any variation made under clause 4.11(1);
- (d) a licensee when her or his licence is due for renewal and the manner in which it may be renewed;
- (e) a licensee when her or his licence is renewed;
- (f) a licensee of the cancellation of a licence under clause 4.11(2)(a); and
- (g) a licensee of the cancellation of a licence under paragraphs (b) or (c) of clause 4.11(2).

4.14 Inspection of Cat Management Facility

Subject to the provisions of the power to enter premises within the Act, an authorised person may inspect an approved Cat Management Facility.

4.15 Record Keeping

All designated Cat Management Facilities are required to keep and maintain a register of all cats entering and leaving the facility, and where entry to the premises has been made under clause 4.14, an Authorised Person may inspect the register.

PART 5 – MISCELLANEOUS

Division 1 – General

5.1 Pound

The local government may establish and maintain a pound or pounds for the impounding of a cat seized pursuant to the provisions of the Act or this local law.

5.2 Pound Fees

The fees and charges in relation to the seizure, impounding and maintenance of a cat and the maintenance thereof in a pound payable under the Act, are those approved by the local government from time to time.

5.3 Fees and Charges

All fees and charges applicable under this local law must be as determined by the local government from time to time in accordance with sections 6.16 to 6.19 of the Act.

5.4 False or Misleading Statement

A person must not make a false or misleading statement in connection with any application, requirement or demand under this local law.

5.5 Serving of Infringement Notices

An infringement notice served under section 62 of the Act or this local law may be given to a person –

- (a) personally;
- (b) by registered mail addressed to the person; or
- (c) by leaving it for the person at his or her address.

5.6 Offence to fail to comply with notice

Whenever the local government gives a notice under this local law requiring a person to do anything, if a person fails to comply with the notice, that person commits an offence.

5.7 Local government may undertake requirements of notice

- (1) Where a person fails to comply with a notice referred to in clause 5.5, the local government may do the thing specified in the notice and recover from the person to whom the notice was given, as a debt, the costs incurred in so doing.
- (2) Notwithstanding subclause (1) any entry into private property is subject to the Act.

Division 2 - Right of Appeal and Review

5.8 Appeal and review rights

When the local government makes a decision as to whether it will—

- (a) grant a person a permit, or licence under this local law; or
- (b) renew, vary, transfer or cancel a permit or licence that a person has under this local law, the provisions of *Division 1 of Part 9 of the Act* and *regulations 33 of the Local Government (Functions and General) Regulations 1996* apply to that decision; or
- (c) give a person a notice.

The provisions of *Division 1 of Part 9 of the Act* and *regulation 33 of the Local Government (Functions and General) Regulations 1996* apply to that decision.

PART 6 - ENFORCEMENT

6.1 Offences and Penalties

- (1) Any person who fails to do anything required or directed to be done under this local law, or who does anything which under this local law that person is prohibited from doing, commits an offence.
- (2) Any person who commits an offence under this local law is to be liable, upon conviction, to a penalty not less than \$1000 and not exceeding \$5,000, and if the offence is of a continuing nature, to an additional penalty not exceeding \$500 for each day or part of a day during which the offence has continued.

6.2 Modified Penalties and Offence Description

- (1) An offence against any provision of this local law is a prescribed offence for the purposes of section 62 of the Act.
- (2) The amount of the modified penalty for a prescribed offence is the amount specified in the fourth column of Schedule 4.

6.3 Form of notices

For the purposes of this local law –

- (a) the form of the infringement notice referred to in section 9.13 of the Act is to be in the form of Form 1 of Schedule 1 of the *Local Government (Functions and General) Regulations 1996*;
- (b) the form of the notice referred to in section 9.17 of the Act is to be in the form of Form 2 in Schedule 1 of the *Local Government (Functions and General) Regulations 1996*;
- (c) the form of the infringement withdrawal notice referred to in section 9.20 of the Act is to be in the form of Form 3 in Schedule 1 of the *Local Government (Functions and General) Regulations 1996*;
- (d) the issue of infringement notices, their withdrawal and the payment of modified penalties are dealt with in Division 4 of Part 4 of the Act;
- (e) an infringement notice given under the Act is to be in the form of Form 6 of Schedule 1 of the Regulations; and
- (f) a notice sent under the Act withdrawing an infringement notice is to be in the form of Form 7 of Schedule 1 of the Regulations.

**SCHEDULE 1 – APPLICATION FOR A LICENCE FOR A DESIGNATED CAT
MANAGEMENT FACILITY**

[clause 4.2]

APPLICANT/S DETAILS

Name of Applicant/s (in full).....
Residential Address.....
.....(Suburb) Post Code.....

Postal Address (if different from above)

Telephone
(Home).....(Work).....(Mobile).....

Email.....
Fax.....

CAT MANAGEMENT FACILITY DETAILS

I/ We apply for a licence for a designated cat management facility at:
Address of premises

.....Suburb Post Code

For number of cats

Person will reside (tick appropriate box) *evidence to be provided

- At the premises
- Sufficiently close to the premises so as to control the cats and so as to ensure their health and welfare

Name of person (if not applicant/s)
Address of residence (if not residing at the premises)

Prior to approval the following must be attached:

- (a) A site plan of the premises showing the location of the cages and runs and all other building and structures and fences;
- (b) Plans and specifications of the Cat Management Facility;
- (c) Proposed details of how the facility will be kept secure;
- (d) Evidence that a person will reside–
 - i. at the premises; or
 - ii. sufficiently close to the premises so as to control the cats and so as to ensure their health and welfare; and
 - iii. if the person in item (d) is not the applicant, evidence that the person is a person in charge of the cats.

Signature of applicant.....

Date.....

Note:

A licence, if issued, will have effect for a period of 12 months, effective from the date of issue unless and until it is revoked or it is determined by the local government non-compliance with the conditions of the *Shire of Northam Cat Local Law 2019* justifies this.

APPLICATION FEE Cat Management Facility Establishment Fee \$200.00

OFFICE USE ONLY

Application No..... Date...../...../.....

Receipt No.

Amount Paid

Cashier

SCHEDULE 2 – MINIMUM CONDITIONS OF A DESIGNATED CAT MANAGEMENT FACILITY

[clause 4.5(1)]

An application for a licence within the District may be approved subject to the following conditions –

1 Cat Management Facility Building, Fixtures, Equipment and Appliances:

- 1.1 All building enclosures must be structurally sound, have impervious flooring, be well lit and ventilated and otherwise comply with all legislative requirements.
- 1.2 The Cat Management Facility must have a feed room, wash area, isolation cages and maternity section.
- 1.3 Materials used in structures are to be approved by the local government. The internal surfaces of walls are, where possible, to be smooth, free from cracks, crevices and other defects.
- 1.4 All fixtures, fittings and appliances are to be capable of being easily cleaned, resistant to corrosion and constructed to prevent the harbourage of vermin.
- 1.5 A wash hand basin with the minimum of piped cold water is to be provided in the building.
- 1.6 A Cat Management Facility must have a secure area where cats are housed and can exercise and must be at a distance of not less than 10 metres from the front boundary of the premises and 5 metres from any other boundary of the premises;
- 1.7 A Cat Management Facility must have adequate measures in place to minimise the risk of unauthorised entry into the facility;
- 1.8 Where floor washing is required, washings must pass through the drains and must be piped to an approved apparatus for the treatment of sewage (as specified by the *Health (Treatment of Sewage and Disposal of Effluent and Liquid Waste) Regulations 1974*) and in accordance with the health requirements of the local government;
- 1.9 All external surfaces of each Cat Management Facility must be impervious and kept in good condition;
- 1.10 A Cat Management Facility must have sufficient ventilation to keep animal housing areas free of dampness, noxious odours and draughts, and prevent accumulation or concentrations of gases;
- 1.11 A Cat Management Facility should supply fresh air, or if the animals are housed in a totally enclosed area where forced ventilation is the only form of air movement, there should be adequate air exchange rate;
- 1.12 The Cat Management Facility is to be located away from sources of excessive noise or pollution, and draughts that could cause injury or stress to animals;
- 1.13 Natural lighting or lighting that duplicates the characteristics of natural light including a simulated day/ night period;
- 1.14 All cages and outdoor enclosures are to have adequate shelter in the form of a roof constructed of impervious material;
- 1.15 Must have a mix of cages to provide for individual housing where required and cages or modules constructed of impervious, washable materials;
- 1.16 All cages, outdoor enclosures and drinking vessels must be maintained in a clean condition and must be cleaned and disinfected. If in the opinion of an Authorised Person, the cage or vessel requires cleaning, an order may be given by the Authorised Person.

2. Cat Management Facility Operations and Maintenance:

- 2.1 Enclosures are to be thoroughly cleaned each day and disinfected at least once a week to minimise disease.
 - 2.2 All refuse, faeces and food waste must be disposed of daily to the satisfaction of an Authorised Person.
 - 2.3 Noise, odours, vermin, fleas, flies and other vectors of disease must be effectively controlled.
 - 2.4 Suitable water both for cleaning and drinking must be available at the Cat Management Facility.
 - 2.5 The maximum number of cats to be kept on the premises stated on the licence is not to be exceeded.
 - 2.6 An entry book is to be kept recording in respect of each cat the—
 - (i) date of admission;
 - (ii) date of departure;
 - (iii) breed, age, colour and sex; and
 - (iv) the name and residential address of the keeper.
 - 2.7 The entry book is to be made available for inspection on the request of an Authorised Person; and
 - 2.8 The licensee or the person nominated in the application for a licence, must, in accordance with the application for the licence, continue to reside –
 - (a) At the premises; or
 - (b) In the opinion of the local government, sufficiently close to the premises so as to control the cats, and to ensure their health and welfare.
- 3. Cat Management Facility Additional conditions:**
- 3.1 Any other matter which in the opinion of the local government is deemed necessary for the health and well-being of any cat, or person, or adjoining premises or the amenity of the area (or any part thereof).

SCHEDULE 3 - OFFENCES AND MODIFIED PENALTIES

[Clause 6.2]

Item No.	Clause No.	Nature of offence	Modified Penalty \$
1.	23(1)(a)	Keeping more than 2 cats over the age of 6 months on a premises without an approval	200
2.	23(1)(b)	Using a premises as a cattery without an approval	200
3.	2.6	Failing to comply with conditions of an application for additional cats	200
4.	3.1	Failing to take all reasonable measures to prevent a cat creating a nuisance	200
5.	3.2(2)	If a cat is at any time in a place in contravention of clause 3.2(1)	200
	3.2(3)(a) (b)	A cat shall not be in a place that is not a public place unless – (a) consent to its being there has been given by the occupier, or a person apparently authorised to consent on behalf of the occupier; and	200
	3.2(4)	If a cat is at any time in a place in contravention of any of the Shire of Northam Cat Local law 2019-	200
6.	3.3(a)	Failing to keep premises free of excrement, filth, food waste and other matter likely to be offensive or injurious to health or attract vermin.	200
7.	3.3(b)	Failing to clean and disinfect premises when directed by an Authorised Person	200
8.	3.3(c)	Failing to keep premises free of flies or when directed by an Authorised Person spray premises with residual insecticide or other means to kill or repel flies	200
9.	4.1	Operating a Cat Management Facility without a licence	500
10.	4.6	Failing to comply with conditions imposed by the local government	200
11.	5.5	Failing to comply with a notice issued under this local law	500
12.	6.1	All other offences not specified	200

Dated this.....day of2019

The Common Seal of the)
Shire of Northam was)
affixed by authority of a)
resolution of the Council)
in the presence of)

.....
CHRISTOPHER ANTONIO
President

.....
JASON WHITEAKER
Chief Executive Officer

Attachment 2

LOCAL GOVERNMENT ACT 1995

SHIRE OF NORTHAM

FENCING LOCAL LAW 2019

LOCAL GOVERNMENT ACT 1995

SHIRE OF NORTHAM

FENCING LOCAL LAW 2019

CONTENTS

PART 1 – PRELIMINARY

- 1.1 Title
- 1.2 Commencement
- 1.3 Repeal
- 1.4 Application
- 1.5 Interpretation
- 1.6 Relationship with other laws
- 1.7 Permit fees and charges

PART 2 – SUFFICIENT FENCES

- 2.1 Sufficient fences

PART 3 – GENERAL

- 3.1 Fences within front setback areas
- 3.2 Maximum height of fences
- 3.3 Fences on a rural lot
- 3.4 Maintenance of fences
- 3.5 Fences in relation to fill
- 3.6 Gates in fences
- 3.7 Fences across rights-of-way, public access ways or thoroughfares
- 3.8 General discretion of the Local Government
- 3.9 Estate Fences
- 3.10 Tennis Court Fences

PART 4 – FENCING MATERIALS

- 4.1 Fencing materials
- 4.2 Pre-used fencing materials
- 4.3 Barbed wire and broken glass fences
- 4.4 Fences Screening and Colours

PART 5 – ELECTRIFIED AND RAZOR WIRE FENCES

- 5.1 Requirements for a permit
- 5.2 Application for a permit
- 5.3 Determining an application
- 5.4 Transfer of a permit
- 5.5 Cancellation of a permit
- 5.6 Right of appeal and review

PART 6 – NOTICES OF BREACH

- 6.1 Notices of breach

PART 7 ENFORCEMENT

- 7.1 Offences and penalties
- 7.2 Modified penalties
- 7.3 Form of notices

**First Schedule
Specifications for a Sufficient Fence on a Residential Lot**

**Second Schedule
Permit for an Electrified Fence**

**Third Schedule
Permit for a Razor Wire Fence**

**Fourth Schedule
Offences and Modified Penalties**

LOCAL GOVERNMENT ACT 1995

SHIRE OF NORTHAM

FENCING LOCAL LAW 2019

Under the powers conferred by the *Local Government Act 1995* and by all other powers enabling it, the Council of the Shire of Northam resolved on2019 to make the following local law.

PART 1 - PRELIMINARY

1.1 Title

This local law may be cited as the *Shire of Northam Fencing Local Law 2019*.

1.2 Commencement

This local law comes into operation on the 14th day after the day on which it is published in the *Government Gazette*.

1.3 Repeal

The *Shire of Northam Fencing Local Law 2008* published in the *Government Gazette* on 16 September 2008 and all amendments thereto are hereby repealed on the day this local law comes into operation.

1.4 Application

This local law applies throughout the district.

1.5 Interpretation

(1) In this local law, unless the context requires otherwise—

Act means the *Local Government Act 1995*;

AS/NZS means an Australian Standard published by the Standards Association of Australia and as amended from time to time;

Authorised Person means a person authorised by the local government under section 9.10 of the *Local Government Act 1995* to carry out functions with respect to this local law;

boundary fence means a fence, other than a dividing fence, that separates the lands of different owners whether the fence is on the common boundary of adjoining lands or on a line other than a common boundary;

building permit means a building permit issued pursuant to the *Building Act 2011*;

CEO means the Chief Executive Officer of the Shire of Northam;

commercial lot means a lot where a commercial use—

- (a) is or may be permitted under the town planning scheme; and
- (b) is or will be the predominant use of the lot;

dangerous in relation to any fence means –

- (a) an electrified fence other than a fence in respect of which a permit under Part 5 of this local law has been issued and is current;
- (b) a fence containing barbed wire other than a fence erected and maintained in accordance with this local law;
- (c) a fence containing exposed broken glass, asbestos fibre, razor wire or any other potentially harmful projection or material; or
- (d) a fence which is likely to collapse or fall, or part of which is likely to collapse or fall, from any cause.

district means the district of the local government;

dividing fence means a fence that separates the lands of different owners whether the fence is on the common boundary of adjoining lands or on a line other than the common boundary;

electrified fence means a fence carrying or designed to carry an electric charge;

electrified fence permit means a permit, in the form of the Second Schedule, to have and use an electrified fence on the lot to which the permit applies;

estate boundary fence means a fence around the external boundary of a subdivision to indicate the extent of that subdivision and includes any special works or construction that indicates the entrance to that land;

estate entry statement means a fence or wall that identifies the entrance of an estate, and includes any sign (indicating the estate name and locality) sculpture, flagpole or flag;

estate fence means an estate entry statement or an estate boundary fence;

fence means any structure, that is used or functioning as a barrier, irrespective of where it is located and includes a gate that separates the road reserve and a lot adjacent to the road reserve;

front boundary means the boundary that separates a thoroughfare and the front of the lot;

front setback means the horizontal distance between the front boundary and a wall of the building measured at right angle to the front boundary;

height in relation to a fence means the vertical distance between–

- (a) the top of the fence at any point; and
- (b) the ground level or, where the ground levels on each side of the fence are not the same, the higher ground level, immediately below that point;

industrial lot means a lot where an industrial use–

- (a) is or may be permitted under the town planning scheme; and
- (b) is or will be the predominant use of the lot;

land includes a house, building, work, or structure, in or on the land;

local government means the Shire of Northam;

lot means a defined portion of land for which a separate certificate of title has been issued and includes a strata lot;

natural ground level, in relation to a development, means –

- (a) the level approved, for the purposes of the development, by the local government, under a local planning scheme; or
- (b) in any other case, the level which existed immediately before the commencement of the development, (including any site works);

non-sacrificial graffiti protection means a coating applied to a fence or wall which is not removed in the process of removing graffiti;

notice of breach means a notice referred to in clause 6.1(1);

occupier has the meaning given to it in the *Local Government Act 1995*;

owner for the purposes of the definition of 'dividing fence', has the meaning given to it in the Act;

owner for all other purposes, has the meaning given to it in the *Local Government Act 1995*;

permit means an electrified fence permit or a razor wire fence permit under Part 5;

person has the meaning given to it in the *Interpretation Act 1984*;

public place means a place to which the public has access;

reserve means land (including parkland or foreshore) in or adjoining the district that is –

- (a) set apart for the use and enjoyment of the public; or
- (b) Acquired for public purposes and vested in or under the care control and management of the local government;

razor wire fence permit means a permit, in the form of the Third Schedule, to construct a fence wholly or partly of razor wire on the lot to which the permit applies;

residential lot means a lot where a residential use–

- (a) is or may be permitted under a local planning scheme; and
- (b) is or will be the predominant use of the lot;

retaining wall means any structure which prevents the movement of soil in order to allow ground levels of different elevations to exist adjacent to one another;

right of way means a portion of land that is—

- (a) shown and marked 'Right of Way' or 'R.O.W', or coloured or marked in any other way to signify that the portion of land is a right of way, on any plan or diagram deposited with the Registrar of Titles that is subject to the provisions of section 167A of the *Transfer of Land Act 1893*;
- (b) shown on a diagram or plan of survey relating to a subdivision that is created as a right of way and vested in the Crown under section 152 of the *Planning and*

- Development Act 2005*; or
- (c) shown and marked as a right of way on a map or plan deposited with the Registrar of Titles and transferred to the Crown under the *Transfer of Land Act 1893*, but does not include—
- (i) private driveway; or
 - (ii) right of way created by easement between two parties;

rural lot means a lot where a rural use —

- (a) is or may be permitted under a local planning scheme; and
- (b) is or will be the predominant use of the lot;

rural residential lot means a lot where a rural residential use —

- (a) is or may be permitted under the local planning scheme; or
- (b) is or will be the predominant use of the lot; and
- (c) is generally ranging from 1 to 4 hectares.

rural smallholdings lot means a lot where a rural smallholdings use —

- (a) is or may be permitted under the local planning scheme; or
- (b) is or will be the predominant use of the lot; and
- (c) is generally ranging in size from 4 to 40 hectares.

schedule means a schedule to this local law;

setback area has the meaning given to it for the purposes of a local planning scheme;

sufficient fence means a fence described in clause 2.1; and includes a fence of the description and quality agreed upon by the owners of adjoining lots which does not fail to satisfy clause 2.1

thoroughfare has the meaning given to it in the *Local Government Act 1995*;

planning scheme means a local planning scheme of the local government made under the *Planning and Development Act 2005*;

unsightly has the meaning given to it in and for the purposes of the *Local Government Act 1995*;

written law has the same meaning given to it by section 5 of the *Interpretation Act 1984* and includes this local law.

- (2) Any other expression used in this local law and not defined herein must have the meaning given to it in the—
- (a) *Local Government Act 1995*;
 - (b) *Dividing fences Act 1961*
 - (c) *Building Act 2011*; or
 - (d) *Planning and Development Act 2005*;
- unless the context requires otherwise.
- (3) A reference to an Australian Standard is to that Australian Standard as it is amended from time to time.

1.6 Relationship with other laws

- (1) In the event of any inconsistency between the provisions of a local planning scheme and the provisions of this local law, the provisions of the local planning scheme are to prevail.
- (2) Nothing in this local law affects a provision in any other written law in respect of a building permit for a fence.

1.7 Permit fees and charges

All permit fees and charges applicable under this local law shall be as determined by the local government from time to time in accordance with section 6.16 to 6.19 of the *Local Government Act 1995*.

PART 2 - SUFFICIENT FENCES

2.1 Sufficient fences

- (1) A person shall not erect a dividing fence or a boundary fence that is not a sufficient fence.
- (2) Subject to subclauses (3) and (4), a sufficient fence—
 - (a) on a residential lot is a dividing fence or a boundary fence constructed and maintained in accordance with the specifications and requirements of the First Schedule.
 - (b) on a commercial lot and on an industrial lot is a dividing fence or a boundary fence constructed and maintained in accordance with the specifications and requirements of the First Schedule;
 - (c) on a rural lot, rural residential lot or rural small holding lot is a dividing fence or a boundary fence constructed and maintained in accordance with the specifications and requirements of the First Schedule;
- (3) Where a fence is erected on or near the boundary between—
 - (a) a residential lot and an industrial lot, a sufficient fence is a dividing fence constructed and maintained in accordance with the specifications and requirements of the First Schedule;
 - (b) a residential lot and a commercial lot, a sufficient fence is a dividing fence constructed and maintained in accordance with the specifications and requirements of the First Schedule;
 - (c) a residential lot and a rural lot, rural residential or rural small holding a sufficient fence is a dividing fence constructed and maintained in accordance with the specifications and requirements of the First Schedule;
- (4) Unless the local government specifies otherwise, a sufficient fence on a boundary between lots other than those specified in subclause (3) is a dividing fence constructed in accordance with the specifications and requirements of the First Schedule.
- (5) Notwithstanding any other provisions in this local law, a fence constructed of stone or concrete shall be a sufficient fence only if it is designed by a structural engineer where—
 - (a) it is greater than 1800mm in height; or
 - (b) the local government so requires.

PART 3 - GENERAL

3.1 Fences within front setback areas

- (1) A person shall not, without the written consent of the local government, erect a free-standing fence greater than 1200mm in height, within the front set-back area of a residential lot within the district.
- (2) The local government may approve the erection of a fence of a height greater than 1200mm in the front setback area of a residential lot only if the fence on each side of the driveway into the Lot across the front boundary is to be angled into the Lot for a instance of not less than 1500mm along the frontage to a distance of not less than 1500mm from the frontage in order to provide appropriate splayed lines of vision for a motorist using the driveway for access to a thoroughfare.
- (3) The provision of subclause (2) shall not apply to a fence—
 - (a) of open construction that does not obscure the lines of vision of a motorist using the driveway for access to a thoroughfare; or
 - (b) that does not adjoin a footpath.
- (4) Secondary street fences shall be visibly permeable above 1200mm from natural ground level for 50% of the length of the street boundary, right of way or access leg and shall allow surveillance from an outdoor living area and/or major opening such as a window to a habitable room.

3.2 Maximum height of fences

A person shall not erect a fence that is greater in height than—

- (a) 1800mm on a residential or rural lot, or
- (b) 2400mm on a commercial or industrial lot.

3.3 Fences on a rural lot

A person shall not without the written consent of the local government, erect a fence on a rural lot, within 7.5m of a thoroughfare of a height exceeding 1500mm.

3.4 Maintenance of fences

- (1) An owner or occupier of a lot on which a fence is erected shall maintain the fence in good condition and so as to prevent it from becoming dangerous, dilapidated, unsightly or prejudicial to the amenity of the locality.

- (2) Where in the opinion of an Authorised Person, a fence is in a state of disrepair or is dangerous or is otherwise in breach of a provision of this local law, an Authorised Person may give notice in writing to the owner or occupier (as the case requires) of the land on which the fence is erected, requiring the owner or occupier to modify, repair, paint, or maintain the fence within the time and in the manner specified in the notice.
- (3) A notice issued pursuant to subclause (2) may contain a condition requiring that the fence be treated with a non-sacrificial graffiti protection treatment, which protection treatment must be applied in accordance with the manufacturer's specifications.

3.5 Fences in relation to fill

- (1) A free standing fence constructed of corrugated fibre reinforced pressed cement must not have more than 150mm difference in soil levels on each side.
- (2) Where land has been filled or retained to a height of more than 500mm above natural ground level at or within 1m of a boundary, a person must only erect a dividing fence that is a sufficient fence on the said fill or retaining wall if the applicant produces to the local government written agreement from all and any adjoining land owners.

3.6 Gates in fences

A person shall not erect a fence which does not—

- (a) open into a lot, if the gate is providing access to a thoroughfare; or
- (b) open by sliding parallel and on the inside of the fence, which it forms part of, when closed.

3.7 Fences across rights-of-way, public access ways or thoroughfares

A person shall not, without the approval of the local government, erect or maintain a fence or obstruction of a temporary or permanent nature across any rights-of-way, public access way or thoroughfare so as to impede or prevent use of those facilities in the manner for which they are intended and constructed.

3.8 General discretion of the local government

- (1) Notwithstanding clauses 2.1 and 3.2, the local government may consent to the erection or repair of a fence which does not comply with the requirements of this local law.
- (2) In determining whether to grant its consent to the erection or repair of any fence, the local government may consider, in addition to any other matter that it is authorised to consider, whether the erection or retention of the fence would have an adverse effect on—
 - (a) the safe or convenient use of any land;
 - (b) the safety or convenience of any person; or
 - (c) the visual amenity of the locality.

3.9 Estate Fences

- (1) A person must not construct an estate fence without a permit.
- (2) Where an estate fence is constructed and contains an estate name, the estate fence must also depict the suburb name in equal prominence.
- (3) An owner or occupier of a lot adjacent to an estate boundary must, where that estate boundary fence is damaged, dilapidated or in need of repair, ensure that—
 - (a) It is repaired or replaced with the same or similar materials with which it was first constructed; and
 - (b) so far as is practicable the repaired or replaced section is the same as the original fence.

3.10 Tennis Court Fences

- (1) This clause does not apply to a rural lot.
- (2) A person shall not erect a fence around or partly around a tennis court on a lot unless –
 - (a) The fence is less than 3.6m in height.
 - (b) The whole of the fence is at least 900mm from the boundary between the lot on which the tennis court is located and the adjoining lot or if it is less than 900mm, the owner of the adjoining lot has been given the opportunity to make submissions to the local government on the location of the fence; and
 - (c) The fence is constructed of chain link fabric mesh and is 50mm x 2.5mm poly vinyl chloride coated or galvanised, and is erected in accordance with the manufacturers specifications

PART 4 - FENCING MATERIALS

4.1 Fencing materials

- (1) A person shall construct any fence on a residential lot, rural residential lot, small holding lot, commercial lot or an industrial lot from only those materials specified for a sufficient fence in respect of such lot in the First Schedule or some other material approved by the local government.
- (2) No person shall erect a fence of impervious material in any place, position or location where it will, or is likely to, act as a barrier to or restrict the flow of stormwater or a watercourse.

4.2 Pre-used fencing materials

- (1) A person must not construct a dividing fence on a residential lot, rural residential lot, small holding lot, commercial lot or an industrial lot from pre-used materials without the written consent of the local government or an Authorised Person.

- (2) Where the local government or an Authorised Person approves, under this Part, the use of pre-used materials in the construction of a fence that approval must be conditional on the applicant painting or treating the pre-used material as directed by the local government or an Authorised Person.

4.3 Barbed wire and broken glass fences

- (1) This clause does not apply to a fence constructed wholly or partly of razor wire.
- (2) An owner or occupier of a residential lot or a commercial lot shall not erect or affix to any fence on such a lot any barbed wire or other material with spiked or jagged projections, unless the prior written approval of the local government has been obtained.
- (3) An owner or occupier of an industrial lot shall not erect or affix on any fence bounding that lot any barbed wire or other materials with spiked or jagged projections unless the wire or materials are not nearer than 2000mm from the ground level.
- (4) If the posts which carry the barbed wire or other materials referred to in subclause (3) are angled towards the outside of the lot bounded by the fence the face of the fence must be set back from the lot boundary a sufficient distance to ensure that the angled posts, barbed wire or other materials do not encroach on adjoining land.
- (5) An owner or occupier of a lot shall not affix or allow to remain as part of any fence or wall, whether internal or external, on that lot any broken glass.
- (6) An owner or occupier of a rural lot shall not place or affix barbed wire upon a fence on that lot where the fence is adjacent to a thoroughfare or other public place unless the barbed wire is fixed to the side of the fence posts furthest from the thoroughfare or other public place.

4.4 Fence Screening and Colours

- (1) On a residential lot, commercial lot, or industrial lot, any screening affixed to a fence shall be designed to integrate with the colours, materials and specification of that sufficient fence, to the satisfaction of the local government.
- (2) On a rural residential lot, rural smallholdings lot or rural lot, no person shall affix any screening to a fence.
- (3) Screening affixed to a fence shall be installed and maintained in accordance with the manufacturers specifications and shall not undermine the structural integrity of the fence.

PART 5 - ELECTRIFIED AND RAZOR WIRE FENCES

5.1 Requirements for a Permit

- (1) An owner or occupier of a lot, other than a rural lot, shall not—
 - (a) have and use an electrified fence on that lot without first obtaining a permit under subclause (2); or
 - (b) construct a fence wholly or partly of razor wire on that lot without first obtaining a permit under subclause (3).
- (2) A permit to have and use an electrified fence shall not be issued—
 - (a) in respect of a lot which is or which abuts a residential lot;
 - (b) unless the fence is of a design which will comply with AS/NZS 3016:2002 Electrical installations – Electricity security fences; and
 - (c) unless provision is made so as to enable the fence to be rendered inoperable during the hours of business operations, if any, on the lot where it is erected.
- (3) A permit to have a fence constructed wholly or partly of razor wire shall not be issued—
 - (a) if the fence is within 3m of the boundary of the lot;
 - (b) where any razor wire used in the construction of the fence is less than 2000mm or more than 2400mm above the ground level.
- (4) An application for a permit referred to in subclauses (2) or (3) shall be made by the owner of the lot on which the fence is or is to be erected, or by the occupier of the lot with the written consent of the owner.

5.2 Application for a Permit

- (1) An owner or occupier of land may apply to the local government for an electrified fence permit or a razor wire fence licence permit.
- (2) An application for a permit must—
 - (a) be in the form determined by the local government;
 - (b) include:
 - (i) a written consent signed by the owner of the land on which the proposed fence is to be located – unless the applicant is the owner of that land; and
 - (ii) any further information may be required by the local government; and
 - (c) be accompanied by any fee imposed by the Council under sections 6.16 to 6.19 of the *Local Government Act 1995*.

5.3 Determining an application

- (1) The local government may refuse to consider an application that does not comply with clause 5.2.
- (2) The local government may—
 - (a) approve an application, subject to any conditions that it considers to be appropriate; or
 - (b) refuse to approve an application.
- (3) If the local government approves an application, it is to issue a permit in the form set out in the Second Schedule or the Third Schedule (as the case may be).
- (4) The local government may vary a condition to which a permit is subject by giving written notice to the permit holder and the varied condition takes effect 7 days after that notice is given.

5.4 Transfer of a permit

- (1) A permit referred to in clause 5.1 shall transfer with the land to any new occupier or owner of the lot, to which the permit applies.
- (2) On an application by a new owner or occupier, the local government is to transfer the relevant permit to that new owner or occupier (as the case may be) by a written endorsement on the permit.

5.5 Cancellation of a Permit

Subject to Division 1 Part 9 of the *Local Government Act 1995*, the local government may cancel a permit issued under this Part if—

- (a) the permit holder requests the local government to do so;
- (b) the fence to which the permit applies is being demolished and not being rebuilt for at least 6 months;
- (c) the fence no longer satisfies the requirements specified in clause 5.1(2) or 5.1(3) as the case may be;
- (d) the permit holder breaches any condition upon which the permit has been issued; or
- (e) the permit holder fails to comply with a notice issued under clause 6.1.

5.6 Right of appeal and review

When the local government makes a decision as to whether it will —

- (a) grant a person a permit under this local law;
- (b) renew, vary, or cancel a permit, that a person has under this local law, or
- (c) give a person a notice.

the provisions of Division 1 of Part 9 of the *Local Government Act 1995* and regulation 33 of the *Local Government (Functions and General) Regulations 1996* apply to that decision.

PART 6 - NOTICES OF BREACH

6.1 Notices of breach

- (1) Where a breach of any provision of this local law has occurred in relation to a fence on a lot, the local government may give a notice in writing to the owner of that lot ('notice of breach').
- (2) A notice of breach shall—
 - (a) specify the provision of this local law which has been breached;
 - (b) specify the particulars of the breach; and
 - (c) state that the owner or occupier of the lot is required to remedy the breach within 28 days from the giving of the notice.

PART 7 – ENFORCEMENT

7.1 Offences and penalties

- (1) A person who fails to comply with a notice of breach commits an offence and is liable upon conviction to a penalty of not less than \$500 and not exceeding \$5000 and, if the offence is a continuing offence, to a maximum daily penalty of \$500.
- (2) A person who fails to comply with or who contravenes any provision of this local law commits an offence and is liable to maximum penalty of \$5000 and, if the offence is a continuing offence, to a maximum daily penalty of \$500.

7.2 Modified penalties

- (1) An offence against any provision of this local law is a prescribed offence for the purposes of section 9.16 of the *Local Government Act 1995*.
- (2) The amount of the modified penalty for a prescribed offence is that specified adjacent to the clause in the Fourth Schedule.
- (3) Before giving an infringement notice to a person in respect of the commission of a prescribed offence, an Authorised Person should be satisfied that—
 - (a) commission of the prescribed offence is a relatively minor matter; and
 - (b) only straightforward issues of law and fact are involved in determining whether the prescribed offence was committed, and the facts in issue are readily ascertainable.

7.3 Form of notices

For the purposes of this local law–

- (a) the form of the infringement notice referred to in section 9.17 of the *Local Government Act 1995* is to be in the form of Form 2 of Schedule 1 of the *Local Government (Functions and Genera.) Regulations 1996*; and
- (b) the form of the withdrawal of infringement notice referred to in section 9.20 of the *Local Government Act 1995* is to be in the form of Form 3 in Schedule 1 of the *Local Government (Functions and Genera.) Regulations 1996*.

FIRST SCHEDULE

SPECIFICATIONS FOR A SUFFICIENT FENCE

[clause 2.1]

Each of the following is a "sufficient fence" on the specified lot type:

A. RESIDENTIAL LOT

(1) Timber fence

- (a) corner posts to be 125mm x 125mm x 2,400mm and intermediate posts to be 125mm x 75mm x 2,400mm spaced at 2,400mm centres;
- (b) corner posts to be strutted two ways with 100mm x 50mm x 450mm sole plates and 75mm x 50mm struts;
- (c) intermediate posts to be doubled yankee strutted with 150mm x 25mm x 450mm struts;
- (d) all posts to have tops with a 60mm weather cut and to be sunk at least 600mm into the ground;
- (e) rails to be 75mm x 50mm with each rail spanning 2 bays of fencing double railed or bolted to each post with joints staggered;
- (f) the fence to be covered with 75mm x 20mm sawn pickets, 1,800mm in height placed 75mm apart and affixed securely to each rail;
- (g) the height of the fence to be 1,800mm except with respect to the front set back area for which there is no minimum height but which is subject to clause 2.1(2).

(2) Corrugated fence

A fence constructed of corrugated fibre reinforced pressed cement or steel sheeting constructed to manufacturer's specifications or which satisfies the following specifications –

- (a) a minimum in-ground length of 25 per cent of the total length of the sheet, but in any case with a minimum in-ground depth of 600mm;
- (b) the total height and depth of the fence to consist of a single continuous fibre reinforced cement or steel sheet;
- (c) the sheets to be lapped and capped with extruded "snap-fit" type capping in accordance with the manufacturer's written instructions;
- (d) the height of the fence to be 1.8 metres except with respect to the front set back area for which there is no minimum height but which is subject to clause 2.1(2).

(3) Brick, stone or concrete fence

A fence constructed of brick, stone or concrete, which satisfies the following requirements and specifications –

- (a) footings of minimum 225mm x 150mm concrete 15MPA or 300mm x 175mm brick laid in cement mortar or 400mm x 400mm concrete 20MPA with minimum 1 layer 4-L11TM;
- (b) pier specifications –
 - (i) continuous fence with engaged piers or infill panels between piers maximum 2.1 metres high with No. 2 R6 galvanised rod continuous in last mortar bed joint;
 - (ii) engaged or attached piers 290mm x 290mm (for 90mm wide masonry unit) and 350mm x 350mm (for 110 wide masonry unit) with No. 1 Y12 galvanised reinforcing rod tied into footing and located centrally in pier;
 - (iii) pier core to be filled with 15MPA concrete. Piers at maximum 2.1 metre centres.
- (c) expansion joints in accordance with the manufacturer's written instructions;
- (d) a minimum height of 1.8 metres up to 2.1 metres (including screening), except within the street setback area which is subject to requirements outlined in clause 3.1; and
- (e) certified by a Structural Engineer as being appropriate for the particular site and wind terrain category.

(4) Composite fence

A composite fence which satisfies the following specifications for the brick construction –

- (1) (a) brick piers of minimum 345mm x 345mm at 1,800mm centres bonded to a minimum height base wall of 514mm;
- (b) each pier shall be reinforced with one R10 galvanised starting rod 1,500mm high with a 250mm horizontal leg bedded into a 500mm x 200mm concrete footing and set 65mm above the base of the footing. The top of the footing shall be 1 course (85mm) below ground level;
- (c) the minimum ultimate strength of brickwork shall be 20MPA. Mortar shall be a mix of 1 part cement, 1 part lime and 6 parts sand;
- (d) the ground under the footings is to be compacted to 6 blows per 300mm and checked with a standard falling weight penetrometer;
- (e) control joints in brickwork shall be provided with double piers at a maximum of 6-metre centres;
- or
- (2) (a) brick piers of a minimum 345mm x 345mm x 2,700mm centres bonded to the base wall; and
- (b) each pier shall be reinforced with two R10 galvanised starting rods as previously specified.

B. RURAL RESIDENTIAL LOT, RURAL SMALLHOLDINGS LOT OR RURAL LOT

(1) Post and wire construction

In the case of a non-electrified fence of post and wire construction –

- (a) wire shall be high tensile wire and not less than 2.5mm. A minimum of 5 wires shall be used, generally with the lower wires spaced closer together than the higher wires so as to prevent smaller stock passing through, and connected to posts in all cases;
- (b) posts shall be of indigenous timber or other suitable material including –
 - (i) timber impregnated with a termite and fungicidal preservative;
 - (ii) standard iron star pickets; or
 - (iii) concrete;
- (c) if timber posts are used, posts are to be cut not less than 1,800mm long x 50mm diameter at small end if round or 125mm x 60mm if split or sawn. Posts to be placed at no more than 10 metre intervals, set minimum 600mm in the ground and 1,200mm above ground;
- (d) strainer posts, if timber, shall not be less than 2,250mm long and 150mm diameter at the small end (tubular steel to be 50mm in diameter) and shall be cut from indigenous timber or other suitable material. These shall be placed a minimum of 1,000mm in the ground and set at all corners, gateways and fence line angles but not exceeding 200 metres apart.

(2) Electrified fence

An electrified fence having 4 wires is a sufficient fence if constructed generally in accordance with a non-electrified fence.

C. COMMERCIAL LOT OR INDUSTRIAL LOT

(1) PVC coated rail-less link mesh, chain mesh or steel mesh which satisfies the following specifications –

- (a) corner posts to be minimum 50mm normal bore x 3.5mm and with footings of a 225mm diameter x 900mm;
- (b) intermediate posts to be minimum 37mm nominal bore x 3.15mm at maximum 3.5 centres and with footings of a 225mm diameter x 600mm;
- (c) struts to be minimum 30mm nominal bore x 3.15mm fitted at each gate and two at each corner post and with footings 225mm x 600mm;
- (d) cables to be affixed to the top, centre and bottom of all posts and to consist of two or more 3.15mm wires twisted together or single 4mm wire;
- (e) rail-less link, chain or steel mesh is to be to a height of 2 metres on top of which are to be 3 strands of barbed wire carrying the fence to a height of 2.4 metres in accordance with clause 4.3 of this local law; and
- (f) galvanised link mesh wire to be 2 metres in height and constructed of 50mm mesh 2.5mm galvanised iron wire and to be strained, neatly secured and laced to the posts and affixed to cables. Vehicle entry gates shall provide an opening of not less than 3.6 metres and shall be constructed of 25mm tubular framework with 1 horizontal and 1 vertical stay constructed of 20mm piping and shall be covered with 50mm x 2.5mm galvanised link mesh strained to framework. Gates shall be fixed with a drop bolt and locking attachment.

(2) Corrugated fence

A fence constructed of corrugated fibre reinforced pressed cement or steel sheeting constructed to manufacturer's specifications or which satisfies the following specifications –

- (a) a minimum in-ground length of 25 per cent of the total length of the sheet, but in any case with a minimum in-ground depth of 600mm;
- (b) the total height and depth of the fence to consist of a single continuous fibre reinforced cement or steel sheet;
- (c) the sheets to be lapped and capped with extruded "snap-fit" type capping in accordance with the manufacturer's written instructions;
- (d) the height of the fence to be 1.8 metres except with respect to the front set back area for which there is no minimum height but which is subject to clause 2.1(2).

(3) Brick, stone or concrete fence

A fence constructed of brick, stone or concrete, which satisfies the following requirements and specifications –

- (a) footings of minimum 225mm x 150mm concrete 15MPa or 300mm x 175mm brick laid in cement mortar or 400mm x 400mm concrete 20MPa with minimum 1 layer 4-L11TM;
- (b) pier specifications –
 - (i) continuous fence with engaged piers or infill panels between piers maximum 2.1 metres high with No. 2 R6 galvanised rod continuous in last mortar bed joint;
 - (ii) engaged or attached piers 290mm x 290mm (for 90mm wide masonry unit) and 350mm x 350mm (for 110 wide masonry unit) with No. 1 Y12 galvanised reinforcing rod tied into footing and located centrally in pier;
 - (iii) pier core to be filled with 15MPa concrete. Piers at maximum 2.1 metre centres.
- (c) expansion joints in accordance with the manufacturer's written instructions;
- (d) a minimum height of 1.8 metres up to 2.1 metres (including screening), except within the street setback area which is subject to requirements outlined in clause 3.1; and
- (e) certified by a Structural Engineer as being appropriate for the particular site and wind terrain category.

SECOND SCHEDULE

PERMIT FOR AN ELECTRIFIED FENCE

[clause 5.3]

This is to certify that
of
is the permit holder, subject to the conditions set out below, to have and use an electrified fence on
.....
.....
(address)

from 20 .. and until this permit is transferred or cancelled.

Dated this day of 20..

.....
Authorised Person
Shire of Northam

Conditions of Permit:

The holder of the permit must -

- (a) display the permit in a prominent position on the land or premises on which the electrified fence has been constructed;
- (b) upon the request of the local government or an Authorised Person produce to him or her this permit;
- (c) within 14 days of a change in the ownership or occupation of the land or premises in respect of which the permit has been granted, notify the local government in writing of the details of that change or those changes;
- (d) obtain the written consent of the local government prior to the commencement of any alteration, addition or other work relating to or affecting the electrified fence;
- (e) comply with AS/NZS 3016:2002; and
- (f) following construction of the fence, lodge with Western Power a certificate of installation from a qualified electrician and comply with any requirements of Western Power regarding the construction of the fence.

.....
Transfer by endorsement

This permit is transferred to
.....
of
.....
from and including the date of this endorsement.

Dated this day of 20..

.....
Authorised Person
Shire of Northam

THIRD SCHEDULE

PERMIT FOR A RAZOR WIRE FENCE

[clause 5.3]

This is to certify that
of
is the permit holder, subject to the conditions set out below, to have a fence constructed wholly or
partially of razor wire
on.....

.....
(address)

from 20 and until this permit is transferred or cancelled.

Dated this day of20 ..

.....
Authorised Person
Shire of Northam

Conditions of permit:

The holder of the permit must –

- (a) display this permit in a prominent position on the land or premises on which the fence has been constructed;
- (b) on the request of the local government or an Authorised Person, produce to him or her this permit;
- (c) within 14 days of a change in the ownership or occupation of the land or premises in respect of which the permit has been granted, notify the local government in writing of the details of that change or those changes; and
- (d) obtain the written consent of the local government prior to the commencement of any alteration, addition or other work relating to or affecting the fence.

.....
.....
Transfer by endorsement :

This permit is transferred to
of
from and including the date of this endorsement.

Dated this day of20 ..

.....
Authorised Person
Shire of Northam

FOURTH SCHEDULE - OFFENCES AND MODIFIED PENALTIES

[clause 7.2]

Item No.	Clause No.	Nature of offence	Modified Penalty \$
1.	2.1(1)	Erect a fence which is not a sufficient fence	250
2.	3.1(1)	Erect or modify a fence within the street setback area without written consent of the local government	250
3.	3.2	Erect a fence which is higher than the permitted height	250
4.	3.3	Erect a fence on a rural lot which is higher than the permitted height	250
5.	3.4(1)	Failing to maintain a fence in good condition or preventing a fence from becoming dangerous, dilapidated or unsightly	250
6.	3.5(1)	Erect or permit a fence of corrugated fibre reinforced pressed cement having soil higher than 150mm on a side of the fence	250
7.	3.6(a)	Erect a fence which contains a gate which does not open into the lot	250
8.	3.6(b)	Erect a fence which contains a sliding gate which is not located on the inside of the fence on the lot	250
9.	3.7	Erect a fence across a right of way, public access way or thoroughfare without the approval of the local government	250
10.	4.1(1)	Construct a fence on a residential lot, rural residential lot, small holding lot, commercial lot or an industrial lot from materials not approved by the local government	250
11.	4.2(1)	Construct a dividing fence on a residential lot, rural residential lot, small holding lot, commercial lot or an industrial lot from pre-used materials without the approval of the local government	250
12.	4.3(2)	Erect a fence using barbed wire or other material with spiked or jagged projections in fence construction without written approval of the local government	500
13.	4.3(3)	Erect a fence using barbed wire or other material with spiked or jagged projections in a fence at a level lower than 2000mm from the ground	500
14.	5.1(1)	Have or use razor wire in a fence or electrify a fence without having a permit	500
15.	6.1(1)	Failing to comply with the requirements of a notice	500
16.	7.1(2)	All other penalties not specified	250

Dated thisday of2019

The Common Seal of the)
Shire of Northam was)
affixed by authority of a)
resolution of the Council)
in the presence of)

.....
CHRISTOPHER ANTONIO
President

.....
JASON WHITEAKER
Chief Executive Officer

Attachment 3

LOCAL GOVERNMENT ACT 1995

SHIRE OF NORTHAM

PARKING LOCAL LAW 2019

Local Government Act 1995

SHIRE OF NORTHAM

PARKING LOCAL LAW 2019

PART 1 – PRELIMINARY	4
1.1 Title	4
1.2 Commencement	4
1.3 Repeal	4
1.4 Interpretation	4
1.5 Application of particular definitions	9
1.6 Application and pre-existing signs	9
1.7 Classes of vehicles	10
1.8 Part of thoroughfare to which sign applies	10
1.9 Powers of Local Government	10
PART 2 - PARKING BAYS, PARKING STATIONS AND PARKING AREAS	10
2.1 Determination of parking bays, parking stations and parking areas	10
2.2 Vehicles to be within a parking bay	11
2.3 Parking where fees are payable	11
2.4 Parking restrictions in fee paying zones	11
2.5 Parking in a ticket parking zone or ticket parking area	11
2.6 Methods of payment	12
2.7 Reserved fee paying zones	12
2.8 Use of counterfeit or altered parking tickets	12
PART 3 - PARKING GENERALLY	12
3.1 Restrictions on parking in particular areas	12
3.2 Parking and stopping on a carriageway	13
3.3 When parallel and right-angled parking apply	15
3.4 When angle parking applies	15
3.5 Parking of heavy and long vehicles	15
3.6 Authorised Person may order vehicle on thoroughfare to be moved	16
3.7 Authorised Person	16
3.8 No movement of vehicles to avoid time limitation	16
3.9 No parking of vehicles exposed for sale and in other circumstances	16
3.10 Parking on private land	16
3.11 Parking on reserves	17
3.12 Right of ways	17
3.13 Suspension of parking limitations for urgent, essential or official duties	17
PART 4 - PARKING AND STOPPING IN ZONES FOR PARTICULAR VEHICLES	17
4.1 Stopping at intersections	17
4.2 Stopping in a loading zone	18
4.3 Stopping in a taxi zone or a bus zone	18
4.4 Stopping in a mail zone	19
4.5 Construction site vehicle parking	19
4.6 Other limitations in zones	20
PART 5 - OTHER PLACES WHERE STOPPING IS RESTRICTED	20
5.1 Stopping in a shared zone	20
5.2 Double parking	20
5.3 Stopping near an obstruction	20
5.4 Stopping in a bus lane, transit lane or truck lane	21
5.5 Stopping on a bridge, causeway, ramp or in a tunnel	21
5.6 Stopping on crests and curves	21
5.7 Stopping near a fire hydrant	21

5.8	Stopping near a bus stop.....	22
5.9	Stopping on a traffic island	22
5.10	Stopping on a verge.....	22
5.11	Obstructing access to a footpath, path or crossover.....	22
5.12	Stopping near a public letter box.....	23
5.13	Stopping on a carriageway with a bicycle parking sign	23
5.14	Stopping on a carriageway with motorcycle parking sign.....	23
5.15	Stopping on a median strip.....	23
5.16	Eating Areas in parking bays.....	23
PART 6 - PARKING PERMITS.....		23
6.1	Interpretation	23
6.2	Issue of a parking permit	24
6.3	Validity of a parking permit	24
6.4	Revoking a parking permit.....	25
6.5	Where a parking permit applies.....	25
6.6	Return of a parking permit to the local government	26
6.7	Counterfeit or altered parking permit	26
6.8	Replacement of a parking permit.....	26
6.9	Discretionary Authority	26
6.10	Fees payable.....	26
PART 7 - MISCELLANEOUS		26
7.1	Impersonating an Authorised Person	26
7.2	Removal of notices from a vehicle.....	26
7.3	Unauthorised signs and defacing signs	27
7.4	Contravention of signs.....	27
7.5	General provisions about signs	27
7.6	Damage to parking areas and associated infrastructure.....	27
7.7	Special purpose and emergency vehicles	27
7.8	Vehicles not to obstruct a public place.....	27
PART 8 - ENFORCEMENT.....		28
8.1	Offences and penalties.....	28
8.2	Form of notices	28
SCHEDULE 1 - PARKING REGION.....		29
SCHEDULE 2 - PRESCRIBED OFFENCES		30



LOCAL GOVERNMENT ACT 1995

SHIRE OF NORTHAM

PARKING LOCAL LAW 2019

Under the powers conferred by the *Local Government Act 1995* and under all other powers enabling it, the Council of the Shire of Northam resolved on 2019 to make the following local law.

PART 1 – PRELIMINARY

1.1 Title

This local law may be cited as the *Shire of Northam Parking Local Law 2019*.

1.2 Commencement

This local law comes into operation 14 days after the date of publication in the Government Gazette.

1.3 Repeal

The *Shire of Northam Parking and Parking Facilities Local Law 2008* published in the Government Gazette on 16 September 2008 and all amendments thereto are hereby repealed on the day this local law comes into operation.

1.4 Interpretation

In this local law unless the context otherwise requires:

Act means the *Local Government Act 1995*;

Authorised Person means a person authorised by the local government under section 9.10 of the Act, to perform any of the functions of an authorised person under the Act and this local law;

authorised vehicle means a vehicle authorised by the local government, CEO, Authorised Person or by any written law to park on a thoroughfare or parking facility;

bicycle has the meaning given to it by the Code;

bicycle lane has the meaning given to it by the Code;

bus has the meaning given to it by the Code;

bus embayment has the meaning given to it by the Code;

bus stop has the meaning given to it by the Code;

bus zone has the meaning given to it by the Code;

caravan has the meaning given to it in the *Caravan Parks and Camping Grounds Act 1995*

carriageway has the meaning given to it by the Code;

centre has the meaning given to it by the Code;

children's crossing has the meaning given to it by the Code;

CEO means the Chief Executive Officer of the local government

clearway means a length of carriageway which carries a high traffic volume that has 'clearway' or 'no stopping' signs erected appurtenant to it, to facilitate the unhindered flow of traffic;

Code means the *Road Traffic Code 2000*;

coin means any coin which is legal tender pursuant to the *Currency Act 1965 (Commonwealth)*;

commercial vehicle means –

- (a) a motor vehicle constructed for the conveyance of goods or merchandise, or for the conveyance of materials used in any trade, business, industry or work whatsoever, other than a motor vehicle for the conveyance of passengers; and
- (b) includes any motor vehicle that is designed primarily for the carriage of persons, but which has been fitted or adapted for the conveyance of the goods, merchandise or materials referred to, and is in fact used for that purpose.

continuous dividing line means –

- (a) a single continuous dividing line only;
- (b) a single continuous dividing line to the left or right of a broken dividing line; or
- (c) parallel continuous dividing lines;

crossover means an area of the verge, constructed and used for the purpose of enabling a vehicle to access the adjacent property;

disability parking permit has the meaning given in the *Local Government (Parking for People with Disabilities) Regulations 2014*;

district means the district of the local government;

driver has the meaning given to it in the *Road Traffic (Administration) Act 2008*;

eating area means an area in which tables, chairs and other structures are provided for the purpose of the supply of food and beverages to a member of the public or the consumption of food and beverages by a member of the public;

edge line has the meaning given to it by the Code;

emergency vehicle has the meaning given to it by the Code;

fire hydrant has the meaning given to it by the Code;

fee means the prescribed amount of legal tender that the local government may impose and determine from time to time for the stopping or parking of a vehicle under and in accordance with sections 6.16 to 6.19 of the Act;

footpath has the meaning given to it by the Code;

GVM (which stands for 'gross vehicle mass') has the meaning given to it by the *Road Traffic (Administration) Act 2008*;

heavy vehicle has the meaning given to it by the Code;

intersection has the meaning given to it by the Code;

keep clear marking has the meaning given to it by the Code;

kerb means any structure, mark, marking or device to delineate or indicate the edge of a carriageway;

length of carriageway means the same side of the road between intersections on that side of the road;

loading zone has the meaning given to it by the Code;

local government means the Shire of Northam;

long vehicle means a vehicle or any combination of vehicles that, together with any projection or combination of vehicles is 7.5 metres or more in length;

mail zone has the meaning given to it by the Code;

median strip has the meaning given to it by the Code;

metered space means a section or part of a metered zone that is adjacent to a parking meter and that is marked or defined by painted lines or by metallic studs or similar devices for the purpose of indicating where a vehicle may be parked on payment of a fee or charge;

metered zone means any thoroughfare or reserve, or part of any thoroughfare or reserve, in which parking meters regulate the parking of vehicles;

motorcycle has the meaning given to it by the Code;

motor vehicle has the meaning given to it by the *Road Traffic (Administration) Act 2008*;

nature strip has the meaning given to it by the Code;

no parking area has the meaning given to it by the Code;

no parking sign means a sign with the words 'no parking' in red letters on a white background, or the letter 'P' within a red annulus and a red diagonal line across it on a white background;

no stopping area has the meaning given to it by the Code;

no stopping sign means a sign with the words 'no stopping' or 'no standing' in red letters on a white background or the letter 'S' within a red annulus and a red diagonal line across it on a white background;

obstruct means to prevent, hinder, or impede the normal passage of any vehicle, wheelchair, perambulator or pedestrian and 'obstruction' has a corresponding meaning;

occupier has the meaning given to it by the Act;

owner means

- (a) where used in relation to a vehicle licensed under the *Road Traffic Act 1974*, means the person in whose name the vehicle has been registered under that *Road Traffic Act 1974*;
- (b) where used in relation to any other vehicle, means the person who owns, or is entitled to possession of that vehicle; and
- (c) where used in relation to land, has the meaning given to it by the Act;

painted island has the meaning given to it by the Code;

park has the meaning given to it by the Code;

parking area has the meaning given to it by the Code;

parking bay means a section or part of a carriageway or parking station which is marked or defined by painted lines, metallic studs, coloured bricks or pavers or similar devices for the purpose of indicating where a vehicle may be parked;

parking control sign has the meaning given to it by the Code;

parking facilities includes land, buildings, shelters, metered zones, metered spaces, parking stalls and other facilities open to the public generally for the parking of vehicles with or without charge and signs, notices and facilities used in connection with the parking of vehicles;

parking fee payment equipment means a parking meter, parking ticket machine or other; credit/debit card terminal or other device approved by the local government for payment of the applicable parking fee;

parking meter includes the stand on which the meter is erected and a ticket issuing machine;

parking permit means a permit issued by the local government under this local law;

parking ticket means a ticket which is issued from a ticket issuing machine and which

authorises the parking of a vehicle and includes the date and time of which the authorisation expires, whether or not the payment of a fee is required;

parking region means the area described in Schedule 1;

parking scheme means the mapped record of the local government, which details the location of parking facilities, parking bay layout and any parking time restrictions, parking prohibitions and special uses like bus or taxi zones, that are applied to those parking facilities;

parking stall means a section or part of a thoroughfare or of a parking station which is marked or defined by painted lines, metallic studs, coloured bricks or pavers or similar devices for the purpose of indicating where a vehicle may be parked, but does not include a metered space;

parking station means any land, or structure provided for the purpose of parking of multiple vehicles;

path has the meaning given to it by the Code;

pay station means a machine or device within or near a parking station, which accepts payment of the fee for the period a vehicle has been parked and issues a token, ticket or other media to activate a barrier to allow the vehicle to exit from the parking station;

pedestrian has the meaning given to it by the Code;

pedestrian crossing has the meaning given to it by the Code;

postal vehicle has the meaning given to it in the Code;

Private Property Parking Enforcement Agreement means a written agreement between the local government and a property owner or occupier that allows for the enforcement of this local law, or part thereof, upon that property;

property line means the boundary between the land comprising a road and the land that abuts that road;

public place means any place to which the public has access whether or not that place is on private property;

reserve means any land—

- (a) which belongs to the local government;
- (b) of which the local government is the management body under the *Land Administration Act 1997*; or
- (c) which is an 'otherwise unvested facility' within the meaning of section 3.53 of the Act;

right of way means a portion of land that is —

- (a) shown and marked 'Right of Way' or 'R.O.W', or coloured or marked in any other way to signify that the portion of land is a right of way, on any plan or diagram deposited with the Registrar of Titles that is subject to the provisions of section 167A of the *Transfer of Land Act 1893*;
- (b) shown on a diagram or plan of survey relating to a subdivision that is created as a right of way and vested in the Crown under section 152 of the *Planning and Development Act 2005*; or
- (c) shown and marked as a right of way on a map or plan deposited with the Registrar of Titles and transferred to the Crown under the *Transfer of Land Act 1893*, but does not include—
 - (i) a private driveway; or
 - (ii) a right of way created by easement between two parties;

road means a highway, lane, thoroughfare or similar place which the public are allowed to use and includes all of the land including the nature strip and paths appurtenant thereto lying between the property lines abutting the road;

Road Traffic Act means the *Road Traffic Act 1974*;

Road Traffic (Administration) Act means the *Road Traffic (Administration) Act 2008*;

Schedule means a Schedule to this local law;

shared zone has the meaning given to it by the Code;

sign includes a traffic sign, inscription, road marking, mark, structure or device approved by the local government on which may be shown words, numbers, expressions or symbols, and which is placed on or near a thoroughfare or within a parking station or reserve for the purpose of prohibiting, regulating, guiding, directing or restricting the parking of vehicles;

special purpose vehicle has the meaning given to it by the Code;

stop has the meaning given to it by the Code;

symbol includes any symbol specified by the Code;

taxi has the meaning given to it by the Code;

taxi zone has the meaning given to it by the Code;

thoroughfare has the meaning given to it by the Act;

ticket machine means a machine or device which issues, as a result of money or other permitted form of payment being inserted into the machine, a ticket showing the period during which it is lawful to remain parked in the area to which the machine relates;

ticket issuing machine means a parking meter which issues, as a result of money being inserted in the machine or such other form of payment as may be permitted to be made, a ticket showing the period during which it shall be lawful to remain parked in a metered space to which the machine is referable;

ticket parking area means a parking area or facility where a sign applies which indicates a parking fee applies by purchase of a ticket;

tour coach means a vehicle licensed as a Tour Coach and displaying "TC" registration plates, which is hired or chartered to carry passengers for the specific purpose of sight-seeing and/or tourism;

traffic includes the passage of both vehicles and pedestrians;

traffic-control signal has the meaning given to it by the Code;

traffic island has the meaning given to it by the Code;

traffic sign has the meaning given to it by the Code;

trailer has the meaning given to it by the Code;

truck has the meaning given to it by the Code;

unattended means the driver has left the vehicle so that the driver is more than 3 metres from the closest point of the vehicle;

unexpired parking ticket means a parking ticket on which a date and a time is printed and the printed time has not expired;

vehicle has the meaning given to it by the *Road Traffic (Administration) Act 2008*;

verge means the portion of a thoroughfare which lies between the boundary of a carriageway and the adjacent property line but does not include a footpath.

1.5 Application of particular definitions

- (1) For the purposes of the application of the definitions 'no parking area' and 'parking area' an arrow inscribed on a traffic sign erected at an angle to the boundary of the carriageway is deemed to be pointing in the direction in which it would point, if the signs were turned at an angle of less than 90 degrees until parallel with the boundary.
- (2) A reference to a parking station or ticket parking area includes a reference to a part of the parking station or ticket parking area.
- (3) Unless the context otherwise requires, where a term is used, but not defined, in this local law, and that term is defined in the *Road Traffic Act 1974*, *Road Traffic (Administration) Act 2008*, *Road Traffic Code 2000* or in the *Local Government Act 1995*, then the term shall have the meaning given to it in those Acts or the Code.

1.6 Application and pre-existing signs

- (1) Subject to subclause (2), this local law applies to the parking region.
- (2) This local law does not apply to a parking facility or a parking station that is not occupied by the local government, unless the local government and the owner or occupier of that facility or station have agreed in writing that this local law will apply to that facility or station.
- (3) The agreement referred to in subclause (2) may be made on such terms and conditions as the parties may agree.
- (4) Where a parking facility or a parking station is identified in Schedule 3, then the facility or station shall be deemed to be a parking station to which this local law applies and it shall not be necessary to prove that it is the subject of an agreement referred to in subclause (2).
- (5) A sign that –
 - (a) was erected by the local government or the Commissioner of Main Roads prior to the coming into operation of this local law; and
 - (b) relates to the parking of vehicles within the parking region, shall be deemed for the purposes of this local law to have been erected by the local government under the authority of this local law.
- (6) An inscription or symbol on a sign referred to in subclause (5) operates and has effect according to its tenor, and where the inscription or symbol relates to the stopping of vehicles, it shall be deemed for the purposes of this local law to operate and have effect as if it related to the parking of vehicles.

- (7) The provisions of Parts 2, 3, 4 and 5 do not apply to a bicycle parked at a bicycle rail or bicycle rack.

1.7 Classes of vehicles

For the purpose of this local law, vehicles are divided into classes as follows –

- (a) buses;
- (b) commercial vehicles;
- (c) motorcycles and bicycles;
- (d) emergency vehicles;
- (e) special purpose vehicles;
- (f) taxis; and
- (g) all other vehicles.

1.8 Part of thoroughfare to which sign applies

Where under this local law the parking of vehicles in a thoroughfare is controlled by a sign, the sign shall be read as applying to that part of the thoroughfare which –

- (a) lies beyond the sign;
- (b) lies between the sign and the next sign beyond that sign; and
- (c) is on that side of the thoroughfare nearest to the sign.

1.9 Powers of Local Government

The local government may, by resolution, prohibit or regulate by signs or otherwise, the stopping or parking of any vehicle or any class of vehicles in any part of the parking region but must do so consistently with the provisions of this local law.

PART 2 - PARKING BAYS, PARKING STATIONS AND PARKING AREAS

2.1 Determination of parking bays, parking stations and parking areas

- (1) The local government may by Council resolution constitute, determine and vary -
- (a) parking bays;
 - (b) parking stations;
 - (c) parking areas;
 - (d) general no parking or restricted parking zones;
 - (e) permitted time and conditions of parking in parking bays, parking stations and parking areas which may vary with the locality;
 - (f) permitted classes of vehicles which may park in parking bays, parking stations and parking areas;
 - (g) permitted classes of persons who may park in specified parking bays, parking stations and parking areas; and
 - (h) the manner of parking in parking bays, parking stations and parking areas.

- (2) Where the local government makes a determination under subclause (1) it must erect signs to give effect to the determination.
- (3) Where the local government makes a determination or a resolution under subclause (1)(d) it may erect signs at entry points to the general no parking zone indicating the dates and/or days and times during which the area is a general no parking or restricted parking zone.

2.2 Vehicles to be within a parking bay

- (1) Subject to subclauses (2) and (3) a person must not park a vehicle in a parking bay in a parking area or parking station otherwise than –
 - (a) if the parking area is within a carriageway, parallel to and as close to the kerb as is practicable;
 - (b) wholly within the parking bay; and
 - (c) if the parking area is within a carriageway, headed in the direction of the movement of traffic on the side of the carriageway in which the bay is situated.
- (2) If a vehicle is too long or too wide to fit completely within a single parking bay then the person parking the vehicle must do so within the minimum number of parking bays needed to park that vehicle.
- (3) A person must not park a vehicle partly within and partly outside a parking area.

2.3 Parking where fees are payable

A person must not park a vehicle, or permit a vehicle to remain parked, in a parking station or parking area where a permissive parking sign indicates that a fee is payable, unless –

- (a) the vehicle is parked in compliance with any instructions on or with the sign, or parking fee payment equipment; and
- (b) the appropriate fee is paid for each parking bay that the vehicle occupies.

2.4 Parking restrictions in fee paying zones

A person must not park a vehicle in a fee paying zone except in accordance with signs referable to the zone.

2.5 Parking in a ticket parking zone or ticket parking area

A person must not park a vehicle, except a motorcycle in a motorcycle bay, in a parking zone, parking area or parking station which is equipped with a parking ticket machine without–

- (a) purchasing or obtaining a ticket, from the ticket machine for that area, which remains valid for the period the vehicle is parked; and
- (b) displaying the ticket inside the vehicle in a prominent position, in such a manner as to be clearly visible from the front of the vehicle at all times while that vehicle remains parked in that ticket parking zone, ticket parking area or parking station.
- (c) If a parking ticket machine allows for number plate recognition, a person must purchase a ticket for a motorcycle.

2.6 Methods of payment

- (1) The local government may introduce and apply methods of payment for parking fees which may include but not be limited to payment by –
 - (a) Australian currency including coins and or bank notes;
 - (b) credit or debit card;
 - (c) payment by telephone; or
 - (d) any other approved method of payment.
- (2) The local government may introduce various paid parking processes which may include but not be limited to the following –
 - (a) ticket parking;
 - (b) pay by vehicle registration number; or
 - (c) pay by parking bay.

2.7 Reserved fee paying zones

Unless authorised by the local government a person must not leave or permit a vehicle to remain stopped or parked in a fee paying space or zone if the parking meter or ticket issuing machine is hooded with a cover bearing the words No Parking, Reserved Parking, Temporary Bus Stop, No Stopping, Tow Away Zone or with an equivalent symbol, depicting one of these purposes or any other words or symbols that indicate parking is not permitted within the space or zone including temporary signage.

2.8 Use of counterfeit or altered parking tickets

A person must not –

- (a) park a vehicle in a parking facility which requires a parking ticket, if there is displayed in that vehicle so as to be visible from outside the vehicle, a parking ticket which has been counterfeited, altered, obliterated or interfered with; or
- (b) produce to an Authorised Person who accepts payment for parking, a parking ticket which has been counterfeited, altered, obliterated or interfered with.

PART 3 - PARKING GENERALLY

3.1 Restrictions on parking in particular areas

- (1) A person must not park a vehicle in a parking station or part of a parking station or parking area–
 - (a) if by a sign it is set apart for the parking of vehicles of a different class;
 - (b) if by a sign it is set apart for the parking of vehicles by persons displaying a valid parking permit; or
 - (c) during any period when the parking of vehicles is prohibited by a sign, but does not include a clearway.
- (2) Unless a sign or road markings indicate otherwise a person must not park any portion of a vehicle in a parking station or parking area–
 - (a) for more than the maximum time specified;
 - (b) in a bay marked 'M/C' unless it is a motorcycle without a sidecar or a trailer;

- (c) so as to obstruct an entrance to or an exit from a parking station, or an access way within a parking station; or
 - (d) park or attempt to park a vehicle in a parking bay in which another vehicle is parked.
- (3) Notwithstanding the provisions of subclause (2)(a), a person may park a vehicle in a permissive parking bay or station (except in a parking area for people with disabilities) for twice the length of time allowed, provided that—
- (a) the person's vehicle displays a current disability parking permit sticker; and
 - (b) a disabled person to whom that disability parking permit sticker relates, is either the driver or a passenger in the vehicle.
- (4) A person must not park a vehicle or permit a vehicle to remain parked in a parking facility controlled by a sign stating 'Authorised Vehicles Only', without –
- (a) a valid permit displayed inside the vehicle that must be displayed in a prominent position, in such a manner as to be clearly visible from the front of the vehicle; or
 - (b) prior written permission of the local government or an Authorised Person to park within the area has been obtained and the written permission is displayed in a prominent position, in such a manner as to be clearly visible from the front of the vehicle to indicate it has authorisation to park.

3.2 Parking and stopping on a carriageway

- (1) Subclauses (4)(b), (d), (h) and (i) do not apply to a bus which stops in a bus embayment.
- (2) A person parking a vehicle on a carriageway other than in a parking bay must park it—
- (a) in the case of a two-way carriageway, so that it is as near as practicable to and parallel with, the left boundary of the carriageway and headed in the direction of the movement of traffic on the side of the carriageway on which the vehicle is parked;
 - (b) in the case of a one-way carriageway, so that it is as near as practicable to and parallel with either boundary of the carriageway and headed in the direction of the movement of traffic;
 - (c) so that at least 3 metres of the width of the carriageway lies between the vehicle and the farther boundary of the carriageway, or median strip, or between the vehicle and a vehicle parked on the farther side of the carriageway;
 - (d) so that the front and the rear of the vehicle respectively is not less than 1 metre from any other vehicle, except a motorcycle without a trailer, or a bicycle parked in accordance with this local law;
 - (e) so that it does not obstruct any vehicle on the carriageway, or
 - (f) so that the vehicle is not faced against the normal flow of traffic on that side of the carriageway;
- unless otherwise indicated on a parking control sign or markings on the carriageway.
- (3) A person must not stop a vehicle on a carriageway or any part of a carriageway –
- (a) if the parking of a vehicle is prohibited at all times by a sign; or
 - (b) during a period in which the parking of vehicles on that part is prohibited by a sign.

- (4) A person must not stop a vehicle on a carriageway so that any portion of the vehicle—
- (a) is on or adjacent to a median strip;
 - (b) obstructs a private drive or carriageway or so close as to deny a vehicle reasonable access to or egress from the right of way, private drive or carriageway;
 - (c) is alongside or opposite any excavation, works, hoarding, scaffolding or obstruction on the carriageway if the vehicle would obstruct traffic;
 - (d) is on or within 10 metres of any portion of a carriageway bounded by a traffic island;
 - (e) is on any pedestrian crossing;
 - (f) is within 10 metres of the departure side or within 20 metres of the approach side of a children's crossing or pedestrian crossing;
 - (g) is within 20 metres of either the approach side or the departure side of the nearest rail of a railway level crossing;
 - (h) is between the boundaries of a carriageway and any double longitudinal line consisting of two continuous dividing lines or a continuous dividing line and a broken or dotted line, unless there is a distance of at least 3 metres clear between the vehicle and the nearer continuous dividing line; or
 - (i) is contrary to a clearway sign referable to that part,
- unless the person stops the vehicle at a place on a length of carriageway, or in an area, to which a parking control sign applies and the person is permitted to stop at that place under this local law.
- (5) A person must not stop a vehicle on a carriageway –
- (a) if the parking of a vehicle is prohibited at all times by a sign; or
 - (b) during a period in which the parking of vehicles on that part is prohibited by a sign;
 - (c) or in an area to which a 'no stopping' sign applies;
 - (d) marked with a continuous yellow edge line;
 - (e) if by a sign it is set apart for the parking of vehicles of a different class; or
 - (f) if by a sign it is set apart for the parking of vehicles by persons of a different class,
- unless the person stops the vehicle at a place on a length of carriageway, or in an area, to which a parking control sign applies and the person is permitted to stop at that place under this local law.
- (6) A person must not park a vehicle on a length of carriageway or in an area to which a 'no parking' sign applies, unless the driver—
- (a) is dropping off, or picking up, passengers or goods;
 - (b) does not leave the vehicle unattended; and
 - (c) completes the dropping off, or picking up, of the passengers or goods within 2 minutes of stopping and drives on.

3.3 When parallel and right-angled parking apply

- (1) Where a traffic sign associated with a parking area is not inscribed with the words 'angle parking' (or with an equivalent symbol depicting this purpose), then unless a sign associated with the parking area indicates, or marks on the carriageway indicate, that vehicles have to park in a different position, where the parking area is –
 - (a) adjacent to the boundary of a carriageway, a person parking a vehicle in the parking area must park it as near as practicable to and parallel with that boundary; or
 - (b) at or near the centre of the carriageway, a person parking a vehicle in that parking area must park it at approximately right angles to the center of the carriageway.
- (2) Clause 3.3(1)(a) does not apply to the rider of a motorcycle if the rider positions the motorcycle so at least one wheel is as near as practicable to the far left or far right side of the carriageway.

3.4 When angle parking applies

- (1) This clause does not apply to –
 - (a) a passenger vehicle or a commercial vehicle with a mass including any load, of over three tonnes; or
 - (b) a person parking a motorcycle without a trailer.
- (2) Where a sign associated with a parking area is inscribed with the words 'angle parking' (or with an equivalent symbol depicting this purpose), a person parking a vehicle in the area must park the vehicle at an angle of approximately 45 degrees to the centre of the carriageway unless otherwise indicated by the inscription on the parking sign or marks on the carriageway that indicate the required angle of parking.
- (3) Where a sign associated with an angle parking area is inscribed with the words 'reverse in' a person parking a vehicle in the area must reverse the vehicle into the parking bay so that the vehicle is driven forward when it is leaving the parking bay.

3.5 Parking of heavy and long vehicles

- (1) A person must not park a heavy or long vehicle –
 - (a) on a carriageway for any period exceeding one hour, unless actively engaged in the loading or unloading of goods; or
 - (b) on a carriageway except on the shoulder of the carriageway, or in a truck bay or other area set aside for the parking of heavy or long vehicles.
- (2) Nothing in this clause mitigates the limitations or condition imposed by any other clause in this local law, any other written law or traffic sign relating to the parking or stopping of vehicles.

3.6 Authorised Person may order vehicle on thoroughfare to be moved

A person must not park a vehicle on any part of a thoroughfare in contravention of this local law after an Authorised Person has directed that person to move the vehicle.

3.7 Authorised Person

- (1) An Authorised Person may –
 - (a) mark the tyres of a vehicle parked in a parking facility with chalk or any other non-indelible substance for a purpose connected with or arising out of his or her duties or powers;
 - (b) take a valve stem reading of the vehicle;
 - (c) record vehicle registration numbers; and
 - (d) place a notice or parking fact sheet upon a vehicle.
- (2) A person must not remove a mark made by an Authorised Person so that the purpose of the affixing of such a mark is defeated or likely to be defeated.
- (3) An Authorised Person may in the course of performing his/her duties, park contrary to the provisions of a parking control sign for the minimum amount of time required to complete those duties.

3.8 No movement of vehicles to avoid time limitation

- (1) Where the parking of vehicles in a parking facility is permitted for a limited time, a person must not move a vehicle within the parking facility so that the total time of parking exceeds the maximum time allowed for parking in the parking facility, unless the vehicle has first been removed from the parking facility for at least one hour.
- (2) Where the parking of vehicles in a thoroughfare is permitted for a limited time, a person must not move a vehicle along a section of thoroughfare so that the total time of parking exceeds the maximum time permitted, unless the vehicle has first been removed from that section of thoroughfare for at least one hour.
- (3) For the purposes of this local law a section of thoroughfare ends and another begins whenever an intersecting carriageway occurs.

3.9 No parking of vehicles exposed for sale and in other circumstances

A person must not park a vehicle on any portion of a thoroughfare–

- (a) for the purpose of exposing it for sale or hire;
- (b) if that vehicle is not licensed under the *Road Traffic Act 1974*;
- (c) if that vehicle is a trailer or a caravan unattached to a motor vehicle;
- (d) for the purpose of effecting repairs to it, other than the minimum repairs necessary to enable the vehicle to be moved to a place other than a thoroughfare.

3.10 Parking on private land

- (1) In this clause, a reference to 'land' does not include land –
 - (a) which belongs to the local government;
 - (b) of which the local government is the management body under the *Land Administration Act 1997*; or

- (c) which is an 'otherwise unvested facility' within section 3.53 of the Act.
- (2) A person must not park a vehicle on private land without the consent of the owner or occupier of the land on which the vehicle is parked.
- (3) Where the owner or occupier of private land, by a sign referable to that land or otherwise, consents to the parking of vehicles of a specified class or classes on the land for a limited period, a person must not park a vehicle on the land otherwise than in accordance with the consent.
- (4) The owner or occupier of private land must not permit a private property parking enforcement agreement sign to remain erected and visible to the public if the owner or occupier no longer has a current private property parking enforcement agreement with the local government.

3.11 Parking on reserves

No person other than an employee of the local government in the course of his or her duties or a person authorised by the local government may drive or park a vehicle upon or over any portion of a reserve other than upon an area specifically set aside for that purpose.

3.12 Right of ways

A person must not stop or park a vehicle at any time in a right of way so as to cause an obstruction or so as to prevent a vehicle reasonable access to or egress from the right of way.

3.13 Suspension of parking limitations for urgent, essential or official duties

- (1) Where by a sign the parking of vehicles is permitted for a limited time on a portion of a thoroughfare or parking facility, the local government or an Authorised Person, may, subject to the Code, permit a person to park a vehicle in that portion of the thoroughfare or parking facility for longer than the permitted time in order that the person may carry out urgent, essential or official duties.
- (2) Where permission is granted under subclause (1), the local government or an Authorised Person may prohibit the use by any other vehicle of that portion of the thoroughfare or parking facility to which the permission relates, for the duration of that permission.
- (3) An Authorised Person may, in the course of performing his or her duties, park a vehicle contrary to a sign or other restriction in this local law for the minimum amount of time required to complete those duties.

PART 4 - PARKING AND STOPPING IN ZONES FOR PARTICULAR VEHICLES

4.1 Stopping at intersections

- (1) A person must not stop any portion of a vehicle on a thoroughfare within 20 metres from the nearest point of an intersecting carriageway at an intersection with traffic-control signals, unless the person stops at a place on a length of thoroughfare, or in an area, to which a parking control sign applies and the person is permitted to stop at the place under this local law.
- (2) A person must not stop any portion of a vehicle on a thoroughfare so that any portion of the vehicle is within 10 metres of the prolongation of the nearer edge of any

intersecting carriageway (without traffic-control signals) intersecting that carriageway on the side on which the vehicle is stopped, unless the person stops—

- (a) at a place on the thoroughfare, or in an area, to which a parking control sign applies and the person is permitted to stop at that place under this local law; or
- (b) if the intersection is a T- intersection – along the continuous side of the continuing carriageway at the intersection.

4.2 Stopping in a loading zone

A person must not stop a vehicle in a loading zone –

- (a) unless it is a commercial vehicle continuously engaged in the picking up or setting down of goods;
- (b) (if no time is indicated on the sign) for longer than a time indicated on the loading zone sign; or
- (c) for longer than 30 minutes.

4.3 Stopping in a taxi zone or a bus zone

- (1) A person must not stop a vehicle in a taxi zone, unless that person is driving a taxi.
- (2) A person must not stop a vehicle in a bus zone unless that vehicle is a bus that is permitted to stop at the bus zone by information on or with the 'bus zone' sign applying to the bus zone.

4.4 Stopping in a mail zone

A person must not stop a vehicle in a mail zone unless authorised under a written law.

4.5 Construction site vehicle parking

(1) In this clause unless the context otherwise requires–

builder has the meaning given to it in the *Building Act 2011*;

construction site means any land subject to development;

construction site vehicle means a commercial vehicle, truck heavy or long vehicle;

daily fee means the applicable daily fee as determined in accordance with section 6.16 of the Act;

development means the demolition, erection, construction, alteration of or addition to any building or structure on land or the carrying out on land of any excavation or other works;

eligible person means an owner or occupier of a construction site or any builder carrying out work on a construction site;

establishment fee means the applicable establishment fee as determined in accordance with section 6.16 of the Act;

work zone means any carriageway or part of a carriageway, whether or not marked as a metered space, parking bay or ticket machine zone, which is set aside by the local government by a sign, for a period specified on the sign, for the stopping or parking of construction site vehicles –

(2) An eligible person seeking to establish a work zone adjacent to a construction site may apply in writing to the local government, which may approve or refuse the application.

(3) Where the local government approves an application, it is to give the applicant written notice specifying –

- (a) the number and location of work zones the applicant may use;
- (b) the times during which the stopping or parking of construction site vehicles is permitted in the work zone;
- (c) the period for which the approval is valid;
- (d) any conditions to which the approval of the local government is subject; and
- (e) the amount of the establishment fee and daily fee applicable.

(4) The local government is to set aside a work zone in accordance with the notice referred to in subclause (3) within 14 days from the date of payment of the establishment fee.

(5) An eligible person must, in addition to the establishment fee, pay to the local government a daily fee for each day that a work zone is set aside.

(6) The daily fee is payable monthly in advance.

(7) Where the local government has approved an application to establish a work zone adjacent to a construction site, the local government may cancel its approval by written notice to the applicant in the event that, the applicant or any person authorised by the applicant to use the work zone stops or parks a vehicle other than in accordance with–

- (a) any condition stipulated in the notice issued to the applicant pursuant to subclause (3);
- (b) any sign applicable to the work zone;

- (c) the applicant fails to pay the daily fee as required pursuant to subclause (5); or
 - (d) if the local government or a person authorised by the local government requires access to or near the place where the work zone is situated, for the purposes of carrying out works in or near the vicinity of that place.
- (8) A person must not stop or park a vehicle in a work zone unless the person is driving a vehicle that is –
- (a) engaged in construction work in or near the zone; or
 - (b) permitted to stop in the works zone in accordance with this local law.

4.6 Other limitations in zones

A person must not stop a vehicle in a zone to which a traffic sign applies if stopping the vehicle would be contrary to any limitation in respect to classes of persons or vehicles, or specific activities allowed, as indicated by additional words on a traffic sign that applies to the zone.

PART 5 - OTHER PLACES WHERE STOPPING IS RESTRICTED

5.1 Stopping in a shared zone

A person must not stop a vehicle in a shared zone unless –

- (a) the person stops a vehicle at a place on a length of carriageway, or in an area, to which a parking control sign applies and the person is permitted to stop at that place under this local law;
- (b) the person stops a vehicle in a parking bay and the person is permitted to stop in the parking bay under this local law; or
- (c) the person is engaged in door-to-door delivery or collection of goods, or in the collection of waste or garbage.

5.2 Double parking

- (1) A person must not stop a vehicle so that any portion of the vehicle is between any other stopped vehicle and the centre of the carriageway.
- (2) This clause does not apply to –
 - (a) a vehicle stopped in traffic; or
 - (b) a vehicle angle parking on the side of the carriageway or in a median strip parking area, in accordance with this local law.

5.3 Stopping near an obstruction

A person must not stop a vehicle on a carriageway near an obstruction on the carriageway in a position that further obstructs traffic on the carriageway.

5.4 Stopping in a bus lane, transit lane or truck lane

A driver must not stop in –

- (a) a bus lane;
- (b) a transit lane;
- (c) a truck lane; or
- (d) a bicycle lane,

unless the driver is driving a public bus or taxi, and is dropping off, or picking up, passengers.

5.5 Stopping on a bridge, causeway, ramp or in a tunnel

(1) A person must not stop a vehicle on a bridge, causeway, ramp or similar structure unless –

- (a) the carriageway is at least as wide on the structure as it is on each of the approaches and a sign does not prohibit stopping or parking; or
- (b) the person stops a vehicle at a place on a length of carriageway, or in an area to which a parking control sign applies and the person is permitted to stop at that place under this local law.

(2) A person must not stop a vehicle in a tunnel or underpass unless –

- (c) the carriageway is at least as wide in the tunnel or underpass as it is on each of the approaches and a sign does not prohibit stopping or parking; or
- (d) the vehicle is a bus stopped at a bus stop, or in a bus zone or parking area marked on the carriageway, for the purpose of setting down or taking up passengers.

5.6 Stopping on crests and curves

(1) Subject to subclause (2), a person must not stop a vehicle on, or partly on, a carriageway within the parking region, in any position where it is not visible to the driver of an overtaking vehicle, from a distance of 50 metres.

(2) A person may stop a vehicle on a crest or curve on a carriageway within the parking region if the vehicle stops at a place on the carriageway, or in an area, to which a parking control sign applies and the vehicle is permitted to stop at that place under this local law.

5.7 Stopping near a fire hydrant

A person must not stop a vehicle so that any portion of the vehicle is within 1 metre of a fire hydrant or fire plug or of any sign or mark indicating the existence of a fire hydrant or fire plug, unless –

- (a) the person is driving a public bus, and stops in a bus zone or at a bus stop and does not leave the bus unattended; or
- (b) the person is driving a taxi and stops in a taxi zone and does not leave the taxi unattended.

5.8 Stopping near a bus stop

- (1) A person must not stop a vehicle so that any portion of the vehicle is within 20 metres of the approach side of a bus stop or within 10 metres of the departure side of a bus stop, unless –
 - (a) the vehicle is a public bus stopped to take up or set down passengers; or
 - (b) the person stops at a place on a length of carriageway, or in an area, to which a parking control sign applies and the person is permitted to stop at that place under this local law.
- (2) In this clause a trailer attached to a public bus is deemed to be a part of the public bus.

5.9 Stopping on a traffic island

A person must not stop a vehicle (other than a bicycle) so that any portion of the vehicle is on a traffic island, unless the vehicle stops in an area to which a parking control sign applies and the vehicle is permitted to stop at that place under this local law.

5.10 Stopping on a verge

- (1) A person must not stop –
 - (a) a vehicle (other than a bicycle);
 - (b) a commercial vehicle, a bus, a trailer, a boat, a caravan, a truck or any other vehicle with a GVM in excess of 2.5 tonnes or 7.5 metres in length; or
 - (c) a vehicle during any period when stopping of vehicles on that verge is prohibited by a sign adjacent and referable to that verge,
so that any portion of it is on a verge.
- (2) Subclause (1)(a) does not apply to the driver if he or she is the owner or occupier of a premises that abuts the verge or is a person authorised by the owner or occupier of those premises to park the vehicle so that any portion of it is on the verge.
- (3) Subclause (1)(b) does not apply to a commercial vehicle when it is being loaded or unloaded with reasonable expedition with goods or materials collected from or delivered to the premises that abuts the verge on which the commercial vehicle is parked, (but in any event not for any period exceeding 3 consecutive hours between the hours of 7am and 6pm Western Australian Standard Time and not at any other time), provided no obstruction is caused to the passage of any other vehicle or person using a carriageway or path.
- (4) Notwithstanding subclause (2) and (3), clause 4.1 applies.

5.11 Obstructing access to a footpath, path or crossover

- (1) A person must not stop a vehicle so that any portion of the vehicle is on or across a footpath, path or in a position that it obstructs access or egress by pedestrians using that footpath or path or other vehicles to that path, unless –
 - (a) the driver is dropping off or picking up passengers and must not remain for longer than 2 minutes; or
 - (b) the driver stops in a parking bay and the driver is permitted to stop in the parking bay under this local law.
- (2) A person must not stop a vehicle on or across a crossover or other way of access for vehicles travelling to or from adjacent land, unless –

- (a) the vehicle is dropping off, or picking up, passengers and must not remain for longer than 2 minutes;
 - (b) the vehicle stops in a parking bay and the vehicle is permitted to stop in the parking bay under this local law; or
 - (c) the driver is the owner or occupier of the premises that abuts the crossover or is a person permitted by the owner or occupier of the premises.
- (3) A person must not park a vehicle on a crossover if any portion of the vehicle obstructs a footpath or prolongation thereof.

5.12 Stopping near a public letter box

A person must not stop a vehicle other than a postal vehicle, so that any portion of the vehicle is within 3 metres of a public letter box, unless the vehicle stops at a place on a length of carriageway, or in an area, to which a parking control sign applies and the vehicle is permitted to stop at that place under this local law.

5.13 Stopping on a carriageway with a bicycle parking sign

A person must not stop a vehicle (other than a bicycle) on a length of carriageway to which a 'bicycle parking' sign applies, unless the vehicle is dropping off or picking up passengers.

5.14 Stopping on a carriageway with motorcycle parking sign

A person must not stop a vehicle on a length of carriageway, or in a parking bay to which a 'motorcycle parking' sign applies, or an area marked 'M/C', unless the vehicle is a motor cycle.

5.15 Stopping on a median strip

A person must not stop a vehicle (other than a bicycle) so that any portion of the vehicle is on a median strip, unless the vehicle stops in an area to which a parking control sign applies and the vehicle is permitted to stop at that place under this local law.

5.16 Eating Areas in parking bays

A person must not stop a vehicle in a parking bay which has been authorised in writing by the local government, to be set up or conducted as an eating area and which is designated by signs as such at that time.

PART 6 - PARKING PERMITS

6.1 Interpretation

In this part of this Local Law, unless the context requires otherwise –

Commercial Parking Permit means a permit issued by the local government pursuant to clause 6.2(3).

dwelling unit means premises lawfully used for self-contained living quarters.

eligible person means the owner of a vehicle registered under the *Road Traffic Act* at the address shown on the application for the parking permit, where used:

- (a) in relation to an application for a residential parking permit means a single house occupier, a unit occupier, a unit owner;
- (b) in relation to an application for a visitor's parking permit means –

- (i) a single house occupier;
 - (ii) a strata company; or
 - (iii) a unit owner of a residential unit which is not a strata lot;
- (c) in relation to an application for a commercial parking permit means the proprietor of a commercial business.

Residential Parking Permit means a permit issued by the local government pursuant to Clause 6.2(1).

Residential Unit means a dwelling unit which is part of a building adjacent to a part of a road on which the stopping or parking of vehicles is prohibited for more than a specified period and which building contains –

- (a) 2 or more dwelling units with or without any non-residential units; or
- (b) 1 dwelling unit with one or more non-residential units.

single house means a dwelling unit constructed on its own lot and used for self-contained living quarters and which is adjacent to a part of a road on which the stopping or parking of vehicles is prohibited for more than a specified period.

single house occupier means an occupier of a single house.

strata company means a body corporate constituted under section 32 of the *Strata Titles Act 1985*.

unit occupier means an occupier of a residential unit but does not include a unit owner.

unit owner means a person who is the owner of a residential unit.

Visitors Parking Permit means a permit issued by the local government pursuant to Clause 6.2(2).

6.2 Issue of a parking permit

- (1) The local government may upon a written application of an eligible person issue a residential parking permit in the prescribed form approved by the local government and for the prescribed fee.
- (2) The local government may upon a written application of an eligible person issue a visitor's parking permit in the prescribed form approved by the local government and for the prescribed fee.
- (3) The local government may upon a written application of an eligible person issue a commercial parking permit in the prescribed form approved by the local government and for the prescribed fee.
- (4) The local government's power to issue, replace and revoke permits under this Part may be exercised by an Authorised Person.

6.3 Validity of a parking permit

Every parking permit as the case may be, must cease to be valid upon –

- (a) On 31 December of the year of expiry of a period of either 1 or 3 years (depending upon the permit issued) from and including the date on which it is issued;
- (b) the holder of the permit ceasing to be an eligible person;
- (c) the revocation of the permit by the local government pursuant to clause 6.4; or
- (d) the replacement of any permit by a new permit issued by the local government

pursuant to clause 6.2.

6.4 Revoking a parking permit

- (1) The local government may revoke a parking permit if the permit holder breaches any of the conditions for its use or the prerequisites for the issue of the permit no longer apply.
- (2) The local government may at any time give an eligible person to whom a permit was issued pursuant to the provisions of this local law a notice of intention in the prescribed form approved by the local government requiring that person to notify the local government of any reason why that permit should not be revoked.
- (3) The local government must give notice referred to in subclause (2) by serving a notice of intention on the eligible person to whom the permit was issued.
- (4) If within 7 days after the date of receipt of the notice of intention referred to in subclause (2) the eligible person to whom the permit was issued –
 - (i) fails to give the local government notice in writing of any reason why the permit should not be revoked;
 - (ii) gives the local government notice in writing of any reasons why the permit should not be revoked,then the local government may in its absolute discretion revoke that permit.
- (5) For the purpose of subclause (2) the date of receipt of the notice must be the date the notice was served.
- (6) The local government must give notice in the prescribed form of the revocation by serving a notice of revocation on the eligible person to whom the permit was issued.

6.5 Where a parking permit applies

- (1) Where the parking of a vehicle on any part of a carriageway within the parking region is prohibited for more than a specified time, or in a ticket parking zone without an unexpired parking ticket being displayed within the vehicle, or in a parking fee zone requiring the fee to be paid, the holder of a permit issued under this clause is exempt from such prohibition, provided that such exemption must only apply –
 - (a) to the part of the carriageway specified in the permit;

- (b) if the permit is displayed inside the vehicle in a prominent position, in such a manner as to be clearly visible from the front of the vehicle;
 - (c) if the permit was validly issued and has not expired; and
 - (d) if the permit holder occupies the premises in respect of which the permit is issued.
- (2) A person must not stop or park a vehicle in an area set aside for persons or vehicles of a particular class during any permitted period unless a permit is displayed inside the vehicle in a prominent position, in such a manner as to be clearly visible from the front of the vehicle and able to be read by an Authorised Person at all times while the vehicle remains stopped or parked in the zone.

6.6 Return of a parking permit to the local government

A parking permit holder who ceases to occupy the premises or own a vehicle for which a parking permit was issued, must remove any permit displayed in or affixed to the windscreen of any vehicle and return the permit(s) to the local government.

6.7 Counterfeit or altered parking permit

A person must not use or display in a vehicle, a parking permit that has in any way been counterfeited, altered, obliterated or interfered with.

6.8 Replacement of a parking permit

The local government may issue a replacement residential, visitors or commercial parking permit when a written application is made and the appropriate fee is paid.

6.9 Discretionary Authority

Notwithstanding any other provisions in this local law or a policy adopted by the local government which restricts the number of parking permits that may be issued, the local government may approve the issue of additional parking permits to any eligible person on such terms and conditions as the local government sees fit.

6.10 Fees payable

Fees payable for the issue of a permit must be determined in accordance with section 6.16 to 6.19 of the Act.

PART 7 – MISCELLANEOUS

7.1 Impersonating an Authorised Person

A person who is not an Authorised Person of the local government must not impersonate or assume the duties of an Authorised Person.

7.2 Removal of notices from a vehicle

A person, other than the owner or driver of the vehicle or a person acting under the direction of the owner or driver of the vehicle, must not remove from the vehicle any notice put on the vehicle by an Authorised Person.

7.3 Unauthorised signs and defacing signs

A person must not without the authority of the local government –

- (a) mark, set up or exhibit a sign purporting to be or resembling a sign marked, set up or exhibited by the local government under this local law;
- (b) remove, deface or misuse a sign or property, set up or exhibited by the local government under this local law or attempt to do any such act; or
- (c) affix a board, sign, placard, notice or other thing to or paint or write upon any part of a sign set up or exhibited by the local government under this local law.

7.4 Contravention of signs

An inscription or symbol on a sign operates and has effect according to its tenor and a person contravening the direction on a sign commits an offence under this local law.

7.5 General provisions about signs

A sign marked, erected, set up, established or displayed on or near a thoroughfare is, in the absence of evidence to the contrary presumed to be a sign marked, erected, set up, established or displayed under the authority of this local law.

7.6 Damage to parking areas and associated infrastructure

- (1) A person must not, nor attempt to, remove, damage, deface, misuse or interfere with any part of a parking station, parking facility, parking area or any infrastructure appurtenant to those areas.
- (2) A person must not operate or attempt to operate a ticket issuing machine or pay station except in accordance with the operating instructions appearing on those devices.

7.7 Special purpose and emergency vehicles

Notwithstanding anything to the contrary in this local law, the driver of –

- (a) a special purpose vehicle may, only in the course of performing his or her duties and when it is expedient and safe to do so, stop or park the vehicle in any place, at any time; and
- (b) an emergency vehicle may, in the course of performing his or her duties and when it is expedient and safe to do so or where he or she honestly and reasonably believes that it is expedient and safe to do so, stop or park the vehicle at any place, at any time.

7.8 Vehicles not to obstruct a public place

- (1) A person must not park or leave a vehicle, or any part of a vehicle, in a public place so that it obstructs the use of any part of that public place without the permission of the local government or unless authorised under any written law.
- (2) A vehicle which is parked in any portion of a public place where vehicles may be lawfully parked, is deemed to cause an obstruction and may be impounded where –
 - (a) the vehicle is parked for any period exceeding 24 hours;
 - (b) the vehicle is so parked during any period in which the parking of vehicles is prohibited or restricted by a sign; or
 - (c) the vehicle is abandoned, unregistered or disused.
- (3) The powers of the local government to remove and impound vehicles are set out in Part 3 Division 3 Subdivision 4 of the Act.

PART 8 – ENFORCEMENT

8.1 Offences and penalties

- (1) Any person who fails to do anything required or directed to be done under this local law, or who does anything, which under this local law that person is prohibited from doing, commits an offence.
- (2) An offence against any provision of this local law is a prescribed offence for the purposes of section 9.16(1) of the Act.
- (3) Any person who commits an offence under this local law is to be liable, upon conviction, to a penalty not less than \$1000 and not exceeding \$5,000 and if the offence is of a continuing nature, to an additional penalty not exceeding \$500 for each day or part of a day during which the offence has continued.
- (4) The amount appearing in the final column of Schedule 2 directly opposite a clause specified in that Schedule is the modified penalty for an offence against that clause.

8.2 Form of notices

For the purposes of this local law –

- (a) the form of the notice referred to in section 9.13 of the Act is that of Form 1 in Schedule 1 of the *Local Government (Functions and General) Regulations 1996*;
- (b) the form of the infringement notice referred to in section 9.17 of the Act is that of Form 2 in Schedule 1 of the *Local Government (Functions and General) Regulations 1996*; and
- (c) the form of the infringement withdrawal notice referred to in section 9.20 of the Act is that of Form 3 in Schedule 1 of the *Local Government (Functions and General) Regulations 1996*.

SCHEDULE 1 - PARKING REGION

[Clause 1.7(1)]

The parking region is the whole of the district, but excludes the following portions of the district:

- (1) the approach and departure prohibition areas of all existing and future traffic control signal installations as determined by the Commissioner of Main Roads;
- (2) prohibition areas applicable to all existing and future bridges and subways as determined by the Commissioner of Main Roads; and
- (3) any road which comes under the control of the Commissioner of Main Roads unless the control of parking and parking facilities on that road is carried out subject to the control and direction of the Commissioner of Main Roads or has been delegated by the Commissioner to the local government.

SCHEDULE 2 - PRESCRIBED OFFENCES

[Clause 8.1(4)]

Item No.	Clause No.	Nature of offence	Modified Penalty \$
1.	2.2(1)(b)	Failure to park wholly within a parking bay	80
2.	2.2(1)(c)	Parking against the flow of traffic	80
3.	2.2(3)	Failure to park wholly within a parking area	80
4.	2.3(a)	Parking in fee paying area contrary to instructions	80
5.	2.3(b)	Failure to pay the required fees	80
6.	2.4	Parking contrary to signage where fees are payable	80
7.	2.5(a)	Parking with an expired parking ticket	80
8.	2.5(b)	Failing to clearly display parking ticket	80
9.	2.7	Stopping a vehicle when stopping is not permitted within a fee paying zone	80
10.	2.8	Use counterfeit or altered parking ticket	250
11.	3.1(1)(a)	Parking wrong class of vehicle	80
12.	3.1(1)(b)	Parking by persons of a different class	80
13.	3.1(1)(c)	Parking during prohibited period, excluding clearways	80
14.	3.1(2)(a)	Parking in excess of maximum time	80
15.	3.1(2)(b)	Parking vehicle in a motorcycle only area	80
16.	3.1(2)(c)	Causing obstruction in a parking station	80
17.	3.1(2)(d)	Parking or attempting to park a vehicle in a parking bay occupied by another vehicle	80
18.	3.1(4)	Parking without permission in an area designated for 'Authorised Vehicles Only'	100
19.	3.2(2)(a)	Failure to park as near as practicable to the left side of the carriageway	80
20.	3.2(2)(b)	Failure to park as near as practicable to the side of the carriageway along a one way carriageway	80
21.	3.2(2)(c)	Parking within 3 metres of the farther carriageway boundary, median strip or a vehicle parked on the farther carriageway boundary	80
22.	3.2(2)(d)	Parking closer than 1 metre from another vehicle	80
23.	3.2(2)(e)	Causing obstruction to another vehicle on a carriageway	100
24.	3.2(2)(f)	Parking a vehicle against the normal flow of traffic whilst on a carriageway	80
25.	3.2(3)(a)	Parking on a carriageway when prohibited at all times by a sign	80

Item No.	Clause No.	Nature of offence	Modified Penalty \$
26.	3.2(3)(b)	Parking on a carriageway when prohibited during a period by a sign	80
27.	3.2(4)(a)	Parking on or adjacent to a median strip	80
28.	3.2(4)(b)	Obstructs a private drive or carriageway or denies reasonable access to a private drive or right of way or carriageway	150
29.	3.2(4)(c)	Stopping beside excavation or obstruction so as to obstruct traffic	80
30.	3.2(4)(d)	Stopping within 10 metres of traffic island	80
31.	3.2(4)(e)	Stopping on pedestrian crossing	100
32.	3.2(4)(f)	Stopping a vehicle within 10 metres of departure side or 20 metres approach side of a children's or pedestrian crossing	100
33.	3.2(4)(g)	Stopping a vehicle within 20 metres of approach side or departure side of railway level crossing	80
34.	3.2(4)(h)	Stopping within 3 metres of continuous dividing line markings	80
35.	3.2(4)(i)	Stopping in a clearway	150
36.	3.2(5)(a)	Stopping on a carriageway when prohibited by a sign	80
37.	3.2(5)(b)	Stopping on a carriageway when prohibited during a period by a sign	80
38.	3.2(5)(c)	Stopping contrary to a 'no stopping' sign	100
39.	3.2(5)(d)	Stopping within continuous yellow line	100
40.	3.2(5)(e)	Stopping in an area set aside for vehicles of a different class	100
41.	3.2(5)(f)	Stopping in an area set aside for persons of a different class	100
42.	3.2(6)	Parked in a 'no parking' area	100
43.	3.3(1)(a)	Failure to park as near as practicable or parallel with the boundary	80
44.	3.3(1)(b)	Failure to park at approximate right angle	80
45.	3.4(2)	Failure to park at an appropriate angle	80
46.	3.4(3)	Vehicle not reversed in to a parking bay in accordance with signage	80
47.	3.5(1)(a)	Parking a heavy or long vehicle on a carriageway in excess of 1 hour when not actively engaged in loading or unloading	80

Item No.	Clause No.	Nature of offence	Modified Penalty \$
48.	3.5(1)(b)	Parking a heavy or long vehicle not on the shoulder of a carriageway or other specified area	80
49.	3.6	Parking contrary to directions of an Authorised Person	250
50.	3.7(2)	Removing a mark made by an Authorised Person	250
51.	3.9(a)	Parking in thoroughfare for purpose of sale	80
52.	3.9(b)	Parking unlicensed vehicle in thoroughfare	80
53.	3.9(c)	Parking a trailer or caravan on a thoroughfare unattached to a motor vehicle	80
54.	3.9(d)	Parking in thoroughfare in order to effect repairs	80
55.	3.10(2)	Parking on private land without consent	100
56.	3.10(3)	Parking on land not in accordance with consent	100
57.	3.10(4)	Displaying a Private Property Parking Enforcement Agreement sign without a current Private Property Parking Enforcement Agreement	250
58.	3.11	Driving or parking on a reserve	150
59.	3.12	Vehicle stopped or parked in a right of way causing an obstruction	150
60.	3.13(2)	Parking without authorisation	100
61.	4.1(1)	Parking on thoroughfare within 20 metres of a signaled intersection	100
62.	4.1(2)	Parking on thoroughfare within 10 metres of an intersection	100
63.	4.2(a)	Not engaged in loading or unloading whilst stopped in a loading zone	80
64.	4.2(b),(c)	Stopping in a loading zone in excess of maximum time allowed	80
65.	4.3	Stopping unlawfully in a taxi zone or bus zone	80
66.	4.4	Stopping unlawfully in a mail zone	80
67.	4.5(8)	Unauthorised stopping in a construction site work zone	100
68.	5.1	Stopping unlawfully in a shared zone	80
69.	5.2(1)	Double parking	100
70.	5.3	Stopping near an obstruction	80
71.	5.4(a)	Stopping in a bus lane	80
72.	5.4(b)	Stopping in a transit lane	80
73.	5.4(c)	Stopping in a truck lane	80
74.	5.4(d)	Stopping in a bicycle lane	80

Item No.	Clause No.	Nature of offence	Modified Penalty \$
75.	5.5(1)	Stopping on a bridge, causeway or ramp	100
76.	5.5(2)	Stopping in a tunnel or underpass	100
77.	5.6(1)	Stopping on a crest or curve	100
78.	5.7	Stopping within 1 metre of a fire hydrant or fire plug	100
79.	5.8(1)	Stopping near a bus stop	100
80.	5.9	Stopping on a traffic island	100
81.	5.10(1)(a)	Stopping on a verge without consent of adjacent owner or occupier	100
82.	5.10(1)(b)	Stopping a commercial vehicle, bus, trailer, boat, caravan or truck on a verge	100
83.	5.10(1)(c)	Stopping on a verge contrary to a sign	100
84.	5.11	Driving a vehicle across a footpath or verge adjacent to a length of carriageway	100
85.	5.12(1)	Causing an obstruction to a footpath or path	100
86.	5.12(2)	Stopped on or across a crossover to deny access to the adjacent premises or land	150
87.	5.12(3)	Stopped on or across a crossover obstructing a footpath	150
88.	5.13	Stopping within 3 metres of a public letter box	80
89.	5.14	Stopping in a bicycle parking area	80
90.	5.15	Stopping in a motorcycle parking area	80
91.	5.16	Stopping on a median strip	100
92.	5.17	Stopping in an eating area	100
93.	6.5(2)	Failure to display a valid Permit	80
94.	6.7	Use of a counterfeit or altered parking permit	250
95.	7.1	Impersonating an Authorised Person	250
96.	7.2	Removing a notice from a vehicle without authority	100
97.	7.3(a)	Unauthorised exhibition of a parking control sign	100
98.	7.3(b)	Misuse or deface a sign exhibited by the local government	100
99.	7.3(c)	Affix anything to a sign exhibited by the local government	100
100.	7.6(1)	Cause or attempting to cause damage to a parking area or associated infrastructure	500
101.	7.6(2)	Operating a ticket machine or pay station not in accordance with instructions	100

Item No.	Clause No.	Nature of offence	Modified Penalty \$
102.	7.8(1)	Leaving a vehicle so as to obstruct a public place	150
103.	-	All other offences not specified	100

Dated thisday of2019

The Common Seal of the)
 Shire of Northam was)
 affixed by authority of a)
 resolution of the Council)
 in the presence of)

.....
 CHRISTOPHER ANTONIO
 President

.....
 JASON WHITEAKER
 Chief Executive Officer



12.5 COMMUNITY SERVICES

Nil.

13. MATTERS BEHIND CLOSED DOORS

RECOMMENDATION / COUNCIL DECISION

Minute No: C.3790

Moved: Cr Ryan

Seconded: Cr Little

That Council, in accordance with section 11.1(i) of the Shire of Northam Standing Orders Local Law 2018 and Section 5.23 (2) (c) and (a) of the *Local Government Act 1995*, meet behind closed doors to consider agenda items:

- 13.1 – Purchase of A12173 as the item relates to a contract which may be entered into by the local government; and
- 13.2 – Shire of Northam Licensing Services as the item relates to employees.

CARRIED 6/0

The Gallery, Killara Manager and Manager Health and Environment left the meeting at 5:47pm.

13.1 PURCHASE OF A12173

RECOMMENDATION / COUNCIL DECISION

Minute No: C.3791

Moved: Cr Mencshelyi

Seconded: Cr Della

That Council

1. Approve an unbudgeted expenditure of \$14,000 from GL 19693200 Stormwater Drainage Reserve to purchase property 50 Throssell Street, Northam;
2. Authorise the Chief Executive Officer to sign the purchasing documents for settlement.

**CARRIED 6/0
BY ABSOLUTE MAJORITY**

Cr J E G Williams declared an "Impartiality" interest in item 13.2 – Shire of Northam Licensing Services as one of her non-dependent children is a Shire employee.

13.2 SHIRE OF NORTHAM LICENSING SERVICES

RECOMMENDATION / COUNCIL DECISION

Minute No: C.3792

Moved: Cr Mencshelyi

Seconded: Cr Della

That Council;

1. Authorise the CEO to continue discussions with Toodyay Community Bank regarding licensing services at the Northam Branch;
2. Authorise the CEO to commence discussions with the Department of Transport regarding the contract for Licencing; and
3. Request the CEO to report back to Council with a recommendation should an agreement be reached.

CARRIED 6/0

RECOMMENDATION / COUNCIL DECISION

Minute No: C.3793

Moved: Cr Ryan

Seconded: Cr Mencshelyi

That Council move out from behind closed doors.

CARRIED 6/0

The Gallery, Killara Manager and Manager Health and Environment returned to the meeting at 5:50pm.

14. MOTIONS OF WHICH PREVIOUS NOTICE HAS BEEN GIVEN

MOTION

Moved: Cr C R Antonio

That Council:

1. Request the construction of a raised disabled parking bay at the front of Centre Link to enable parking to suit the needs of their clients and other disabled people; and
2. Request the Chief Executive Officer to present detailed costings to Council which shall be incorporated into the 2020/21 Budget Consideration List.

The Chief Executive Officer sought clarification on the intent of the motion as it was unclear if the intent was to construct or present detailed costings. The motion was subsequently amended.

MOTION / COUNCIL DECISION

Minute No: C.3794

Moved: Cr C R Antonio

Seconded: Cr Mencshelyi

That Council request the Chief Executive Officer to present detailed costings to the 2020/21 Annual Budget consideration list for the construction of raised disabled parking bays at the eastern end of Fitzgerald Street, Northam in proximity of Centrelink in accordance with the Shire of Northam Town Centre Parking Strategy.

CARRIED 6/0

Clarification was sought in relation to:

- Whether Centrelink can be asked to provide a contribution. The Chief Executive Officer advised that they could be asked, however there is no requirement; and
- Whether it is appropriate to look at other side of the road? The Executive Manager Engineering Services advised that the Shire of Northam Town Centre Parking Strategy identifies a need for disabled bays on the eastern side of Fitzgerald Street. The Chief Executive Officer advised that this can be incorporated into the motion.

BACKGROUND

There is no disabled parking bays heading towards the traffic lights after the raised bay at the front of Westpac. As this end of town is in need of promotion, this amenity would encourage more people, particularly those with a disability to frequent that end of town.

OFFICERS COMMENT

The request for the disabled bay in this location aligns with the Shire Parking Strategy and is supported by staff. Staff recommend that the construction of this disabled bay be included in the 2020/21 Annual Budget presented to Council for adoption. This will allow staff sufficient time to design, as there will be verge, kerb and drainage modifications required to meet correct disabled bay standards. A detailed costing can then be calculated.

15. URGENT BUSINESS APPROVED BY DECISION

Nil.

16. DECLARATION OF CLOSURE

There being no further business, the Shire President, Cr C R Antonio declared the meeting closed at 5:58pm.

"I certify that the Minutes of the Ordinary Meeting of Council held on Wednesday, 16 October 2019 have been confirmed as a true and correct record."

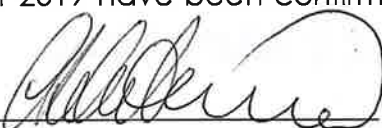

20/11/19

Date