



Shire of Northam
Heritage, Commerce and Lifestyle

Shire of Northam

Minutes

Ordinary Council Meeting

22 January 2020

UNCONFIRMED

DISCLAIMER

In certain circumstances members of the public are not entitled to inspect material, which in the opinion of the Chief Executive Officer is confidential, and relates to a meeting or a part of a meeting that is likely to be closed to members of the public.

No responsibility whatsoever is implied or accepted by the Shire of Northam for any act, omission, statement or intimation occurring during Council or Committee meetings.

The Shire of Northam disclaims any liability for any loss whatsoever and howsoever caused arising out of reliance by any person or legal entity on any such act, omission or statement of intimation occurring during Council or Committee meetings.

Any person or legal entity who acts or fails to act in reliance upon any statement, act or omission made in a Council or Committee meeting does so at that person's or legal entity's own risk.

In particular and without derogating in any way from the broad disclaimer above, in any discussion regarding any planning application or application for a licence, any statement or intimation of approval made by any member or Officer of the Shire of Northam during the course of any meeting is not intended to be and is not taken as notice of approval from the Shire of Northam.

The Shire of Northam advises that anyone who has any application lodged with the Shire of Northam must obtain and should only rely on WRITTEN CONFIRMATION of the outcome of the application and any conditions attaching to the decision made by the Shire of Northam in respect of the application.

The Shire of Northam advises that any plans or documents contained within this agenda may be subject to copyright law provisions (*Copyright Act 1968*, as amended) and that the express permission of the copyright owner(s) should be sought prior to their reproduction. It should be noted that copyright owners are entitled to take legal action against any persons who infringe their copyright. A reproduction of material that is protected by copyright may represent a copyright infringement.

Contents

1.	DECLARATION OF OPENING	5
2.	ATTENDANCE.....	5
2.1	APOLOGIES.....	5
2.2	APPROVED LEAVE OF ABSENCE	5
3.	DISCLOSURE OF INTERESTS.....	6
4.	ANNOUNCEMENT BY THE PRESIDING MEMBER (WITHOUT DISCUSSION)....	7
5.	PUBLIC QUESTION TIME	9
5.1	PUBLIC QUESTIONS.....	9
6.	RESPONSE TO PREVIOUS PUBLIC QUESTIONS TAKEN ON NOTICE	9
7.	RECEIVING OF PETITIONS, PRESENTATIONS AND DEPUTATIONS	9
7.1	PETITIONS.....	9
7.2	PRESENTATIONS	9
7.3	DEPUTATIONS.....	9
8.	APPLICATION FOR LEAVE OF ABSENCE.....	9
9.	CONFIRMATION OF MINUTES	10
9.1	ORDINARY COUNCIL MEETING HELD 18 DECEMBER 2019	10
9.2	NOTES FROM THE COUNCIL FORUM MEETING HELD 20 JANUARY 2020	10
10.	ITEMS BROUGHT FORWARD FOR THE CONVENIENCE OF THOSE IN THE PUBLIC GALLERY	31
11.	REPORTS OF COMMITTEE MEETINGS	31
12.	OFFICER REPORTS	31
12.1	CEO'S Office	31
12.2	ENGINEERING SERVICES.....	31
12.2.1	Shire of Northam W5.6 Verges Policy Review	31
12.2.2	Replacement Vehicle for Works Manager – Northam Operations Depot	60
12.3	DEVELOPMENT SERVICES	65
12.3.1	Proposed Road Dedication – Great Eastern Highway, Coates Gully	65
12.3.2	Environmental Protection Act 1986 Review – Consideration of WALGA'S submission	77
12.3.3	Environmental Protection and Biodiversity Conservation Act 1999 Review – Consideration of WALGA'S submission.....	133

12.3.4	WALGA'S Third Party Appeal Rights – Preferred Model	181
12.3.5	Request for Quotation for Waste Collection Services in the Shire of Northam and Avon Regional Organisation of Councils	193
12.3.6	Corella Management	199
12.4	CORPORATE SERVICES	209
12.4.1	Accounts & Statements of Accounts – December 2019 ..	209
12.4.2	Financial Statement for the period ending 31 December 2019	286
12.5	COMMUNITY SERVICES	305
12.5.1	Donation of Dulcie Armstrong Paintings to the Shire of Northam Art Collection	305
12.5.2	Gordon Place Art - Mural.....	311
12.5.3	Short Stay Caravan Facilities Feasibility	326
12.5.4	Community Representation on Council Committees	375
13.	MATTERS BEHIND CLOSED DOORS	385
13.1	CONFIDENTIAL SHIRE OF NORTHAM LICENSING SERVICES	385
14.	MOTIONS OF WHICH PREVIOUS NOTICE HAS BEEN GIVEN.....	386
15.	URGENT BUSINESS APPROVED BY DECISION	386
16.	DECLARATION OF CLOSURE	386

1. DECLARATION OF OPENING

The Shire President, Cr C R Antonio declared the meeting open at 5:30pm.

2. ATTENDANCE

Council:

Shire President
Deputy Shire President
Councillors

C R Antonio
J E G Williams
M I Girak
A J Mencshelyi
D Galloway
C P Della
T M Little
R W Tinetti
M P Ryan
S B Pollard

Staff:

Acting Chief Executive Officer / Executive
Manager Engineering Services
Executive Manager Development Services
Executive Manager Community Services
Executive Assistant – CEO
Coordinator Governance / Administration
Accountant
Manager Health & Environment

C D Kleynhans
C B Hunt
R Rayson
A C McCall
C F Greenough
Z Macdonald
C E Sadleir

Gallery:

Avon Valley Advocate
Public

Eliza Wynn
Heather Meiklem
Marie Edmonds at 5:34pm

2.1 APOLOGIES

Chief Executive Officer
Executive Manager Corporate Services

J B Whiteaker
C Young

2.2 APPROVED LEAVE OF ABSENCE

Nil.

3. DISCLOSURE OF INTERESTS

Item Name	Item No.	Name	Type of Interest	Nature of Interest
Request for Quotation for Waste Collection Services in the Shire of Northam and Avon Regional Organisation of Councils	12.3.5	Mr C B Hunt	Impartiality	The Directors/owners of Avon Waste are known to him. He was not involved in the assessment process or recommendation report.
Gordon Place Art – Mural	12.5.2	Cr R W Tinetti	Proximity	The wall on his place of business has been included as a possible location for an art mural.
		Cr M I Girak	Impartiality	She knows the owners of the building on Gordon Place. The extent of her interest is minor and it will not affect her decision.
Community Representation on Council Committees	12.5.4	Cr S B Pollard	Impartiality	A number of applicants are known to him.
		Cr C R Antonio	Impartiality	A number of nominees are known to him.
Confidential Shire of Northam Licensing Services	13.1	Cr J E G Williams	Impartiality	One of her non dependent children holds one of the staff positions affected by this decision.
		Cr M I Girak	Impartiality	She knows the Senior Licensing Officer and some of the customer service staff that may be affected. The extent of her interest is minimal and it will not affect her decision.

4. ANNOUNCEMENT BY THE PRESIDING MEMBER (WITHOUT DISCUSSION)

Visitations and Consultations	
19/12/2019	Avonvale Education Support Centre end of year awards
20/12/2019	Northam Post Office Official Draw of Raffle
20/12/2019	Avon Valley Youth Services Christmas Function
20/12/2019	STRYKA Fight Team Awards Night
21/12/2019	Southern Brook Christmas Party
25/12/2019	Christmas Day
26/12/2019	Boxing Day
31/12/2019	New Year's Eve
01/01/2020	New Year's Day
08/01/2020	Meeting re: 2021 World Women's Ballooning Championship
10/01/2020	Advocate interview at Northam Aquatic Facility
13/01/2020	MMM Fortnightly Radio Interview
14/01/2020	Forget me not café event - Northam
17/01/2020	Community BBQ Fundraiser Northam for Bushfire Victims
20/01/2020	MMM Fortnightly Radio Interview
22/01/2020	Annual Meeting of Electors - Northam
Upcoming Events	
25/01/2020	Official Opening – Northam Aquatic Facility
26/01/2020	Australia Day Breakfast – Southern Brook
26/01/2020	Citizenship Ceremony - Northam
26/01/2020	Community Australia Day Awards - Northam
26/01/2020	Australia Day Ceremony and Concert - Northam
01/02/2020	Lions Community Markets
03/02/2020	MMM Fortnightly Radio Interview
06/02/2020	Northam Chamber of Commerce Business After Hours
08/02/2020	Northam Bushfire Appeal Variety Night
11/02/2020	Forget me not café event Northam
13/02/2020	Regional Capitals Alliance Meeting - Perth
17/02/2020	AROC Meeting - Toodyay
19/02/2020	Wheatbelt District Emergency Management Meeting

Operational Matters:

New Year and events

Happy New Year. As we move into 2020, which, depending on your thoughts, is the start of a new Decade. There are many Shire and Community activities scheduled for the year ahead. The community are holding fundraisers over January and February for those affected by the Bushfires. Researching the Shire website, there are a number of events over the next couple of months. There is always something happening within the Shire of Northam.

Meeting Dates and Locations for 2020 confirmed

At a 2019 Council Meeting, dates and locations for the Forum and Ordinary Council Meetings determined. Once again, these meetings will be held over various locations in the Shire. The January meeting is set for Northam and February for Bakers Hill.

Prohibited Burning Period and Volunteering

As we remain in the Prohibited Burning Period, no burning is permitted within the Shire of Northam. For all people, please ensure that you are bushfire ready. With the devastating Bushfires currently being experienced across much of Australia, think about how you can help. This might be by becoming a bushfire, or other, volunteer.

Strategic Matters:

The Northam Aquatic Facility official opening is confirmed for the 25th January 2020. The people behind this project all deserve a very large vote of thanks. Some of the people and groups involved with this are: Council who made the decision for this project, the funding bodies to allow the project to go ahead, the groups involved with the planning and construction, the community who have provided feedback into the design, and importantly, the staff who researched, recommended and supervised the construction project. This major project will be a valuable Shire of Northam Project.

5. PUBLIC QUESTION TIME

5.1 PUBLIC QUESTIONS

Nil.

6. RESPONSE TO PREVIOUS PUBLIC QUESTIONS TAKEN ON NOTICE

Nil.

7. RECEIVING OF PETITIONS, PRESENTATIONS AND DEPUTATIONS

7.1 PETITIONS

Nil.

7.2 PRESENTATIONS

The Shire President presented a certificate of appreciation to the Shire of Northam which was received from STRYKA Fight Team for contributing towards purchasing combat sports training equipment and other critical resources required for their team to function effectively.

7.3 DEPUTATIONS

Nil.

8. APPLICATION FOR LEAVE OF ABSENCE

RECOMMENDATION / COUNCIL DECISION

Minute No: C.3852

Moved: Cr Mencshelyi

Seconded: Cr Girak

That Council grant Cr J E G Williams leave of absence from 21 February 2020 to 3 March 2020 (inclusive).

CARRIED 10/0

One (1) member of the Gallery entered the meeting at 5:34pm.

9. CONFIRMATION OF MINUTES

9.1 ORDINARY COUNCIL MEETING HELD 18 DECEMBER 2019

RECOMMENDATION / COUNCIL DECISION

Minute No: C.3853

Moved: Cr Ryan

Seconded: Cr Girak

That the minutes of the Ordinary Council meeting held on Wednesday, 18 December 2019 be confirmed as a true and correct record of that meeting, subject to the following amendment:

- Removal of item 2 within decision C.3848.

CARRIED 10/0

9.2 NOTES FROM THE COUNCIL FORUM MEETING HELD 20 JANUARY 2020

RECOMMENDATION / COUNCIL DECISION

Minute No: C.3854

Moved: Cr Pollard

Seconded: Cr Della

That Council receive the notes from the Council Forum meeting held Monday, 20 January 2020.

CARRIED 10/0

Attachment 1



Shire of Northam
Heritage, Commerce and Lifestyle

Shire of Northam

Notes

Council Forum Meeting

20 January 2020

DISCLAIMER

This agenda has yet to be dealt with by the Council. The Recommendations shown at the foot of each item have yet to be considered by the Council and are not to be interpreted as being the position of the Council. The minutes of the meeting held to discuss this agenda should be read to ascertain the decision of the Council.

In certain circumstances members of the public are not entitled to inspect material, which in the opinion of the Chief Executive Officer is confidential, and relates to a meeting or a part of a meeting that is likely to be closed to members of the public.

No responsibility whatsoever is implied or accepted by the Shire of Northam for any act, omission, statement or intimation occurring during Council or Committee meetings.

The Shire of Northam disclaims any liability for any loss whatsoever and howsoever caused arising out of reliance by any person or legal entity on any such act, omission or statement of intimation occurring during Council or Committee meetings.

Any person or legal entity who acts or fails to act in reliance upon any statement, act or omission made in a Council or Committee meeting does so at that person's or legal entity's own risk.

In particular and without derogating in any way from the broad disclaimer above, in any discussion regarding any planning application or application for a licence, any statement or intimation of approval made by any member or Officer of the Shire of Northam during the course of any meeting is not intended to be and is not taken as notice of approval from the Shire of Northam.

The Shire of Northam advises that anyone who has any application lodged with the Shire of Northam must obtain and should only rely on WRITTEN CONFIRMATION of the outcome of the application and any conditions attaching to the decision made by the Shire of Northam in respect of the application.

The Shire of Northam advises that any plans or documents contained within this agenda may be subject to copyright law provisions (*Copyright Act 1968*, as amended) and that the express permission of the copyright owner(s) should be sought prior to their reproduction. It should be noted that copyright owners are entitled to take legal action against any persons who infringe their copyright. A reproduction of material that is protected by copyright may represent a copyright infringement.

Council Forum Meeting Notes
20 January 2020



Preface

When the Chief Executive Officer approves these Notes for distribution they are in essence "informal notes."

At the next Ordinary Meeting of Council the Notes will be received, subject to any amendments made by the Council. The "Received" Notes are then signed off by the Presiding Person.

Please refer to the Ordinary Council meeting agenda and minutes for further information and details in relation to the matters and items discussed at the Forum meeting.

Unconfirmed Notes

These notes were approved for distribution on 21 January 2020.



CLINTON KLEYNHANS
ACTING CHIEF EXECUTIVE OFFICER

Received Notes

These notes were received at an Ordinary Meeting of Council held on 18 December 2019.

Signed:

Note: The Presiding Member at the meeting at which the minutes were confirmed is the person who signs above.

Contents

1.	DECLARATION OF OPENING.....	6
2.	ATTENDANCE.....	6
2.1	APOLOGIES.....	6
2.2	APPROVED LEAVE OF ABSENCE	6
3.	DISCLOSURE OF INTERESTS.....	7
4.	ANNOUNCEMENT BY THE PRESIDING MEMBER (WITHOUT DISCUSSION)	7
5.	PUBLIC QUESTION TIME	7
5.1	PUBLIC QUESTIONS.....	7
6.	RESPONSE TO PREVIOUS PUBLIC QUESTIONS TAKEN ON NOTICE	8
7.	RECEIVING OF PETITIONS, PRESENTATIONS AND DEPUTATIONS	8
7.1	PETITIONS.....	8
7.2	PRESENTATIONS	8
7.3	DEPUTATIONS.....	8
8.	APPLICATION FOR LEAVE OF ABSENCE.....	8
9.	CONFIRMATION OF MINUTES	8
9.1	ORDINARY COUNCIL MEETING HELD 18 DECEMBER 2019	8
9.2	NOTES FROM THE COUNCIL FORUM MEETING HELD 20 JANUARY 2020	8
10.	ITEMS BROUGHT FORWARD FOR THE CONVENIENCE OF THOSE IN THE PUBLIC GALLERY	8
11.	REPORTS OF COMMITTEE MEETINGS	9
12.	OFFICER REPORTS	9
12.1	CEO'S Office	9
12.2	ENGINEERING SERVICES.....	9
12.2.1	Shire of Northam W5.6 Verges Policy Review	9
12.2.2	Replacement Vehicle for Works Manager – Northam Operations Depot	12
12.3	DEVELOPMENT SERVICES	12
12.3.1	Proposed Road Dedication – Great Eastern Highway, Coates Gully	12
12.3.2	Environmental Protection Act 1986 Review – Consideration of WALGA'S submission	13

Council Forum Meeting Notes
20 January 2020

12.3.3	Environmental Protection and Biodiversity Conservation Act 1999 Review – Consideration of WALGA'S submission.....	13
12.3.4	Proposed Variation to Building Envelope, Construction of a Dwelling and Shed at Lot 422 Gumtree Road, Bakers Hill ..	13
12.3.5	WALGA'S Third Party Appeal Rights – Preferred Model	13
12.3.6	Request for Quotation for Waste Collection Services in the Shire of Northam and Avon Regional Organisation of Councils	14
12.3.7	Corella Management	14
12.4	CORPORATE SERVICES	15
12.4.1	Accounts & Statements of Accounts – December 2019	15
12.4.2	Financial Statement for the period ending 31 December 2019	17
12.5	COMMUNITY SERVICES	17
12.5.1	Donation of Dulcie Armstrong Paintings to the Shire of Northam Art Collection	17
12.5.2	Gordon Place Art – Mural	18
12.5.3	Short Stay Caravan Facilities Feasibility	19
12.5.4	Community Representation on Council Committees	19
13.	MATTERS BEHIND CLOSED DOORS	19
13.1	CONFIDENTIAL SHIRE OF NORTHAM LICENSING SERVICES	20
14.	MOTIONS OF WHICH PREVIOUS NOTICE HAS BEEN GIVEN	20
15.	URGENT BUSINESS APPROVED BY DECISION	20
16.	DECLARATION OF CLOSURE	20

Council Forum Meeting Notes
20 January 2020

1. DECLARATION OF OPENING

The Shire President, Cr C R Antonio declared the meeting open at 5:30pm.

2. ATTENDANCE

Council:

Shire President
Deputy Shire President
Councillors

C R Antonio
J E G Williams
M I Girak
A J Mencshelyi
D Galloway
C P Della
T M Little
R W Tinetti
M P Ryan
S B Pollard

Staff:

Acting Chief Executive Officer / Executive
Manager Engineering Services
Executive Manager Development Services
Executive Manager Community Services
Executive Assistant – CEO
Coordinator Governance / Administration
Accountant
Manager Health & Environment

C D Kleynhans
C B Hunt
R Rayson
A C McCall
C F Greenough
Z Macdonald
C E Sadleir

Gallery:

Avon Valley Advocate
Public

Eliza Wynn
Heather Meiklem
Don Hadrill

2.1 APOLOGIES

Chief Executive Officer
Executive Manager Corporate Services

J B Whiteaker
C Young

2.2 APPROVED LEAVE OF ABSENCE

Nil.

3. DISCLOSURE OF INTERESTS

Item Name	Item No.	Name	Type of Interest	Nature of Interest
Gordon Place Art – Mural	12.5.2	Cr R W Tinetti	Proximity	The wall on his place of business has been included as a possible location for an art mural.
		Cr M I Girak	Impartiality	She knows the owners of the building on Gordon Place. The extent of her interest is minor and it will not affect her decision.
Confidential Shire of Northam Licensing Services	13.1	Cr J E G Williams	Impartiality	One of her non dependent children holds one of the staff positions affected by this decision.
		Cr M I Girak	Impartiality	She knows the Senior Licensing Officer and some of the customer service staff that may be affected. The extent of her interest is minimal and it will not affect her decision.

4. ANNOUNCEMENT BY THE PRESIDING MEMBER (WITHOUT DISCUSSION)

No queries were raised in relation to this item.

5. PUBLIC QUESTION TIME

5.1 PUBLIC QUESTIONS

Name: Don Hadrill, Northam.

Question: What is Council doing in regards to the condition of Hadrill Road?

Mr Hadrill advised that he has lived in the Town and Shire his entire life and advised that the road is in an appalling state. He has concerns for the school buses that use this road and it has been the school bus route for approximately 100 years. He advised that the road is very narrow, it was previously 1.5 cars in width however due to the chipping of the edge it has decreased to only fitting one car on the road. He outlined that the traffic

has increased on this road, with people not driving to the conditions. There has been some cosmetic works completed recently however it is not sufficient to address the safety issues on the road.

Response: The Acting Chief Executive Officer advised that some remedial works have been completed recently and there will be grading completed in the next few months. In addition, there are sections of the road within the 2020/21 program for road widening. The road will also be presented to Council on the consideration list following this request. It was advised the consideration list of roads is not based on condition rating of the road, therefore has lower priority to the current endorsed program.

6. RESPONSE TO PREVIOUS PUBLIC QUESTIONS TAKEN ON NOTICE

Nil.

7. RECEIVING OF PETITIONS, PRESENTATIONS AND DEPUTATIONS

7.1 PETITIONS

Nil.

7.2 PRESENTATIONS

No queries were raised in relation to this item.

7.3 DEPUTATIONS

Nil.

8. APPLICATION FOR LEAVE OF ABSENCE

No queries were raised in relation to this item.

9. CONFIRMATION OF MINUTES

9.1 ORDINARY COUNCIL MEETING HELD 18 DECEMBER 2019

No queries were raised in relation to this item.

9.2 NOTES FROM THE COUNCIL FORUM MEETING HELD 20 JANUARY 2020

No queries were raised in relation to this item.

10. ITEMS BROUGHT FORWARD FOR THE CONVENIENCE OF THOSE IN THE PUBLIC GALLERY

Nil.

11. REPORTS OF COMMITTEE MEETINGS

Nil.

12. OFFICER REPORTS

12.1 CEO'S Office

Nil.

12.2 ENGINEERING SERVICES

12.2.1 Shire of Northam W5.6 Verges Policy Review

Clarification was sought in relation to:

- Whether the word 'encourage' is strong enough in relation to residents maintaining their verges, i.e. would 'require' or 'expect' be more suitable? The Acting CEO advised that the legislation is very clear in outlining that it is the local government's responsibility to maintain. Officers have reviewed other local government's policies and the word 'encourage' appears to be the most appropriate given it is the local government's responsibility to maintain the verge. The policy outlines that Council will do as much as it can with the available resources however anything more than the commitment within the policy would require looking at budget allocations or the landowner doing their part.
- Whether the section relating to the stormwater being required to be kept on owner's property is relevant to this policy? The question was taken on notice by the Acting CEO.

Response Provided by Acting CEO

The statement relates to a hardstand area which is a permissible treatment, in some cases hardstand treatments cause an increase in stormwater runoff onto the road. This provision in the policy allows the Shire to provide direction on a case by case basis when assessing a verge development request. This has been slightly reworded as it is not always possible to contain stormwater from a verge. This has been replaced with "effectively managed."

- The section relating to tethering of boats was removed and then reinstated, what is the reasoning for this? The Acting CEO advised that this is believed to be a result of formatting in tracked changes when something is moved from one section and inserted in another it shows it as a deletion and an insertion.
- Whether the tree on the verge is the Shire's responsibility to maintain. The Acting CEO confirmed that this is the Shire's responsibility.

Additional Comment by Acting CEO

Further to this, an approved verge development is the responsibility of the adjacent landowner to maintain.

- Whether they need to advise if they do or do not wish for their verge to be sprayed (i.e. everyone must contact the Shire). The Acting CEO advised that the verge will be sprayed unless advised otherwise. Officers will review the wording in the policy to ensure this is clear.

Response by Acting CEO

Amended to: *The resident is to inform the Shire in writing if they wish their verge not to be sprayed by having it placed on the "No Spray Register".*

- Whether verge treatments pre-existing to this policy are required to be removed, an example was provided of a verge in Gairdner Street with lawn and palm trees. The question was taken on notice by the Acting CEO.

Response by Acting CEO

The following local law allows pre-existing verge treatment criteria:

ACTIVITIES IN THOROUGHFARES AND PUBLIC PLACES AND TRADING -
LOCAL LAW 2018 (& IN EFFECT FROM 2008)

Subdivision 3 - Existing verge treatments

2.12 Transitional provision

(1) In this clause –

"former provisions" means the local law of the local government which permitted certain types of verge treatments, whether with or without the consent of the local government, and which was repealed by this local law.

(2) A verge treatment which –

- (a) was installed prior to the commencement day; and
- (b) on the commencement day is a type of verge treatment which was permitted under and complied with the former provisions, is to be taken to be a permissible verge treatment for so long as the verge treatment remains of the same type and continues to comply with the former provisions.

With the Policy originally being adopted 19/9/12, the verge treatment at the mentioned location on Gairdner Street must have been developed prior to this date, and not deemed a safety risk warranting removal as per the provision of the adopted Policy at the time (19/9/12).

Council Forum Meeting Notes
20 January 2020

- Whether there needs to be an overlap with the Street Tree Policy. The Acting CEO advised that the Street Tree Policy is currently under review. Officers will review the wording and clarify whether there needs to be an overlap of the policies.

Response by Acting CEO

This criteria is not addressed in the existing Street Tree Policy, however better suited to be included. This has been removed and will be addressed in the Street Tree Policy.

- The reason for the removal of the words 'at least' with respect to the service level. The question was taken on notice by the Acting CEO.

Response by Acting CEO

Policy has been amended to include 'at least'.

- What was the rationale for removing the section relating to vegetable gardens? The Acting CEO advised that there are none in the Shire and no requests have been received. Officers therefore believe there is no need for this within the policy. Cr Pollard advised that the historic reason for including this was to encourage the use of the verge however it is acknowledged that this creates a range of hazards.
- Whether bus stops in rural areas will have the grass slashed. The Acting CEO advised that the verge compliance criteria requires a 1.5m clearance around the bus stop.
- Whether the policy applies to rural verges, i.e. is the landowner encouraged to maintain and how does this impact liability. The Acting CEO advised that we do not object to a rural landowner maintaining their verges however it is not something that is actively encouraged as there may be a need for traffic control.

Additional Comment by Acting CEO

Statement amended to: Property owners throughout the Shire are encouraged to maintain and/or improve the verge area outside their property, in a manner that ensures the safety of themselves and / or pedestrians and road users.

- In relation to the verge compliance criteria, is this for all bus stops? The Acting CEO advised that it is for all designated bus stops which can be viewed on the Public Transport Authority's (PTA) website. Where there is a designated bus stop it is the Shire responsibility to maintain. Bus stops can become designated through a request to the PTA and the Shire will provide comments (i.e. whether it is supported).

Additional Comment by Acting CEO

1.5m clearance relates to any new development application. Ongoing maintenance added to Shire's service levels.

12.2.2 Replacement Vehicle for Works Manager – Northam Operations Depot

Clarification was sought in relation to:

- Whether it is possible for the insurance company to provide the funds rather than the Shire being reimbursed? The Acting CEO advised that the insurer has agreed to a full payout. Cr Pollard advised that the item is presented to Council as it is not an authorised replacement within Council's program.

12.3 DEVELOPMENT SERVICES

12.3.1 Proposed Road Dedication – Great Eastern Highway, Coates Gully

Clarification was sought in relation to:

- The LED sign and the development application to move the sign, is the development application for a single sided sign? The Executive Manager Development Services advised that it is single sided and is relocating the existing sign.
- Where is the proposed location for the LED sign? The Executive Manager Development Services advised that Officers will clarify the exact location however it is not a substantial distance from the existing location. It was further queried whether this contradicts the previous Main Roads WA (MRWA) advice. The question was taken on notice by The Executive Manager Development Services.

Response by Manager Planning Services

A development application has been received to relocate the sign 90 metres east of its current position to a location on the site that is not affected by the proposed roadworks. MRWA have raised no objections in regards to this proposal, which is the subject of a development application currently being assessed and will be presented to the February Ordinary Council meeting for determination. The previous MRWA advice relates to the many applications submitted to extend the time of the existing development approval for the sign in its current approval location, which was time limited to 3 years and expires in September 2020.

The information regarding the sign in the current agenda item is for Council's information and does not affect the road closure proposal currently under consideration.

Council Forum Meeting Notes
20 January 2020



- Is the development application to move the sign relative to this item? The Executive Manager Development Services advised that this item has raised the sign relocation.
- Whether this is for widening or shifting. The Acting CEO advised that this is for widening however Officers have not received the final design.

12.3.2 Environmental Protection Act 1986 Review – Consideration of WALGA'S submission

Clarification was sought in relation to:

- Whether the changes and Shire's experience from interactions with the state government are adequately addressed in WALGA's submission? The Executive Manager Development Services advised that the Shire will generally deal with the Department of Water and Environmental Regulation (DWER). Officers have had some frustrations dealing with DWER for matters associated with illegal clearing, road widening and licensing of tip facilities. The Acting CEO advised that in some cases it is very direct e.g. covering clearing permits for road widening which is potentially more direct than Officers would like, however it is now a very structured process with costs being increased. The Executive Manager Development Services advised that overall, Officers are comfortable with the submission.

12.3.3 Environmental Protection and Biodiversity Conservation Act 1999 Review – Consideration of WALGA'S submission

- Whether Officer are comfortable with the WALGA submission? The Executive Manager Development Services advised that Officers are comfortable.
- The paper posed a number of questions which are not answered directly, is this correct. The question was taken on notice by The Executive Manager Development Services.

Response by Manager Health and Environment:

The second discussion/review paper by Professor Graeme Samuel raises questions throughout the paper which are not necessarily directly answered but raised as a precursor to the discussion paragraphs below the question/s.

12.3.4 Proposed Variation to Building Envelope, Construction of a Dwelling and Shed at Lot 422 Gumtree Road, Bakers Hill

Agenda item was withdrawn.

12.3.5 WALGA'S Thrd Party Appeal Rights – Preferred Model

Council Forum Meeting Notes
20 January 2020

Clarification was sought in relation to:

- How likely it is to pass? The Executive Manager Development Services advised that in the past there has been resistance from the government. This process is common in NSW and Victoria however Officers do not believe WA will go to a full third party appeal system. Officers believe that Council being able to appeal decisions is a good outcome.
- Whether the voting was close when considered at the WALGA AGM? The Shire President advised that it isn't believed to be close however will clarify.

Response

The WALGA AGM 2019 minutes do not record the carried amount:

3.9 Third Party Appeal Rights	
MOTION	
Moved	Cr Giorgia Johnson, City of Bayswater
Seconded	Cr Julie Mathison, City of Subiaco
1. That there be an amendment to the Third Party Appeals Process Preferred Model, being that third parties in addition to Local Governments are able to make an appeal.	
2. That there be an amendment to the Third Party Appeals Process Preferred Model, being that closely associated third parties in addition to Local Governments are able to appeal decisions made by the Western Australian Planning Commission and the State Administrative Tribunal, in addition to Development Assessment Panels.	
CARRIED	

IN BRIEF

- Further amendments proposed to the Preferred Model for Third Party Appeals Process

12.3.6 Request for Quotation for Waste Collection Services in the Shire of Northam and Avon Regional Organisation of Councils

Clarification was sought in relation to:

- Whether the contract includes the red skip bins. The Manager Health and Environment confirmed that this includes the skip bins.
- Whether there has been a large uptake of the skip bins in the broader Shire. The Manager Health and Environment confirmed that Council only pays for what it uses and bins can be reallocated between localities based on demand. Cr Little advised that there has been a strong uptake in Wundowie.
- Whether the service covers most of the Shire. The Manager Health and Environment advised that approximately 90% of households are on the service. A number routes were identified recently which are discussed in the report. The properties not serviced are large rural properties where there are not many properties on the road. If the truck goes past a property, it is compulsory to be on the service. The Manager Health and Environment outlined that there are some properties in the eastern and western areas of the Shire that are not on the service.

12.3.7 Corella Management

Clarification was sought in relation to:

Council Forum Meeting Notes
20 January 2020

- What the barrier is in relation to a coordinated approach with surrounding Council's? The Executive Manager Development Services advised that each Council is undertaking their own management techniques and no one has taken on the coordination role. The matter was discussed at an AROC meeting, with York and Tammin agreeing to be involved and other Councils indicating that they are interested. It is believed that Goomalling will coordinate the collaborative approach which will include a number of techniques such as scaring, destroying etc. The Executive Manager Development Services advised that it may be more cost effective to get a contractor to implement management techniques for all of the Shire's.
- Discussion was held around getting the shooting club to cull. The Executive Manager Development Services advised that some Shires have undertaken this approach as a permit is only required to trap and destroy. If this approach is taken, the contractor has identified the Northam Golf Course as a suitable location.
- Whether the state government has acknowledged that this is more than a local issue and whether this should be administered by them? The Executive Manager Development Services advised that this has not yet occurred and could take a number of years.
- Discussion was held around supplying farmers with shells to cull given many already have firearms. The Executive Manager Development Services advised that this was not something that has been considered from a logistical point of view, however is something that AROC can discuss.

12.4 CORPORATE SERVICES

12.4.1 Accounts & Statements of Accounts – December 2019

Reference	Date	Amount	Details Reference	Question	Query By	Answer
EFT35017	6/12/2019	119.00	BALLANTYNES JEWELLERS	Who is paying for the gifts? Is this common practice at the Shire for all leaving employees?	Cr Girak	Council Policy determines formal recognition for Local Government employees when they leave C.2440 20.05.2015.
EFT35120	6/12/2019	748.00	SOLAR LIGHTING DESIGN	Where will the lights be installed?	Cr Girak	This was two solar lights installed at the Purdowe Park.
EFT35124	6/12/2019	2794.00	STEPHEN CARRICK ARCHITECTS	Is this for a plan only? Will this be a place/room in the Shire Building for hard copy records?	Cr Girak	This was for development of Place record forms for private properties to be placed on the Heritage List, which will be presented to the February OCM.

Council Forum Meeting Notes
20 January 2020

Reference	Date	Amount	Details Reference	Question	Query By	Answer
EFT35192	12/12/2019	4072.05	MHW INTEGRATION PTY LTD	What is NAEIC Project Retention Claim 2?	Cr Girak	All major construction contracts have a retention to cover a 12 month defects period, after which the money is paid to the Contractor following a review and sign off by the Shire.
EFT35201	12/12/2019	298.20	PUBLIC TRANSPORT AUTHORITY	Train ticket for whom and for what reason?	Cr Girak	The Visitors Centre take bookings for the train service. This is then paid to the Public Transport Authority less a commission.
EFT35233	17/12/2019	22322.87	CORE BUSINESS AUSTRALIA	Which roads and what damage, or where to find the reference please?	Cr Girak	This contract covers roads damaged due to storms in 2017 and 2018. It is paid for through the WANDRRA grant received. Works are primarily in the Bakers Hill area, full details can be found in Council Meeting Minutes May 2019.
EFT35249	17/12/2019	300.00	TRAVEL SUBSIDY FOR FLOORBALL	What program/budget item this is funded from?	Cr Girak	This came from Community Sponsorship and is covered under Policy C 2.1- Community Grants Scheme.
EFT35281	20/12/2019	1195.00	ANGIE ROE PHOTOGRAPHY	Could it not be photographed by Michelle Blackhurst?	Cr Girak	Michelle is employed as Community Development Officer. This not part of her role.
EFT35312	20/12/2019	850.00	NAVIGATOR PHOTOGRAPHIX	Could it not be photographed by Michelle Blackhurst?	Cr Girak	Most of these photos were undertaken by drone photography for which you need a licenced operator.
EFT35326	20/12/2019	2764.65	COLES PURCHASES FOR STAFF	Why so high? Was this purchase for a staff function?	Cr Girak	This includes catering supplies for clients at the Aged Care facility.
EFT35327	20/12/2019	462.70	BOX OF 10 NOUGAT 15 IN A BOX	Are they Christmas gifts?	Cr Girak	Merchandise for the Visitors Centre.
EFT35332	20/12/2019	274.00	THE PRINT SHOP BUNBURY	What is it for and why not locally sourced?	Cr Girak	This is a local purchase but is invoiced from the Bunbury Shop but supplied from the Wheatbelt Print Shop.

Council Forum Meeting Notes
20 January 2020

Reference	Date	Amount	Details Reference	Question	Query By	Answer
Card		95.78	Executive Manager Corporate Services - FOREIGN TRANSACTION FEE	Why is the foreign transaction fee so high? Is it for the purchase of three software licences totalling \$544.18?	Cr Girak	These are foreign transaction fees on Facebook and Adobe transactions held overseas for the billing period.
Inv 20010005	06/12/2019	426.90	Northam Beta Bectical	Processor and blender, was this for Killara	Cr Williams	Yes it was for Killara.
Inv CK05122	06/12/2019	200.00	Northam Courthouse	Extra ordinary licence application, is this being reimbursed to the Shire by the applicant	Cr Williams	This will be reimbursed by the applicant.

12.4.2 Financial Statement for the period ending 31 December 2019

Details Reference	Question	Query By	Answer
Note 5	Just wanted to confirm that this should read OVER budget, Not under?	Cr Antonio	Sorry Chris yes it should be over budget.
Net Current Assets Year to Date	Why big difference in budget YTD vs actual YTD?	Cr Antonio	Net current assets year to date includes cash, rates receivable and accrued income- grants for the pool, which we anticipate will be expended at the end of the financial year. The budget position is at the end of the financial year not year to date.
Loan 228 - Swimming Pool	What should figure be in column 19/20 Budget Principal repayments?	Cr Antonio	We had budgeted to take the loan at the latter end of the financial year, hence the first repayment would have been incurred the following financial year not the 19/20 year.

12.5 COMMUNITY SERVICES

12.5.1 Donation of Dulcie Armstrong Paintings to the Shire of Northam Art Collection

Clarification was sought in relation to:

- The recent process undertaken for disposing the artwork, what makes these items special compared to others which were disposed of. The Executive Manager Community Services advised that the items which were previously disposed were under a certain value. Council has other artwork by this artist who is well known. The value of the artwork is unknown as a valuation has not been undertaken however the existing art by this artist was above the threshold for disposal.
- Does dispose refer to taking the item to the tip? The Executive Manager Community Services advised that Officers went through a process of advertising the artwork for people who may be interested in acquiring.

Council Forum Meeting Notes
20 January 2020



Cr R W Tinetti declared a "Proximity" interest in item 12.5.2 - Gordon Place Art – Mural as the wall on his place of business has been included as a possible location for an art mural.

Cr M I Girak declared an "Impartiality" interest in item 12.5.2 - Gordon Place Art – Mural as she knows the owners of the building on Gordon Place. The extent of her interest is minor and it will not affect her decision.

Cr Tinetti left the meeting at 6:28pm.

12.5.2 Gordon Place Art – Mural

Clarification was sought in relation to:

- The reference to the final selection being made by Council staff. The Executive Manager Community Services advised that this was due to the disbanded Art Advisory Committee and Officers believed this was the easiest approach. However, it is up to Council if they wish to be involved, e.g. a workshop can be arranged.
- The amount paid to FORM? The Executive Manager Community Services advised that the costs for FORM are associated with project management, equipment hire, accommodation etc. It was queried that there may be existing Shire resources available to reduce the costs. The Executive Manager Community Services advised that Council can go back to FORM to negotiate cost items.
- Whether option 1 or 2 is proposed. This question was taken on notice by The Executive Manager Community Services.

Response by Executive Manager Community Services

The proposed budget refers to option 1.

- Is it likely Council will use FORM again? The Executive Manager Community Services advised that there is no commitment at this time however they are keen to do other sites.
- Whether we have advertised for local artists? The Executive Manager Community Services advised that there was a submission/concept from a local artist which was rejected. No advertising or work has been undertaken on the proposal at this stage.
- Whether three quotes are required? The Executive Manager Community Services and Acting CEO advised that if the service is specialised there is no need/staff are unable to obtain 3 quotes. The Executive Manager Community Services advised that FORM will engage the artist with our input and manage the project.

Cr Tinetti returned to the meeting at 6:41 pm.

Council Forum Meeting Notes
20 January 2020

12.5.3 Short Stay Caravan Facilities Feasibility

Clarification was sought in relation to:

- Whether the report was subject to a workshop in late 2019. The Executive Manager Community Services confirmed that the report was workshopped however the costings were not available at the workshop.
- The reason for Wundowie not being included. The Executive Manager Community Services advised that Wundowie was included in a feasibility study which was undertaken for the Wundowie Community Hub and the information is within a separate report. It was further queried the impacts of not including Wundowie in this report should the Wundowie Community Hub not proceed. The Executive Manager Community Services advised that there is no impact as the information has already been collated and is recorded within a separate report.
- Can the short stop proposed on Minson Avenue be used as the 24 hour stop until this is established? The Executive Manager Community Services advised that this is not possible as the legislations stipulates a number of requirements for 24 hour stop points.

12.5.4 Community Representation on Council Committees

Clarification was sought in relation to:

- The sitting fee maximum amount and whether there is consideration for a reduced amount. The Executive Manager Community Services advised that up to \$500 can be paid however \$100 is traditionally what has been paid for the Aboriginal Advisory Group.
- Whether any other Council committees get a sitting fee. The Executive Manager Community Services advised that other committees do not get a sitting fee.
- Whether everyone who has applied is recommended to be included? The Executive Manager Community Services advised that not all have been included, those who do not reside within the Shire are not recommended to be included. The Executive Manager Community Services advised that Officers were surprised with the number of nominations received.

13. MATTERS BEHIND CLOSED DOORS

Gallery left the meeting at 6:50pm.

Cr J E G Williams declared an "Impartiality" interest in item 13.1 - Confidential Shire of Northam Licensing Services as one of her non dependent children holds one of the staff positions affected by this decision.

Cr M I Girak declared an "Impartiality" interest in item 13.1 - Confidential Shire of Northam Licensing Services as she knows the Senior Licensing Officer and

Council Forum Meeting Notes
20 January 2020

some of the customer service staff that may be affected. The extent of her interest is minimal and it will not affect her decision.

13.1 CONFIDENTIAL SHIRE OF NORTHAM LICENSING SERVICES

Refer to confidential addendum.

14. MOTIONS OF WHICH PREVIOUS NOTICE HAS BEEN GIVEN

Nil.

15. URGENT BUSINESS APPROVED BY DECISION

Nil.

16. DECLARATION OF CLOSURE

The Shire President, Cr C R Antonio declared the meeting closed at 7:03pm.

10. ITEMS BROUGHT FORWARD FOR THE CONVENIENCE OF THOSE IN THE PUBLIC GALLERY

Nil.

11. REPORTS OF COMMITTEE MEETINGS

Nil.

12. OFFICER REPORTS

12.1 CEO'S Office

Nil.

12.2 ENGINEERING SERVICES

12.2.1 Shire of Northam W5.6 Verges Policy Review

Address:	N/A
Owner:	Shire of Northam
Applicant:	N/A
File Reference:	2.3.1.2
Reporting Officer:	John Rutherford, Parks and Gardens Manager
Responsible Officer:	Clinton Kleynhans, Executive Manager Engineering Services
Officer Declaration of Interest:	Nil.
Voting Requirement:	Simple Majority
Press release to be issued:	No

BRIEF

For Council to consider adopting the revised draft W5.6 Verges Policy.

ATTACHMENTS

- Attachment 1: W5.6 Verges Policy with marked- up changes
Attachment 2: W5.6 Verges Policy in final format

A. BACKGROUND / DETAILS

W5.6 Verges Policy provides guidelines to the community to achieve aesthetically pleasing outcomes and environmental benefits.

A review has taken place to ensure it continue to align with the Shires informing plans and strategies. Relevant changes from this review have been identified in the Officers Comment section below.

B. CONSIDERATIONS

B.1 Strategic Community / Corporate Business Plan

Theme Area 4: Environment and Heritage.

Outcome 4.1: The Shire of Northam is visually pleasing and easy to find your way around.

Objective: Verges and Roadsides are neat, tidy and attractive.

Theme Area 5: Infrastructure and Service Delivery.

Outcome 5.2: Environmental risks are proactively managed to minimise impact on residents.

Objective: Verges and Roadsides are neat, tidy and attractive.

Theme Area 6: Governance & Leadership.

Outcome 6.1: The Shire of Northam is recognised as a desirable place to live and residents are proud to live here.

Objective: Positive internal and external perceptions about Northam. Foster a sense of community pride.

B.2 Financial / Resource Implications

Nil.

B.3 Legislative Compliance

This Policy works in conjunction with the Local Planning Strategy and Shire of Northam Activities on Thoroughfares, Public Places and Local Trading Laws.

Activities on thoroughfares and Public Places and Trading Local Law 2008

PART 2 – ACTIVITIES ON THOROUGHFARES AND PUBLIC PLACES

Division 1 - General

2.8 Permissible verge treatments

- (1) An owner or occupier of land which abuts on a verge may on that part of the verge directly in front of her or his land install a permissible verge treatment.
- (2) The permissible verge treatments are –
 - (a) the planting and maintenance of a lawn;
 - (b) the planting and maintenance of a garden provided that –
 - (i) clear sight visibility is maintained at all times for a person using the abutting thoroughfare in the vicinity of an intersection or bend in

- the thoroughfare or using a driveway on land adjacent to the thoroughfare for access to or from the thoroughfare; and*
- (ii) *where there is no footpath, a pedestrian has safe and clear access of a minimum width of 2m along that part of the verge immediately adjacent to the kerb;*
- (c) *the installation of an acceptable material; or*
- (d) *the installation over no more than one third of the area of the verge (excluding any vehicle crossing) of an acceptable material in accordance with paragraph (c), and the planting and maintenance of either a lawn or a garden on the balance of the verge in accordance with paragraph (a) or (b).*

B.4 Policy Implications

Upon adoption of the proposed changes, it will be updated in Councils current Policy Manual.

B.5 Stakeholder Engagement / Consultation

The Policy has been reviewed by internal staff, with prior feedback sought from Council

B.6 Risk Implications

Risk Category	Description	Rating (likelihood x consequence)	Mitigation Action
Financial	Non complying development verge approvals	unlikely / Insig. Low(4)	Ensuring that approvals comply with Policy.
Health & Safety	Verge development introduces safety related issues, i.e. vision obstruction	Possible/ Minor Mod (6)	Ensuring that approvals comply with Policy.
Reputation	The aesthetics of the verges is not maintained.	Possible/Med. Mod (9)	Ensure appropriate programs are in place utilising available resources
Service Interruption	N/A	N/A	N/A
Compliance	Each approval required to comply with the policy To ensure that policy is reviewed as per Shire of Northam Corporate Business Plan	Rare/ Medium Mod (3)	Non compliance may result in remedial works being undertaken at the owners cost
Property	Property namely verges in which the	Rare/Med. Low (3)	Ensure appropriate programs are in

	Shire of Northam has a vested interest.		place utilising available resources
	Verges in which the community has been granted approval to developed.	Rare/Med. Low (3)	Approved applicants are required to maintain the verge to the required standard
Environment	Increased maintenance requirements	Possible/Med. Mod (9)	Shire Northam will publicise this document to allow the onus to be placed back on the Community / Resident.

C. OFFICER'S COMMENT

The existing Policy was reviewed by staff with minor amendments made to reflect current practices and acceptable standards.

The following is a summary of the amendments made:

Section	Proposed alteration
Cover Page	Deleted and written into title and Policies to match new policy formatting.
Policy Application	Deleted Paragraph 1 and 2
Objective	Written content taken from original document titled "Purpose"
Vegetable Gardens	Removed as Vegetable gardens are no longer permitted.
Stormwater Infiltration	Removed "on site infiltration of stormwater is desirable as a means of contributing to the replenishment of ground water.
Reticulation	Paragraphs 2 & 3 joined together for formatting purposes. With the following statements removed: <i>Alternatively, the sprinklers should be the pop up variety or a type approved by the Shire; It is preferred to avoid reticulation of the verge altogether.</i>
Verge Compliance Criteria	Rewritten for formatting and clarity.
Verge Development Assistance Scheme	Deleted – no longer applicable to the Shire of Northam.
Verge Paving	Dot point 5, 6 and 7 removed as it is no longer applicable.

Existing Treatments	Verge	Dot point 4 removed as it implies planter boxes are permitted.
Public Awareness		Removed as it no longer applies.
Glossary of Terms		Removed – not required in the new Policy format.
Verge Maintenance		Added service levels to be performed by the Shire on verges.

RECOMMENDATION

That Council adopt W 5.6 Verges Policy as presented, and authorise the CEO to perform minor formatting changes to present the Policy in the new format.

MOTION / COUNCIL DECISION

Minute No: C.3855

Moved: Cr Pollard
Seconded: Cr Mencshelyi

That Council

1. Adopt W 5.6 Verges Policy as presented subject to the following amendments:
 - Introduction, second paragraph - Add the words 'endeavour to' after the words 'owners to' and before the word 'maintain'.
 - Verge Maintenance, item 2 and 3 – Add the words 'at least' after the word 'slashed' and after the words 'once per year'.
2. Authorise the CEO to perform minor formatting changes to present the Policy in the new format.

CARRIED 8/2

The Shire President opened public question time due to a member of the public arriving after this agenda item.

Name: Marie Edmonds.

Question: Can residents plant trees in the middle of the verge?

Response: The Acting Chief Executive Officer advised that this is permitted subject to meeting the requirements of Councils policy.

Debate was held around the motion. Cr Pollard spoke for the motion. Cr Ryan spoke against the motion. Cr Pollard used his right of reply to close the debate.

Attachment 1



Shire of Northam Policy Manual (Section 1)
Policy
W 5.6 Verges Policy

WORKS

W 5.6 Verges Policy

Responsible Department

Executive Manager of Engineering Services

Resolution Number

Resolution Date

Next Scheduled Review

20224

Related Shire Documents

Activities on Thoroughfares, Public Places and Local Trading Law 2010s;

Street Tree Policy;

Related Legislation

Local Government (Uniform Local Provisions) Regulations 1996: 6.

Obstruction of public thoroughfare by things placed and left — Sch. 9.1 cl. 3(1)(a)

POLICY

As per attachment W 5.6.

The Shire supports the efforts of residents and property owners within the Shire designated townsites to develop and maintain verges that contribute to the aesthetic presentation of streetscapes and a sustainable quality environment for the community.

(To be read in conjunction with The Shire's Activities on Thoroughfares and Public Places and Trading Local Law and Policy 5.5 Street Trees)

OBJECTIVES

To support and assist residents and the community generally to achieve aesthetically pleasing outcomes and environmental benefits, in a way that the Shire is not exposed to increased risk of liability claims.

To ensure a balance between legitimate off street parking requirements, streetscape enhancement by landscaping and on-site filtration of storm water.

To manage and resolve hazards and safety issues

To ensure an equitable balance in the level of verge management carried out across the Shire towns.

To support and protect biodiversity.



GUIDELINES	As attached to Policy W 5.6
HISTORY	Adopted: 19/09/2012
REVIEW	Executive Manager, Engineering Services

ATTACHMENT W 5.6 VERGES POLICY

1. BACKGROUND

The street verge has been traditionally described as the area between the road and boundary of an abutting property. The verge provides a safe pedestrian space and vehicular access to properties. The verge generally accommodates public service and local government utilities above and below ground such as street lighting, power, water, stormwater pipes, sewerage, gas and telecommunication cables. The service providers need to access their asset in the verge to install, maintain and/or repairs.

2. PURPOSE

- To value the verge as an important component of the streetscape
- To promote the principles of environmental sustainability and biodiversity
- To provide direction and guidance to residents on appropriate verge treatments
- To encourage ownership by owners to improve and maintain verge presentation
- To provide advice, regulatory control and incentives to property owners to improve verges to an appropriate and consistent stand

OBJECTIVES

To provide guidelines to assist community residents and the community generally to achieve aesthetically pleasing outcomes and environmental benefits of treatments on Shire verges, in conjunction with the Shire's Activities on Thoroughfares, Public Places and Local Trading Laws.

- To value the verge as an important component of the streetscape
- To promote the principles of environmental sustainability and biodiversity
- To provide direction and guidance to the community on appropriate verge treatments
- To encourage adjacent property ownership by owners to improve and maintain verge presentation



- To provide advice and regulatory control and incentives to property owners to improve verges to an appropriate and consistent standard

3. SCOPE

3. POLICY APPLICATION

The Shire recognises that the appearance of street verges is important to owners / occupiers, due to the aesthetics impact on their dwellings and properties.

The following guidelines are provided to maintain safety to the community whilst enabling owners / occupiers to improve the aesthetics and amenity of street verges abutting to their properties.

Any person who wishes to carry out any works on the verge shall do so in accordance with this policy, guidelines and specifications.

4. POLICY

Introduction

The street verge has been traditionally described as the area between the road and boundary of an abutting property. The verge provides a safe pedestrian space and vehicular access to properties. The verge generally accommodates public service and local government utilities above and below ground such as street lighting, power, water, stormwater pipes, sewerage, gas and telecommunication cables. The service providers need to access their asset in the verge to install, maintain and/or repairs.

Due to the extensive amount of verges within the Shire, it is impractical to assign the level of resources that would be required to maintain all verges. The Shire therefore

The Shire will encourage requires and assist where practicable owners/ occupiers to maintain street verges in a way that retains and enhances the street scape whilst minimising water usage. all residents and commercial property owners to endeavour to maintain the verge adjacent to their property, for their own benefit, the benefit of their neighbours and the wider Northam community.

3.1 Community Value

Street verges facilitate an important role in the town site streetscape environment. They provide aesthetic and environmental values, act as a buffer to street noise, provide shade and shelter, provide habitat for fauna and act as linkages, or vegetation corridors, between larger habitat nodes.

3.2 Pride and Ownership



~~Development, improvement and enhancement of verges promotes pride within the community and fosters a sense of verge ownership as an important and valuable component of streetscapes and open space within the Shire townsite.~~

~~3.3~~ — Amenity

~~Suitable and appropriate verge treatments contribute a significant value to the streetscape. The Shire and the community appreciate the visual amenity provided by verges that are maintained and improved by residents.~~

~~3.4~~ — ~~Natural Treatments~~ Permissible Treatments

~~The following treatments are permissible to be installed by the owner or occupier of the adjacent land to that verge. The owner and/ or occupier of who installs a permissible verge is responsible for maintaining the verge in a neat, safe and tidy condition.~~

~~3.4.1~~ — Grass ~~verges are permitted~~ ^(CK1)

~~It is suggested; however, selection of that grass species that is water-wise grass species that are, hardy and sustainable in verge conditions, including shade under trees is suggested. are selected.~~

Garden / 3.4.2 — Plantings

- ~~• of species Species indigenous tolerant to the local environment area and minimising the use of impervious surfaces are recommended.~~
- ~~• Verge treatments are limited to low growing plants and ground covers that are nonhazardous to pedestrians, motorists, and/or cyclists. No plants taller than 75 centimetres in height are to be planted within 10 metres of a road junction or intersection, or in any location where they may obstruct visibility for road users or vehicles exiting from a crossover.~~
- ~~• Landscaping does not create barriers within the verge.~~
- ~~• The plants are to be kept clear of the roadway and any footpath. If there is no footpath, a clear distance of 2 metres from the back of the kerb or edge of a carriageway is to be maintained to allow for the unrestricted passage of pedestrians.~~



- ~~The proposed landscaping provides a positive contribution to the aesthetic presentation of the streetscape~~
- ~~Hedges or similar borders of plants are acceptable if planted to maintain a minimum clearance of 50 centimetres from any existing and/or proposed footpath, and/or crossover and a minimum clearance of 2 metres from the back of kerb or edge of a carriageway.~~
- ~~Reticulation sprinklers shall not be directed onto the footpath or road, and watering is to be restricted to times where any inconvenience to pedestrians, cyclists and motorists is minimised, and should only be watered on the properties allocated watering day.~~
- ~~Appropriate measures are undertaken and maintained to minimise erosion and dust.~~
- ~~Trees per property front allows for the following: standard lot allows for 1 tree, and a corner lot allows 1 tree on the short side and 2 on the long side, 8 metres apart.~~
- ~~The standard alignment for a verge tree is:
 - o 5 metres from any crossovers;
 - o At least 1.5 metres from the road or footpaths;
 - o 10 metres from the truncation; and,
 - o 2.7 metres from the front property line or in line with existing plantings.~~

Other Acceptable Materials ~~Organic Treatments~~

~~3.4.3 Organic mulch is permitted to be installed on verges. However, the mulch is required to be replenished as required and maintained in a safe manner, and shall not encroach surrounding areas outside the verge.~~

~~3.5 Vegetable gardens~~

~~While the Shire encourages the planting of native species indigenous to the local area on verges, installation of vegetable gardens on the verge is permissible. Vegetable gardens on the verge should not stockpile waste, mulch or manure and all spent vegetation should be removed. Stakes, lattice and/or other supporting structures are not considered appropriate due to duty of care and safety reasons.~~

~~3.6 Hardstand Treatments~~



Concrete, segmented and permeable paving materials, artificial turf and other approved hardstand treatments are permitted to be used on the entire verge area. Installation of compacted inorganic materials (such as gravel, crushed brick, limestone or similar) on verges are permitted, subject to the size of the granular materials not causing hazards or inconvenience to pedestrians, cyclists and motorists.

3.7 — Stormwater Water infiltration

~~On site infiltration of stormwater is desirable as a means of contributing to the replenishment of groundwater.~~ Stormwater runoff from large sections of hard surfacing must be ~~contained within the property effectively managed by the landowner,~~ as the runoff can cause localised flooding on roads and adversely impact on the Shire's storm water disposal system and its maintenance.

3.8 — Reticulation

~~3.8.1~~ Where the property owner wishes to install a permanent irrigation system on the verge the water supply is to be from within the adjacent private property boundary. All pipework is to be installed below ground and under footpaths. Sub-surface drip irrigation is preferred where possible to assist conservation of water. ~~Alternatively, the sprinklers should be the pop up variety or a type approved by the Shire.~~

~~3.8.2~~ Reticulation may only be required to establish plants or water-wise verge treatments and this may be possible without the installation of a reticulation system.

~~3.8.3~~ Residents are encouraged to supply sufficient water to the base of the plant or to the plants drip-line to avoid wastage and unnecessary evaporation.

~~3.8.4~~ It is preferable to avoid reticulation of the verge altogether.

3.9 — Non permissible Treatments/Use

~~• T3.9.1~~ The owner / occupier shall not install structures on the street verge. For example, tree house, play structures/equipment, fences, barriers, steps, walls, fountains, ornaments, basketball hoops, ornamental lighting or similar.

~~• 3.9.2~~ The owner / occupier shall not install extrinsic objects on the street verge. For example, bricks, rocks, logs, bollards, garden stakes, bunting, signs or similar.



~~3.9.3~~ The owner / occupier shall not install hard landscaping elements such as borders and or planter boxes around mature street trees.

~~The tethering of boats, trailers and other such items to street trees, street lights and/or road signs is not permitted due to safety issues and the potential to compromise the health of the tree and/or damage infrastructure~~

~~3.9.4 The tethering of boats, trailers and other such items to street trees, street lights and/or road signs is not permitted due to safety issues and the potential to compromise the health of the tree and/or damage infrastructure.~~

~~The use of any hard landscaping elements to create garden edging or retain soil adjacent to any proposed or existing footpaths, crossovers, and or kerbs shall not be permitted.~~

~~The use of loose inorganic materials (stones / rocks / bricks) shall not be permitted, as these may cause potential hazard to pedestrians, cyclists and motorists.~~

3.10 Access by Utility Providers

Service providers, including the Shire, retain the right to access the verge for service maintenance works that may disrupt or damage any verge treatment in accordance with Section 2.13 of the Activities on Thoroughfares Public Places and Local Trading Law 2018:-



4. — Verge Compliance Criteria

In order for applications to install landscape treatments on the verge to be approved, the following criteria will need to be met:

Landscaping does not create barriers within the verge.

* The plants are to be kept clear of the roadway and any footpath. If there is no footpath, a clear distance of 2 metres from the back of the kerb or edge of a carriageway is to be maintained to allow for the unrestricted passage of pedestrians.

- Where a bus stop exists within a verge, the proposed development must provide a minimum 1.5m clearance around the bus stop and between the bus stop and the foot path.
- Temporary barricades for the purpose of establishing verge landscaping are acceptable provided that the materials used do not create a hazard and are identified with an abundance of markers to ensure the safety of pedestrians. Barriers must not be erected across pedestrian access ways, or in a manner which creates a sight line barrier / hazard.
- The general level and grade of the verges is to remain unaltered.
- The treatment is not to create any undue hazard to road users or pedestrians.
- The resident accepts responsibility for the removal or relocation of planting or reticulation if required by the Shire or any public authority and shall maintain the treatment so as not to cause a hazard.
- Should the verge treatment become hazardous, the ratepayer shall agree to remove the treatment at his/her expense. * The ratepayer agrees to indemnify the Shire against any claims that may arise as a result of the treatment.
- The verge shall not be used as a car park for any vehicle including cars, trucks, boats, caravans and so on.
 - The ratepayer shall not remove or prune any tree on street verge. Unless they have an approved verge development for which they are responsible for the maintenance and up-keep of.
- Prior to planting any tree on the road verge, the ratepayer is required to submit an application in the form of a written letter to the Shire, and obtain approval as per the Shire's "Street Tree Policy."
- The resident is to inform the Shire in writing if they wish for to request the their verge not to be sprayed or to be placed on the by having it placed on the "No Spray" list.Register"



~~Trees per property front allows for the following: standard lot allows for 1 tree, and a corner lot allows 1 tree on the short side and 2 on the long side, 8 metres apart.~~

~~The standard alignment for a verge tree is:~~

~~5 metres from any crossovers;~~

~~At least 1.5 metres from the road or footpaths;~~

~~10 metres from the truncation; and~~

~~2.7 metres from the front property line or in line with existing plantings.~~

~~4.1 — Verge treatments are limited to low growing plants and ground covers and be non-hazardous to pedestrians, motorists, and/or cyclists. No plants taller than 75cm in height are to be planted within 10m of a road junction or intersection, or in any location where they may obstruct visibility for road users or vehicles exiting from a crossover.~~

~~4.2 — The proposed landscaping provides a positive contribution to the aesthetic presentation of the streetscape.~~

~~4.3 — Landscaping does not create barriers within the verge.~~

~~4.4 — Dense planting or other low maintenance forms of landscaping is acceptable.~~

~~4.5 — The plants are to be kept clear of the roadway and any footpath. If there is no footpath, a clear distance of 2 metres from the back of the kerb or edge of a carriageway is to be maintained to allow for the unrestricted passage of pedestrians.~~

~~4.6 — Where a bus stop exists within a verge, the proposed development must provide a minimum 1.5m clearance around the bus stop and between the bus stop and the footpath.~~

~~4.7 — The mature height of vegetation will be maintained below 750 mm. However, midstorey plants, particularly those that are indigenous to the area such as grass trees (Xanthorrhoea species) and banksias (Banksia species) are permissible so long as they are not planted within 10m of a road junction or intersection, or in any location where they may obstruct visibility for road users or vehicles exiting from a crossover.~~

~~4.8 — Hedges or similar borders of plants are acceptable if planted to maintain, a minimum clearance of 500 mm from any existing and/or proposed footpath, and/or crossover and a minimum clearance of 2,000 mm from the back of kerb or edge of a carriageway.~~

~~4.9 — Reticulation sprinklers shall not be directed onto the footpath or road, and watering is to be restricted to times where any inconvenience to pedestrians, cyclists and motorists is minimised.~~



~~4.10 — Appropriate measures are undertaken and maintained to minimise erosion and dust.~~

~~4.11 — The use of loose inorganic materials (ie; gravels / stones / rocks / bricks) shall not be permitted, as these may cause potential hazard to pedestrians, cyclists and motorists.~~

~~4.12 — The use of any hard landscaping elements to create garden edging or retain soil adjacent to any proposed or existing footpaths, crossovers, and/or kerbs shall not be permitted.~~

~~4.13 — Temporary barricades for the purpose of establishing verge landscaping are acceptable provided that the materials used do not create a hazard and are identified with an abundance of markers to ensure the safety of pedestrians. Barriers must not be erected across pedestrian access ways, or in a manner which creates a sight line barrier / hazard.~~

~~4.14 — The general level and grade of the verges is to remain unaltered.~~

~~4.15 — The treatment is not to create any undue hazard to road users or pedestrians.~~

~~4.16 — The applicant accepts responsibility for the removal or relocation of planting or reticulation if required by the Shire or any public authority.~~

~~4.17 — The ratepayer shall maintain the treatment so as not to cause a hazard.~~

~~4.18 — Should the verge treatment become hazardous, the ratepayer shall agree to remove the treatment at his/her expense.~~

~~4.19 — The ratepayer agrees to indemnify the Shire against any claims that may arise as a result of the treatment.~~

~~4.20 — The verge shall not be used as a car park for any vehicle including cars, trucks, boats, caravans and so on.~~

~~4.21 — The ratepayer shall not remove or plant any tree on street verge. Requests for street trees shall be made to the Shire according to Policy 5.5 Street Trees.~~

~~4.22 — Verge treatment shall not be over more than one third of the area of the verge (excluding any vehicle crossing).~~

~~5. — Verge Development Approval Process~~

All proposals for landscape treatment of the verge require approval from the Shire of Northam.

In order for applications to install landscape treatments on the verge to be assessed, property owners are required to submit in writing an outline of the landscape



proposal which includes a diagram to illustrate the proposed work including plant species and the layout of any proposed reticulation system(s).

The Shire will then:

- Inspect the location;
- Notify the owner in writing whether the Shire supports or does not support the proposed landscape development;
- On completion of any approved works the Shire will inspect the works;
- Works not carried out in accordance with the relevant approvals will require any noncompliance issues to be rectified; and
- Maintain a register of the site and the approved verge treatment.

6. VERGE DEVELOPMENT ASSISTANCE SCHEME

The objective of providing verge development assistance is to encourage and support property owners to develop and maintain verges that contribute to the aesthetic presentation of streetscapes and a sustainable quality environment for the community.

6.1 Verge Restoration:

The objective of providing verge restoration is to provide a better growing medium for low water demand plantings of low growing shrubs or ground cover plants other than turf. Existing soil/vegetation is removed from the verge to a depth of 50 mm below korb/footpath levels and then replaced with fresh topsoil and levelled. Where a vehicular crossover is no longer used to gain access to the property, a verge restoration will include the removal of the redundant crossover. This scheme is available once only in every 10 years for individual properties.

6.2 Plant Subsidy:

Residential property owners can apply to purchase subsidised low water demand native plants for landscaping the street verge abutting to their properties. The objective of providing subsidised plants is to encourage residents to support biodiversity, water conservation, and the establishment of green corridors to link habitat areas within the townsites. The Shire will subsidise up to a maximum of 40 plants per property each year on a dollar for dollar basis. Plants are available through the native plant subsidy scheme run on an annual basis within the month of May.

6.3 Landscape Design Advice:

Plant selection advice and landscape design expertise is available to residential property owners requiring or seeking assistance in regard to verge



Shire of Northam Policy Manual (Section 1)
Policy
W 5.6 Verges Policy

~~landscaping. The Shire will subsidise assistance to a value of \$100. This scheme will be available once in every 5 years for individual properties.~~

~~Verge Development Assistance Scheme applications will be considered using the following criteria:~~

- ~~• Application must be from the property owner;~~
- ~~• An application for verge restoration will not be considered, where building work or activities within the property have damaged the street verge;~~
- ~~• The proposed verge treatment will improve and sustain the streetscape;~~
- ~~• Preference will be given to native ground covers/shrubs with reduced water demands.~~
- ~~• Applications to participate in one of the above three Verge Assistance Schemes shall be submitted in writing to the Shire of Northam.~~

~~The availability of the verge development assistance scheme will be delivered within the limits of the available budget. Residents are therefore recommended to register their interest early in the financial year to avoid disappointment.~~

~~It is recommended property owners kill any existing turf prior to verge restoration to avoid resprouting. This may be done when the turf is actively growing (spring or autumn) by using weed control mats or biodegradable herbicides.~~

7. Verge Paving

Where there is a legitimate requirement for verge paving and there is no reasonable alternative property owners can apply to pave a portion of the verge directly adjacent to their property.

Proposals for verge paving require approval from the Shire of Northam.

Where the installation of paving to the verge is likely to compromise the safety of pedestrians, cyclists or motorists or the longevity of an existing street tree, the application will not be approved.

Where paving is proposed to provide a footpath between the property boundary and the kerb line, the path is to be 2.0 metres wide.

In order for verge paving proposals to be assessed the property owner is required to submit in writing an outline of their proposed paving plan with a diagram that illustrates the proposed location, alignment, and the materials to be used.

The Shire will then:

- Inspect the location.



Shire of Northam Policy Manual (Section 1)
Policy
W 5.6 Verges Policy

- Notify the owner in writing of whether the Shire approves the application or not.
- On completion of the approved works, the Shire will inspect the works. Works not undertaken in accordance with the relevant approvals will require any noncompliance issues to be rectified.
- Maintain a register of the site and the approved verge treatment.
- ~~• The use of soil reinforcing cells will entitle the property owner to pave up to 70% of the adjacent verge.~~
- ~~• Where the road reserve is narrow and the verge contains a large and mature street tree with a wide spreading canopy, which overshadows the whole verge and which prohibits the establishment of ground covers the adjacent residential property owner may apply to pave up to 70% of the verge consistent with the requirements of this policy.~~
- ~~• Where there is approval to install conventional clay or concrete paving to 70% of the verge the adjacent property owners must make provision for the on-site drainage of storm water within the verge. The adjacent property owner is required to provide detailed plans of the proposed method of storm water infiltration to the Shire for its consideration and approval. The use of soil reinforcing cells (which provide for storm water infiltration) will not require additional drainage provisions.~~
- A minimum two (2) metre paving clearance from any street tree is to be maintained.
- The property owner is responsible for the maintenance of any Shire approved verge paving installation. ~~to acknowledge in writing that any approved verge paving installed within the verge will be maintained by the property owner at grade consistent with the surrounding soil level at all times to ensure safe pedestrian access.~~
- The property owner is responsible for the reinstatement of any verge paving removed by the Shire or Utility Service Provider in providing routine maintenance of services and projects approved by the Shire. ~~to acknowledge in writing that there is no responsibility on the part of the Council or utility service provider to reinstate verge paving removed to provide for routine maintenance of services or projects approved by Council.~~



- Commercial areas are treated separately from residential verges as paving is permitted to 100% of the verge in commercial areas.

*

8. Property Development

To minimise the risk of tree damage/death a minimum construction clearance of two (2) metres is required from the base of an existing street tree. Where excavation to a depth greater than 100mm is proposed the clearance should be greater than three (3) metres from the base of an existing street tree.

9. Existing Verge Treatments

A verge treatment which was installed prior to the commencement day of the Activities on Thoroughfares Public Places and Local Trading Law 2008 is to be taken to be a permissible verge treatment for so long as the verge treatment remains of the same type and continues to comply with the former provisions.

Where verge treatments are not consistent with the policy and are identified as safety hazards, the Shire will request the property owner to carry out remedial works.

Where the owner of the property is unable or unwilling to complete remedial works, the Shire will complete these works with ~~the~~ property owner will be being liable for the cost thus incurs ~~any cost incurred~~

Existing verge treatments, which are not consistent with this policy, are required to be rectified, on the following basis:

- Identified hazards or safety issues ie; tree houses, play equipment or any structure that has not been approved etc, boats and/or trailers tethered to street trees etc, landscaping that has thorns, spear-like leaves or plants that are known to be toxic etc, landscaping that impedes sightlines/pedestrian access etc, removal within 14 days of notification.
- Rectification within 14 days of notification. Where an existing verge treatment is identified to present an immediate hazard, the Shire will rectify within 24 hours. The ratepayer abutting to the verge will be liable for the cost thus incurs. [CK2]
- Paving (not approved by the Shire of Northam) in excess of areas defined in this policy is to be rectified within 60 days of notification [CK3].



~~Hard Landscaping elements including boarders and or planted boxes is to be removed within 60 days.~~

- ~~Planter boxes/borders not constructed to meet Australian Standards or industry standards; or constructed to a height greater than 150mm and/or within 500 mm of an existing footpath/crossover and/or within 2,000 mm of the kerb line, require rectification within 60 days.~~

~~Residents and commercial property owners are encouraged to maintain the verge adjacent to their property, for their own benefit, the benefit of their neighbours and the benefit of the wider Northam community.~~

~~10. PUBLIC AWARENESS~~

~~The Shire will acknowledge residents' efforts to develop a sustainable verge landscape via a 'Sustainable Verge Award' each year in spring. The award will target verge landscapes which contribute to the Shire's green objectives. The award is available for two categories' residential and commercial/schools.~~

~~The award is judged on the following criteria: biodiversity; water wise strategies; design; maintenance and any unique aspects. Nomination forms are available at the Administration Centre, and can be submitted from August to mid September annually.~~

~~Public awareness programs to highlight the responsibilities of residents and the Shire on the issues of planting and maintenance of verge treatment will be undertaken, including articles placed from time to time (quarterly) in the Post newspaper and Talk about Northam newsletter. The articles should include all aspects of verge planting and maintenance, including responsibility and relevant Local Laws.~~

~~11. GLOSSARY OF TERMS~~

~~**Street Verge:** Portion of road reserve between the property boundary and edge of carriageway (kerb line).~~

~~**Street Tree:** A tree planted and maintained by the Shire and is typically situated at the 2.7 metre alignment off the property boundary.~~

~~**Verge Treatment:** Landscaping of the portion of street verge not occupied by a footpath or crossover. Typically involves the planting of grass, ground covers or low shrubs and may include reticulation or paving.~~



Verge Restoration: The removal of any existing treatment and excavation of soil up to 100mm below existing paved levels. Topsoil is placed and levelled so that the new soil is flush with any existing paving (footpath, crossover, kerbing, etc).

Soft landscaping: Refers to grass, ground cover and shrubs

Hard Landscaping: Refers to retaining structures or edging / borders.

Paving: Refers to clay or concrete paving materials for footways or hardstand for parking of vehicles.

Structures: Refers to built structures

Verge Maintenance

Property owners throughout the Shire are encouraged. The Shire encourages property owners to maintain and/or improve the verge area outside their property, in a manner that ensures the safety of themselves and / or pedestrians and road users.

The Shire of Northam aims to create a visually pleasing community, inclusive of tidy and attractive verges and roadsides.

The Shire will perform an annual verge maintenance program consisting of the following where practicable:

- Town site verges will be sprayed at least once per year;
- Town site verges will be slashed at least once per year where the adjoining property is privately owned and vacant;
- Town site verges which adjoin property owned by the Shire will be slashed at least once per year and maintained to a standard that is deemed acceptable by Council;
- Rural verges will be sprayed and slashed throughout the year in an effort to reduce grass loadings. Areas of focus will be assessed annually and addressed within budget constraints.
- Spray and slash a minimum 1.5m clearance around a registered bus stop.

Attachment 2



Shire of Northam Policy Manual (Section 1)
Policy
W 5.6 Verges Policy

WORKS

W 5.6 Verges Policy

Responsible Department

Engineering Services

Resolution Number

Resolution Date

Next Scheduled Review

2022

Related Shire Documents

Activities on Thoroughfares Public Places and Local Trading Law 2018;
Street Tree Policy

Related Legislation

Local Government (Uniform Local Provisions) Regulations 1996: 6.
Obstruction of public thoroughfare by things placed and left — Sch. 9.1 cl. 3(1)(a)

OBJECTIVES

To provide guidelines to assist residents and the community generally to achieve aesthetically pleasing outcomes and environmental benefits of treatments on Shire verges, in conjunction with the Shire's Activities on Thoroughfares, Public Places and Local Trading Laws.

- To value the verge as an important component of the streetscape
- To promote the principles of environmental sustainability and biodiversity
- To provide direction and guidance to the community on appropriate verge treatments
- To encourage adjacent property owners to improve and maintain verge presentation
- To provide advice and regulatory control to property owners
- to improve verges to an appropriate and consistent standard.

SCOPE

Any person who wishes to carry out any works on the verge shall do so in accordance with this policy, guidelines and specifications.



POLICY

Introduction

The street verge has been traditionally described as the area between the road and boundary of an abutting property. The verge provides a safe pedestrian space and vehicular access to properties. The verge generally accommodates public service and local government utilities above and below ground such as street lighting, power, water, stormwater pipes, sewerage, gas and telecommunication cables. The service providers need to access their asset in the verge to install, maintain and/or repairs.

Due to the extensive amount of verges within the Shire, it is impractical to assign the level of resources that would be required to maintain all verges. The Shire therefore requires all residents and commercial property owners to endeavour to maintain the verge adjacent to their property, for their own benefit, the benefit of their neighbours and the wider Northam community.

Community Value

Street verges facilitate an important role in the town site streetscape environment. They provide aesthetic and environmental values, act as a buffer to street noise, provide shade and shelter, provide habitat for fauna and act as linkages, or vegetation corridors, between larger habitat nodes.

Amenity

Suitable and appropriate verge treatments contribute a significant value to the streetscape. The Shire and the community appreciate the visual amenity provided by verges that are maintained and improved by residents.

Permissible Treatments

The following treatments are permissible to be installed by the owner or occupier of the adjacent land to that verge. The owner and/ or occupier of who installs a permissible verge is responsible for maintaining the verge in a neat, safe and tidy condition.

Grass Verges

It is suggested that water-wise grass species that are hardy and sustainable in verge conditions, including shade under trees are selected.

Garden / Plantings

- Species tolerant to the local environment are recommended.



- Verges treatments are limited to low growing plants and ground covers that are nonhazardous to pedestrians, motorists, and/or cyclists. No plants taller than 75 centimetres in height are to be planted within 10 metres of a road junction or intersection, or in any location where they may obstruct visibility for road users or vehicles exiting from a crossover.
- Landscaping does not create barriers within the verge.
- The plants are to be kept clear of the roadway and any footpath. If there is no footpath, a clear distance of 2 metres from the back of the kerb or edge of a carriageway is to be maintained to allow for the unrestricted passage of pedestrians.
- The proposed landscaping provides a positive contribution to the aesthetic presentation of the streetscape
- Hedges or similar borders of plants are acceptable if planted to maintain, a minimum clearance of 50 centimetres from any existing and/or proposed footpath, and/or crossover and a minimum clearance of 2 metres from the back of kerb or edge of a carriageway.
- Reticulation sprinklers shall not be directed onto the footpath or road, and watering is to be restricted to times where any inconvenience to pedestrians, cyclists and motorists is minimised, and should only be watered on the properties allocated watering day.

Organic Treatments

Organic mulch is permitted to be installed on verges. However, the mulch is required to be replenished as required and maintained in a safe manner, and; shall not encroach surrounding areas outside the verge.

Hardstand Treatments

Concrete, segmented and permeable paving materials, artificial turf and other approved hardstand treatments are permitted to be used on the entire verge area. Installation of compacted inorganic materials (such as gravel, crushed brick, limestone or similar) on verges are permitted, subject to the size of the granular materials not causing hazards or inconvenience to pedestrians, cyclists and motorists.

Stormwater Water infiltration

Stormwater runoff from large sections of hard surfacing must be effectively managed by the landowner, as the runoff can cause localised flooding on roads and adversely impact on the Shire's storm water disposal system and its maintenance.

Reticulation



Where the property owner wishes to install a permanent irrigation system on the verge the water supply is to be from within the adjacent private property boundary. All pipework is to be installed below ground and under footpaths. Sub-surface drip irrigation is preferred where possible to assist conservation of water.

Reticulation may only be required to establish plants or water-wise verge treatments and this may be possible without the installation of a reticulation system. Residents are encouraged to supply sufficient water to the base of the plant or to the plants drip-line to avoid wastage and unnecessary evaporation.

Non permissible Treatments/Use

- The owner / occupier shall not install structures on the street verge. For example, tree house, play structures/equipment, fences, barriers, steps, walls, fountains, ornaments, basketball hoops, ornamental lighting or similar.
- The owner / occupier shall not install extrinsic objects on the street verge. For example, bricks, rocks, logs, bollards, garden stakes, bunting, signs or similar.
- The owner / occupier shall not install hard landscaping elements such as borders and or planter boxes around mature street trees.
- The tethering of boats, trailers and other such items to street trees, street lights and/or road signs is not permitted due to safety issues and the potential to compromise the health of the tree and/or damage infrastructure
- The use of any hard landscaping elements to create garden edging or retain soil adjacent to any proposed or existing footpaths, crossovers, and or kerbs shall not be permitted.

Access by Utility Providers

Service providers, including the Shire, retain the right to access the verge for service maintenance works that may disrupt or damage any verge treatment in accordance with Section 2.13 of the Activities on Thoroughfares Public Places and Local Trading Law 2018;



Verge Compliance Criteria

- Where a bus stop exists within a verge, the proposed development must provide a minimum 1.5m clearance around the bus stop and between the bus stop and the foot path.
- Temporary barricades for the purpose of establishing verge landscaping are acceptable provided that the materials used do not create a hazard and are identified with an abundance of markers to ensure the safety of pedestrians. Barriers must not be erected across pedestrian access ways, or in a manner which creates a sight line barrier / hazard.
- The general level and grade of the verges is to remain unaltered.
- The treatment is not to create any undue hazard to road users or pedestrians.
- The resident accepts responsibility for the removal or relocation of planting or reticulation if required by the Shire or any public authority and shall maintain the treatment so as not to cause a hazard.
- Should the verge treatment become hazardous, the ratepayer shall agree to remove the treatment at his/her expense.
- The verge shall not be used as a car park for any vehicle including cars, trucks, boats, caravans and so on.
- The ratepayer shall not remove or prune any tree on street verge. Unless they have an approved verge development for which they are responsible for the maintenance and up-keep of.
- Prior to planting any tree on the road verge, the ratepayer is required to submit an application in the form of a written letter to the Shire, and obtain approval as per the Shire's "Street Tree Policy."
- The resident is to inform the Shire in writing if they wish for their verge not to be sprayed by having it placed on the "No Spray Register"

Verge Development Approval Process

All proposals for landscape treatment of the verge require approval from the Shire of Northam.

In order for applications to install landscape treatments on the verge to be assessed, property owners are required to submit in writing an outline of the landscape proposal which includes a diagram to illustrate the proposed work including plant species and the layout of any proposed reticulation system(s).



The Shire will then:

- Inspect the location;
- Notify the owner in writing whether the Shire supports or does not support the proposed landscape development;
- On completion of any approved works the Shire will inspect the works;
- Works not carried out in accordance with the relevant approvals will require any noncompliance issues to be rectified; and
- Maintain a register of the site and the approved verge treatment.

Verge Paving

Where there is a legitimate requirement for verge paving and there is no reasonable alternative property owners can apply to pave a portion of the verge directly adjacent to their property.

Proposals for verge paving require approval from the Shire of Northam.

Where the installation of paving to the verge is likely to compromise the safety of pedestrians, cyclists or motorists or the longevity of an existing street tree, the application will not be approved.

Where paving is proposed to provide a footpath between the property boundary and the kerb line, the path is to be 2 metres wide.

In order for verge paving proposals to be assessed the property owner is required to submit in writing an outline of their proposed paving plan with a diagram that illustrates the proposed location, alignment, and the materials to be used.

The Shire will then:

- Inspect the location.
- Notify the owner in writing of whether the Shire approves the application or not.
- On completion of the approved works, the Shire will inspect the works. Works not undertaken in accordance with the relevant approvals will require any noncompliance issues to be rectified.
- Maintain a register of the site and the approved verge treatment.
- A minimum two (2) metre paving clearance from any street tree is to be maintained.
- The property owner is responsible for the maintenance of any Shire approved verge paving installation.



- The property owner is responsible for the reinstatement of any verge paving removed by the Shire or Utility Service Provider in providing routine maintenance of services and projects approved by the Shire.
- Commercial areas are treated separately from residential verges as paving is permitted to 100% of the verge in commercial areas.

Property Development

To minimise the risk of tree damage/death a minimum construction clearance of two (2) metres is required from the base of an existing street tree. Where excavation to a depth greater than 100mm is proposed the clearance should be greater than three (3) metres from the base of an existing street tree.

Existing Verge Treatments

A verge treatment which was installed prior to the commencement day of the *Activities on Thoroughfares Public Places and Local Trading Law 2008* is to be taken to be a permissible verge treatment for so long as the verge treatment remains of the same type and continues to comply with the former provisions.

Where verge treatments are not consistent with the Policy and are identified as safety hazards, the Shire will request the property owner to carry out remedial works.

Where the owner of the property is unable or unwilling to complete remedial works, the Shire will complete these works, with the property owner being liable for any cost incurred.

Verge Maintenance

Property owners throughout the Shire are encouraged to maintain and/or improve the verge area outside their property, in a manner that ensures the safety of themselves and / or pedestrians and road users.

The Shire of Northam aims to create a visually pleasing community, inclusive of tidy and attractive verges and roadsides.

The Shire will perform an annual verge maintenance program consisting of the following where practicable:

- Town site verges will be sprayed at least once per year;
- Town site verges will be slashed at least once per year where the adjoining property is privately owned and vacant;



*Shire of Northam Policy Manual (Section 1)
Policy
W 5.6 Verges Policy*

- Town site verges which adjoin property owned by the Shire will be slashed at least once per year and maintained to a standard that is deemed acceptable by Council;
- Rural verges will be sprayed and slashed throughout the year in an effort to reduce grass loadings. Areas of focus will be assessed annually and addressed within budget constraints.
- Spray and slash a minimum 1.5m clearance around a registered bus stop.

UNCONFIRMED

12.2.2 Replacement Vehicle for Works Manager – Northam Operations Depot

Address:	
Owner:	Shire of Northam
Applicant:	Internal Report
File Reference:	8.2.4.6
Reporting Officer:	Sue Connell, Project Contracts Administration Officer
Responsible Officer:	Clinton Kleynhans, Executive Manager Engineering Services
Officer Declaration of Interest:	Nil
Voting Requirement:	Absolute Majority
Press release to be issued:	Nil

BRIEF

For Council to endorse the out of budget expenditure to replace the Works Manager Ute, registration N1 1075 that was in a roll over and damaged beyond economic repair.

ATTACHMENTS

Attachment 1: Statement from D Clements Smash Repairs.
Attachment 2: Confirmation from Insurer.

A. BACKGROUND / DETAILS

The Ute was involved in a single vehicle incident (roll over) on Spencers Brook Road on 9th December 2019. An insurance claim was lodged on the 16th December 2019. It was determined to be a write-off and confirmation of reimbursement of the New Replacement Vehicle was received on 11 January 2020 for full replacement value.

The new replacement Cost of the vehicle is \$31,204.70.

As the purchase was not included in the original adopted budget, Council is required to endorse the replacement of this vehicle.

The replacement vehicle is a 2020 Ford Ranger, Turbo Diesel XL 4x2 2.2LT Automatic, Dual Cab which is supplied by Valley Ford Northam Hyundai.

B. CONSIDERATIONS

B.1 Strategic Community / Corporate Business Plan

Theme Area: 5 – Infrastructure and Service Delivery

Outcome: 5.3 – To have a well-maintained community infrastructure and services to a standard expected of a regional centre.

Objective: Deliver infrastructure projects effectively, on budget and schedule, aligned with local community and infrastructure projects.

Maintain an effective and safe regional road network

B.2 Financial / Resource Implications

As per the Shire of Northam's Motor Vehicle Insurance Policy there is \$1000 Excess applicable, which will be funded through the existing plant replacement program budget.

B.3 Legislative Compliance

Nil.

B.4 Policy Implications

Nil.

B.5 Stakeholder Engagement / Consultation

Nil.

B.6 Risk Implications

Risk Category	Description	Rating (likelihood x consequence)	Mitigation Action
Financial	N/A	N/A	N/A
Health & Safety	N/A	N/A	N/A
Reputation	N/A	N/A	N/A
Service Interruption	Inconvenience caused by Works Manager having no vehicle	Alm. Cert /Med High(15)	Ensure vehicle is replaced in a timely manner
Compliance	N/A	N/A	N/A
Property	Replacement vehicle is fit not for purpose	Possible / Minor Mod (6)	Ensure replacement vehicle is still fit for purpose, even though a vehicle is aimed to be selected that has a minimum replacement time, and lowest out of pocket expense, if any
Environment	N/A	N/A	N/A

C. OFFICER'S COMMENT

It is recommended that Council endorse the purchase of a new vehicle to replace the vehicle that was damaged and written off as a total loss by the Shire's Insurer.

RECOMMENDATION / COUNCIL DECISION

Minute No: C.3856

Moved: Cr Little

Seconded: Cr Mencshelyi

That Council, endorse by absolute majority the out of budget expenditure of \$31,204.70 excluding GST for the purchase of one only 2020 Ford Ranger, Turbo Diesel XL 4x2 2.2LT Automatic, Dual Cab as quoted by Valley Ford Northam Hyundai, with the purchase being fully funded by Insurance Claim Number 6013953.

CARRIED 10/0
BY ABSOLUTE MAJORITY

Attachment 1

Crashzone.com.au It's free - 35 2240275

D CLEMENTS SMASH REPAIRS

16 Oliver Street (PO Box 471) Northam Western Australia 6401
Phone: 08 96 222778, Fax: 08 96 225891
Repairer Licence No: MRB 6157
Email: clements.smash@westnet.com.au
ABN: 48 409 814 308

Estimate No:12092

Quote Date: 18/12/2019
Owner: SHIRE OF NORTHAM, Mob 96221099, Fax 96211576
Owner Address: NORTHAM DEPOT
Vehicle: HOLDEN COLORADO
Reg No: N11075
VIN:
Colour:
Odometer:
Insurance:
Claim #:
Estimator:

Other	\$
IT IS OF MY OPINION THAT THIS VEHICLE TO BE NON-REPAIRABLE - WRITE OFF	
Sub Total	\$0.00
Total Labour Hrs	0.00
Total Labour	\$0.00
<hr/>	
Total	\$0.00
GST	\$0.00
Grand Total	\$0.00

Attachment 2

From: AUZ_National Motor Claims <motor.claims@zurich.com.au>
Sent: Saturday, 11 January 2020 11:48 AM
To: Cheryl Greenough <governance@northam.wa.gov.au>
Cc: AUZ_National Motor Claims <motor.claims@zurich.com.au>
Subject: Claim # 6013953/N11075/Shire of Northam

Cheryl,

Our ref : 60143953
Rego : N11075
Date of Loss : 9/12/2019

Thanks for your time on the phone today.

In regards to the settlement as the vehicle is a total loss and less than three years old we are able to offer yourselves settlement under our replacement vehicle extension.

We would ask that the Shire obtain a quote from a dealer to replace your vehicle, we can then base settlement on that quote, including registration fees, delivery charges and stamp duty.

Could you also send thru a copy of the registration papers for our file.

Let me know if I can assist further,

Thanks,

Kind Regards,

Chris Reid
Claims Advisor

Zurich Australian Insurance Ltd
Lv 2, 58 Kings Park Road, West Perth, WA 6005
PO Box 442, West Perth, WA 6872

+61 8 9261 1460 (Direct)
+61 8 9261 1390 (Fax)
Internal Ext 4460
chris.reid@zurich.com.au
www.zurich.com.au

12.3 DEVELOPMENT SERVICES

12.3.1 Proposed Road Dedication – Great Eastern Highway, Coates Gully

Address:	Great Eastern Highway, Coates Gully
Owner:	Various
Applicant:	Main Roads WA
File Reference:	6.1.2.103
Reporting Officer:	Jacky Jurmann, Manager Planning Services
Responsible Officer:	Chadd Hunt, Executive Manager Development Services
Officer Declaration of Interest:	Nil
Voting Requirement:	Simple Majority
Press release to be issued:	No

BRIEF

Main Roads Western Australia (MRWA), in conjunction with their development work at Coates Gully on Great Eastern Highway between 56.65 – 67.45 SLK, have requested the Shire to resolve to dedicate affected portions of private land as road reserve in accordance with the requirements of the *Land Administration Act 1997* (LAA).

ATTACHMENTS

Attachment 1: Site Plan.
Attachment 2: MRWA Correspondence & Plans.

A. BACKGROUND / DETAILS

MRWA is undertaking development work on the portions of the Great Eastern Highway in the area known as Coates Gully.

The 4 bridges shown on the Site Plan (**Attachment 1**) have reached the end of their design life and MRWA envisage that funding will be made available to progressively replace these bridges with culverts and construct road tie-ins on the approaches to each bridge.

It is proposed to replace at least 2 bridges in 2020/21 depending on the amount of funding available.

MRWA have finalised the road design work and is completing the required approvals, including environmental assessment and land acquisitions.

There are 3 lots affected by the proposed works – Lots 801, 3754 and 7408. MRWA are consulting all affected private landowners in regards to the proposed works.

Lot 801 contains an LED advertising sign that is located within the acquisition area and will require relocation or removal. A development application has recently been received by the Shire to relocate the LED advertising sign, which is currently under assessment. Main Roads have advised that they have no objections to the relocation of the sign on the condition that the sign is removed or relocated at the Applicant's expense if the (new) site is required for future roadworks.

B. CONSIDERATIONS

B.1 Strategic Community / Corporate Business Plan

Theme Area 5: Infrastructure & Service Delivery

Outcome 5.3: To have safe, well-maintained community infrastructure and services to a standard expected on a Regional Centre.

Objective: Maintain an efficient and safe regional road network.

B.2 Financial / Resource Implications

There are no financial / resource implications associated with this proposal. MRWA has indemnified the Shire and Minister for Lands against any claims that may arise as a result of the dedications relating to widening of Great Eastern Highway, in accordance with section 5694) of the LAA.

B.3 Legislative Compliance

Council resolution is a requirement of the *Land Administration Act 1997*.

B.4 Policy Implications

There are no policy implications associated with this proposal.

B.5 Stakeholder Engagement / Consultation

MRWA are consulting with all affect parties.

B.6 Risk Implications

Risk Category	Description	Rating (consequence x likelihood)	Mitigation Action
Financial	MRWA development proposal.	Low (1)	Nil.
Health & Safety	N/A	N/A	N/A
Reputation	Procedure not followed.	Low (1)	Resolution worded as per MRWA request.

Risk Category	Description	Rating (consequence x likelihood)	Mitigation Action
Service Interruption	N/A	N/A	N/A
Compliance	Procedure not followed.	Low (1)	Resolution worded as per MRWA request.
Property	N/A	N/A	N/A
Environment	Clearing may be required as part of works.	Low (3)	MRWA to obtain relevant clearing permits.

C. OFFICER'S COMMENT

In accordance with section 56 of the *Land Administration Act 1997*, local governments are the only body able to dedicate roads, and therefore, as requested by MRWA, a resolution of Council is required.

Following Shire resolution, the Department of Planning, Lands and Heritage will arrange for the Minister of Lands to dedicate the road once the land acquisitions have been finalised.

MRWA will keep the Shire informed on the progress of this matter, including the funding and time of the road construction works.

RECOMMENDATION / COUNCIL DECISION

Minute No: C.3857

Moved: Cr Little

Seconded: Cr Williams

That Council resolves to dedicate the land the subject of Main Roads Dealing Plans 1960-205, 1960-206 and 1960-207 as a road pursuant to section 56 of the *Land Administration Act 1997*.

CARRIED 10/0

Clarification was sought in relation to the wording of the recommendation with respect to why the wording road was used as opposed to road reserve. The Executive Manager Development Services advised that the wording has been recommended by Main Roads WA as detailed within the attachment.

The Coordinator Governance / Administration left the meeting at 5:50pm.

Attachment 1

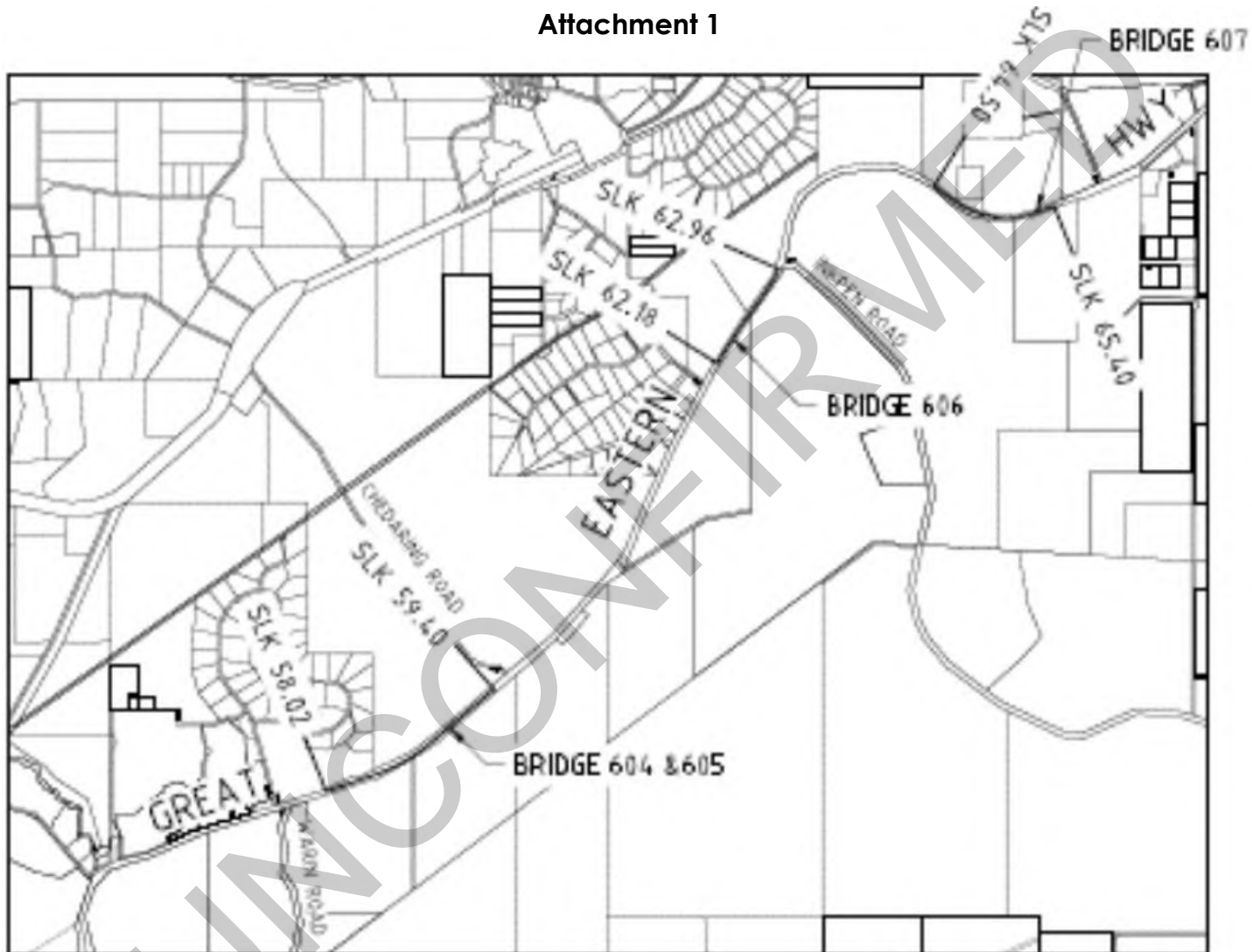

SITE PLAN

Attachment 2



Enquiries: Russell Baulch
Our Ref: 18/9238

4 December 2019

Jason Whiteaker
Chief Executive Officer
Shire of Northam
PO Box 613
NORTHAM WA 6401

Dear Jason

GREAT EASTERN HIGHWAY UPGRADE WORKS – COATES GULLY

Main Roads is undertaking development work at Coates Gully on Great Eastern Highway between 58.65 - 67.45 SLK.

The four bridges as shown on the Site Plan below have reached the end of their design life and it is likely that funding will be made available to progressively replace these bridges with culverts and construct road tie-ins on the approaches to each bridge.



SITE PLAN

Main Roads Western Australia
Northam Office: PO Box 333, Northam WA 6401
Narrogin Office: PO Box 194, Narrogin WA 6312

mainroads.wa.gov.au
wheatbelt@mainroads.wa.gov.au
Northam: 08 9622 4777 | Narrogin: 08 9881 0503



It is proposed that at least two bridges will be replaced in 2020/21, with the actual extent of works subject to confirmation on the amount available funding. Main Roads will keep the Shire updated as to works to be completed in 2020/21 and subsequently in 2021/22.

Main Roads has finalised road design work for the replacement of the bridges and is completing required approvals, including environment and road widening land acquisitions.

Road Dedication

To enable the land to be dedicated as road reserve it is a requirement of the *Land Administration Act 1997 (LAA)* that local governments resolve to dedicate the road.

Attached for consideration by Council are the private land requirements for road widening as shown on Main Roads drawing numbers 1960-205, 1960-206 and 1960-207.

Main Roads is consulting with all affected private land owners and it is noted that the LED advertising sign on Lot 801 is within the land acquisition area and will require removal or relocation by the landowner. As per my email to the Shire on the 24 October 2019, Main Roads would not be able to support an extension to the current Shire approval for the sign.

It would be appreciated if Council could consider this matter at its next meeting and provide the following statement in a letter to Main Roads marked for my attention. This will satisfy the requirements of the Department of Planning, Lands and Heritage, who will be arranging dedication when the land has been acquired.

"Council at its ordinary meeting held on (Day Month Year) passed a resolution for the dedication of the land the subject of Main Roads Land Dealing Plans 1960-205, 1960-206 and 1960-207 as a road pursuant to section 56 of the Land Administration Act 1997."

MRWA indemnifies the Shire and Minister for Lands against any claims that may arise as a result of the dedications relating to widening of Great Eastern Highway, in accordance with section 56(4) of the LAA.

Main Roads officers would be available to attend the Council meeting to discuss the project and address any questions if this would be considered beneficial.

Should you have any enquiries regarding this referral, please do not hesitate to contact Russell Baulch, Land Manager by email at russell.baulch@mainroads.wa.gov.au or telephone on 9622 4737 or 0400 220 497.

Yours sincerely



Craig Manton
Regional Manager

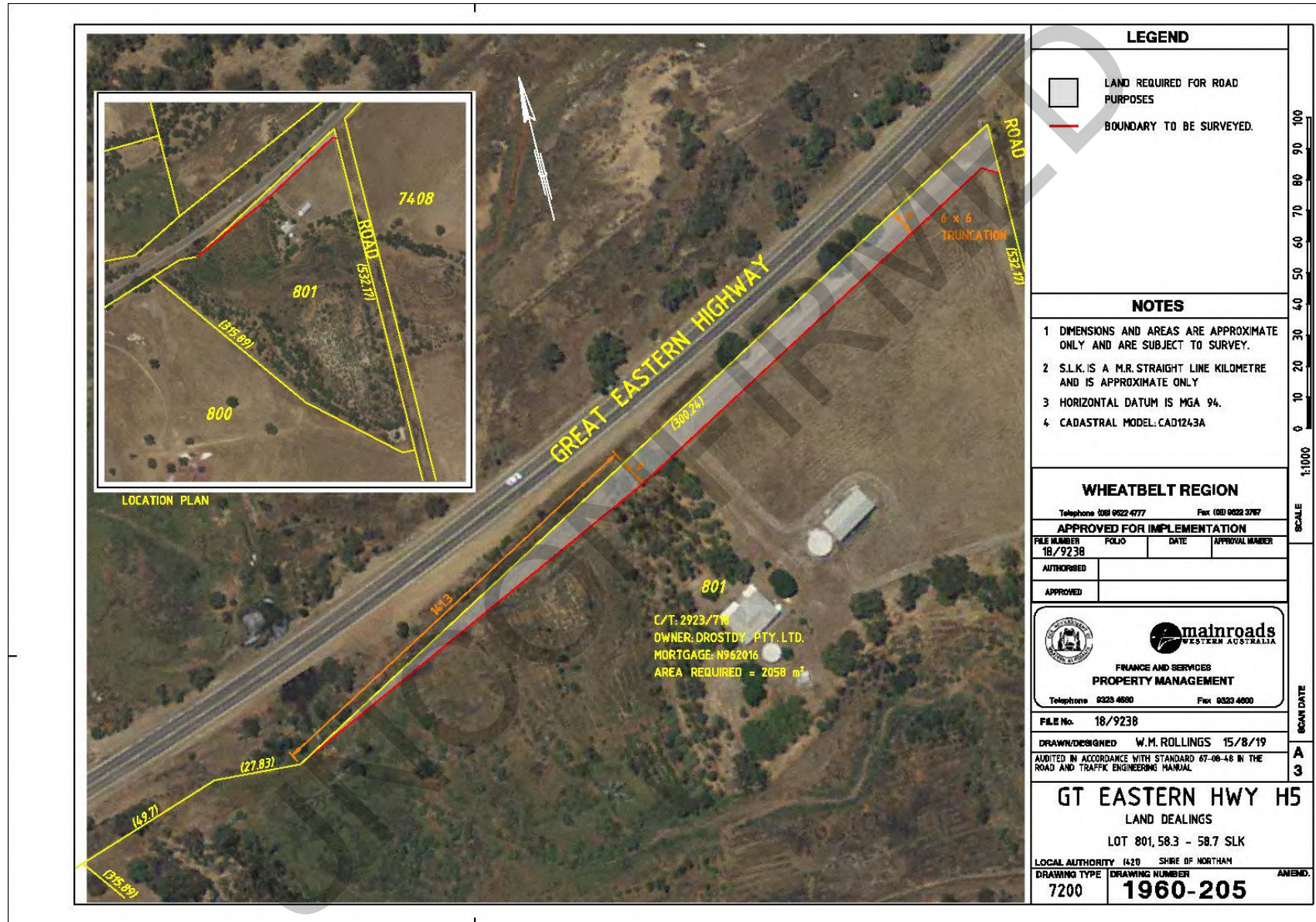

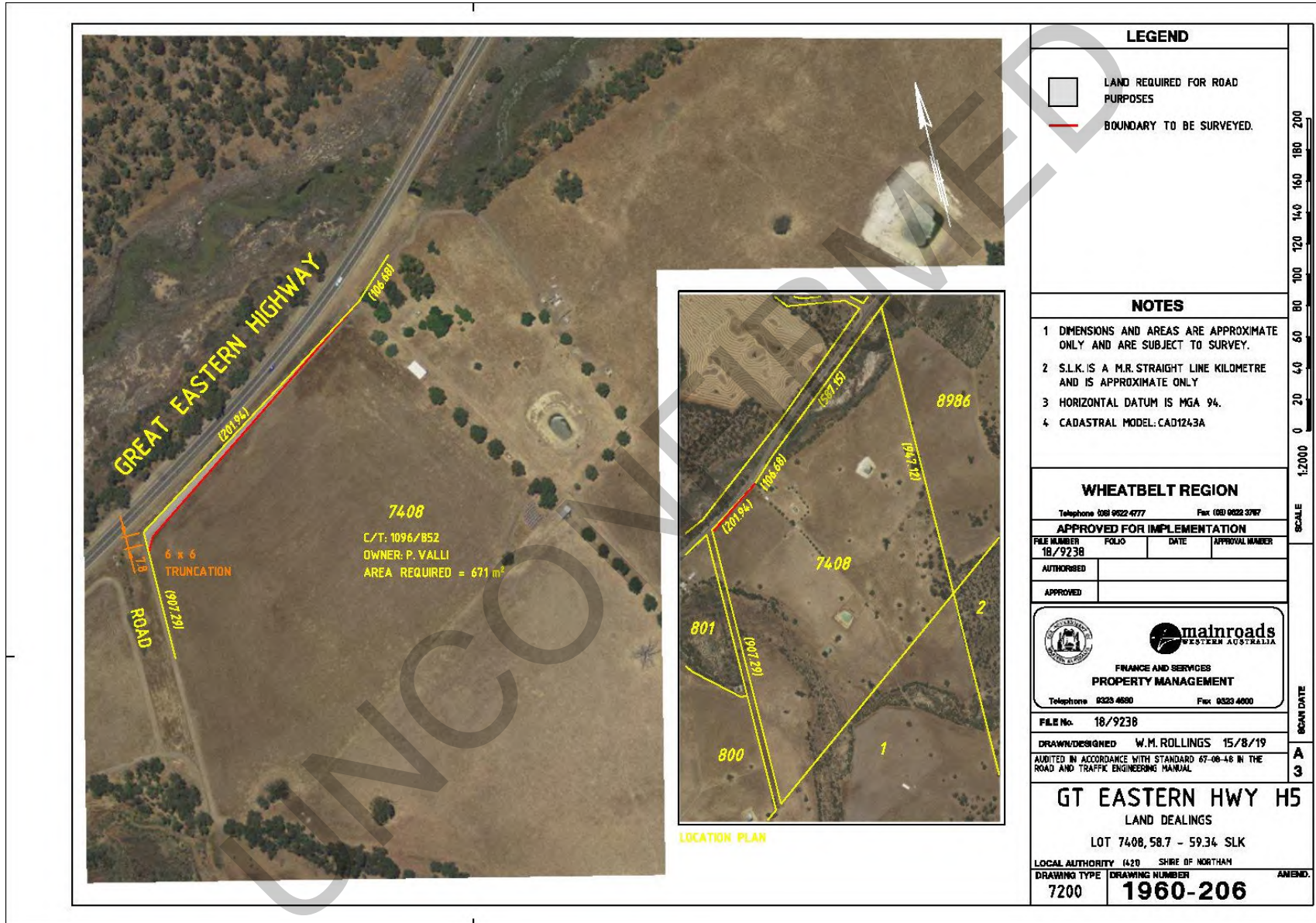

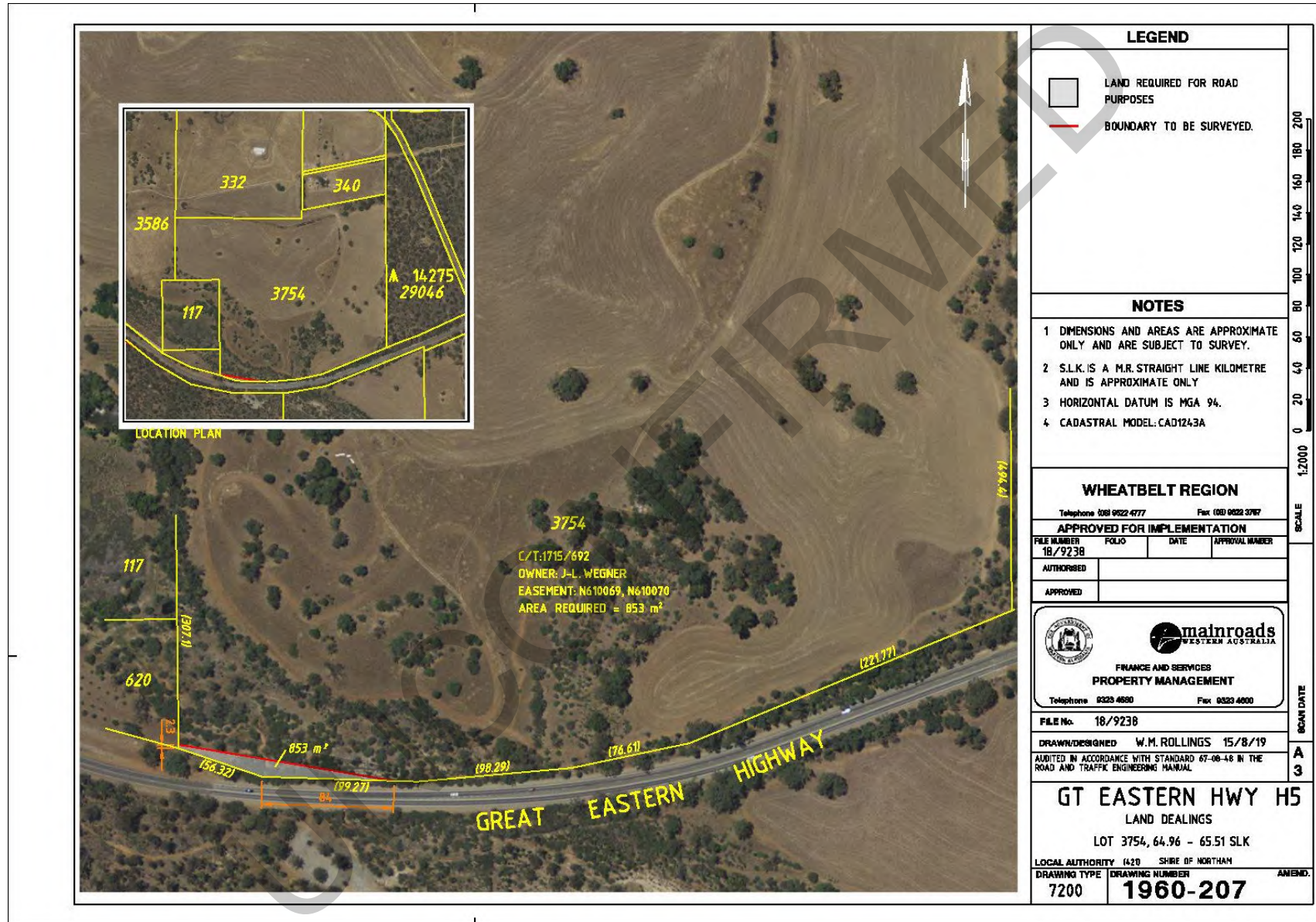

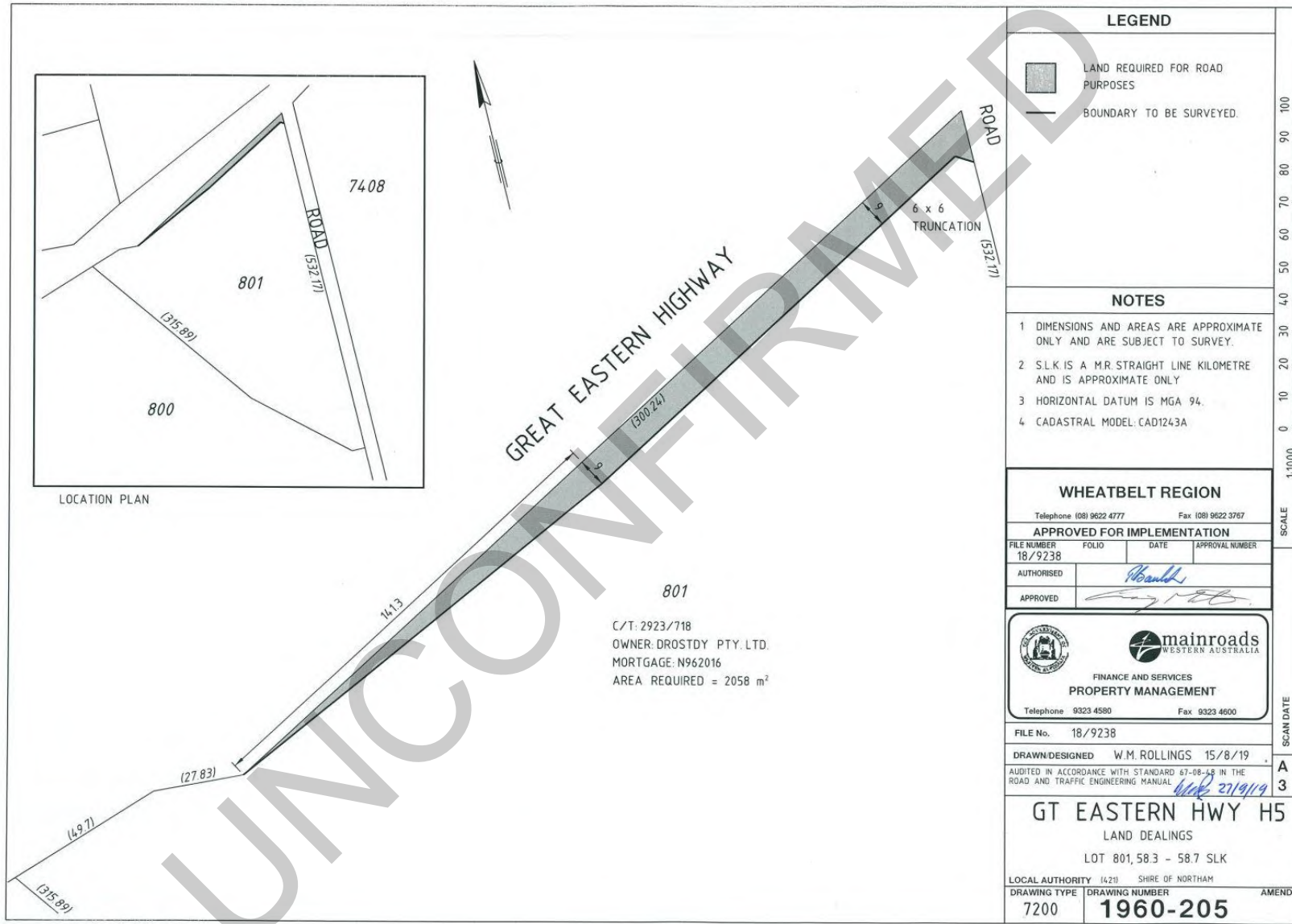

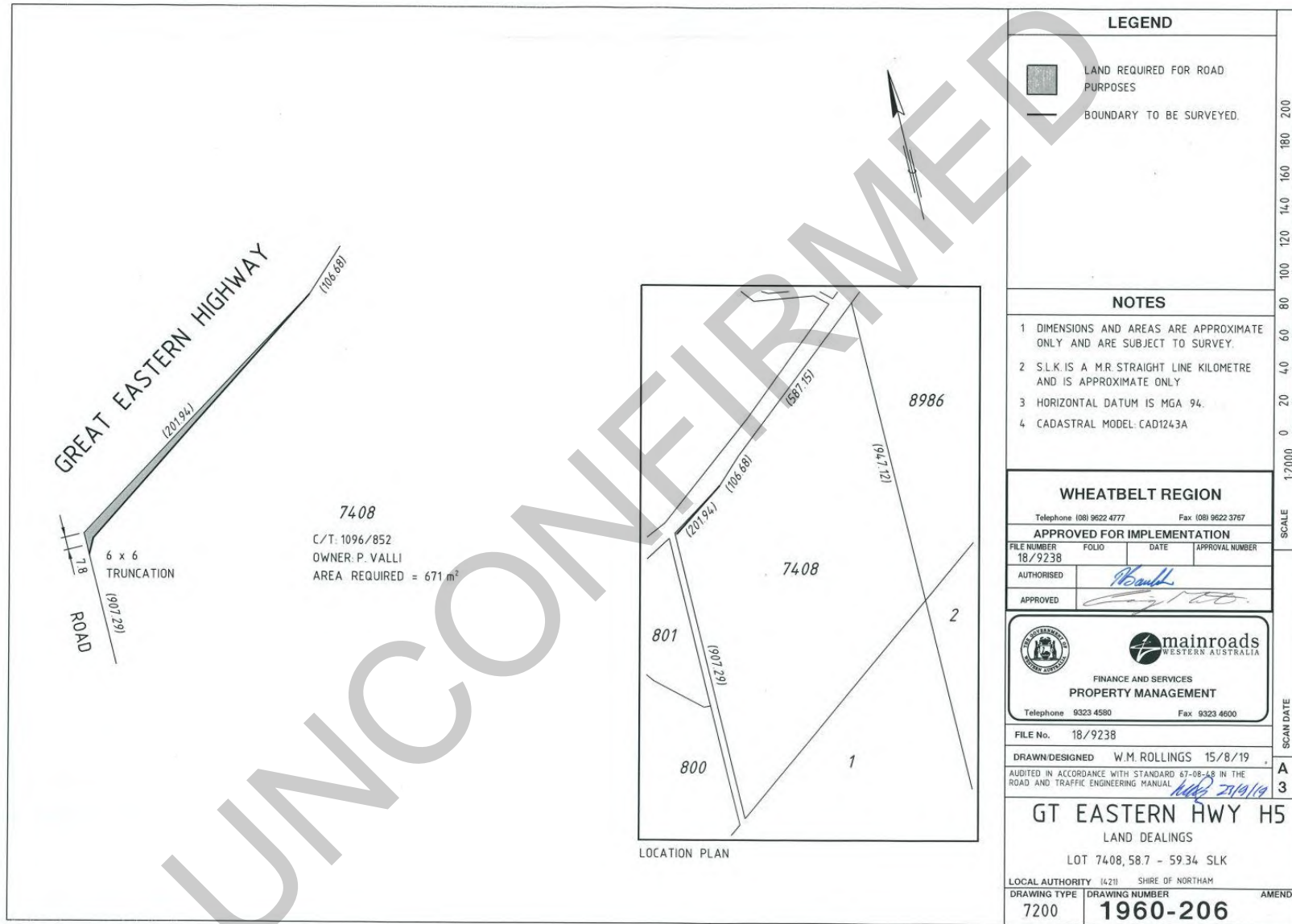

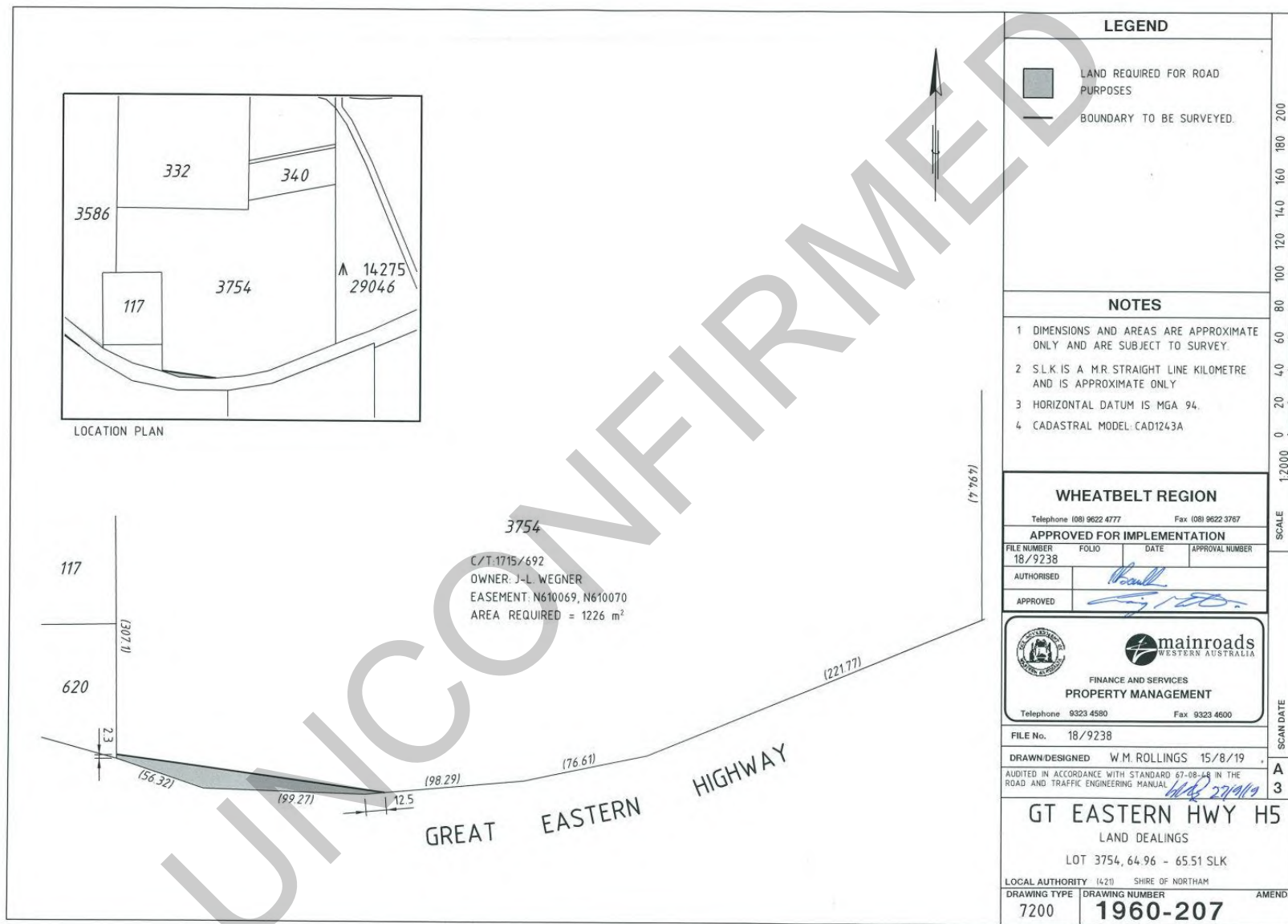

12.3.2 Environmental Protection Act 1986 Review – Consideration of WALGA'S submission

Address:	N/A
Owner:	N/A
Applicant:	Shire of Northam
File Reference:	7.2.1.6
Reporting Officer:	Jenny Abbott, Environmental Sustainability Officer
Responsible Officer:	Chadd Hunt, Executive Manager Development Services
Officer Declaration of Interest:	Nil
Voting Requirement:	Simple Majority
Press release to be issued:	No

BRIEF

The Department of Water and Environmental Regulation (DWER) has released a discussion paper outlining the proposed changes to the *Environmental Protection Act 1986* (EP Act).

As a response the Western Australian Local Government Association (WALGA) has produced a draft submission on behalf of local governments with a collective position regarding the proposed changes and Council is now requested to consider supporting the WALGA submission.

ATTACHMENTS

Attachment 1: WALGA Environmental Protection Act 1986 Amendments draft submission.

Attachment 2: DWER Modernising the Environmental Protection Act Discussion paper (39 pages).

A. BACKGROUND / DETAILS

The Environmental Protection Act is currently 33 years old and the State Government has determined its review and update necessary. The aim of modernising the Act is to improved regulatory efficiency and effectiveness, incorporating technological developments, removing ambiguity, streamlining processes and removing duplication and barriers within its application.

In response to the legislative review, WALGA has been proactive in assisting local governments by producing a draft submission that local governments

can choose to support and provide comment on. The WALGA submission discusses proposed changes to:

- New areas of reform – bilateral agreements, environmental covenants, environmental certification and power for injunctions.
- Environmental Protection Authority responsibilities
- Environmental Protection Policy
- Environmental Impact Assessment – referral and assessment of proposals, strategic assessment, proposal application processes, conditions, compliance and enforcement, schemes and cost recovery.
- Environmental regulation – clearing permits and licences.
- Enforcement and appeals.
- Schedule 6 exemptions.

Due to limited timing between WALGA releasing their draft submission and Council meeting dates in Dec 2019 and January 2020, the local comment period on the submission did not allow time for a significant council review prior to the January 6th 2020 submission deadline. It is proposed that in the interim Council considers supporting the draft WALGA submission and provide any additional concerns or comments later in an independent submission directly to DWER by the 28 January 2020 deadline.

B. CONSIDERATIONS

B.1 Strategic Community / Corporate Business Plan

Theme Area 4: Environment & Heritage.

Outcome 4.3: Residents and organisations within the Shire of Northam are supported to reduce their environmental impact.

Objective: Sustainable waste management with the aim of reducing and reusing waste effectively;

Outcome 4.4: Rivers and waterways in the Shire of Northam are greatly valued and maintained to a high natural standard.

Objective: The Shire of Northam is widely known and maintained as a biodiversity hotspot and the premier destination to experience the Avon River;

Theme Area 6: Governance & Leadership.

Outcome 6.4: The Elected Members of the Shire of Northam provide accountable, strong and effective community leadership.

Objective: Open, accountable and effective decision making.

B.2 Financial / Resource Implications

N/A.

B.3 Legislative Compliance

Shire of Northam and its residents are required to comply with the Environmental Protection Act 1986 and it is therefore relevant for the Shire of Northam to review any proposed changes in this legislation.

B.4 Policy Implications

N/A.

B.5 Stakeholder Engagement / Consultation

The previous council agenda shut on 2 December 2019, the WALGA draft submission reviewing the Environmental Protection Act was received by the Shire on 9 December 2019, not allowing for sufficient time to present to council and obtain a position.

B.6 Risk Implications

Risk Category	Description	Rating (consequence x likelihood)	Mitigation Action
Financial	Cost associated with user pays system such as obtaining a clearing permit for road widening.	moderate (8)	To review and comment on legislative changes with councils position.
Health & Safety	Nil	N/A	N/A
Reputation	Not contributing to legislative governance and being proactive in environmental management of the Shire	Moderate (9)	To review and comment on legislative changes with councils position.
Service Interruption	Nil	N/A	N/A
Compliance	Nil	N/A	N/A
Property	Nil	N/A	N/A
Environment	Potential loss of remnant vegetation and biodiversity.	High (15)	To review and comment if environmental regulation is inadequate.

C. OFFICER'S COMMENT

The proposed amendments will provide the required update of the EP Act by modernising terminology, incorporating technology for reporting and enforcement, whilst streamlining licensing and permit processes. This will potentially benefit the planning, health, engineering and environmental services within the Shire and industry that currently experience long delays

between submissions and approvals with tedious processes currently in place for minor changes and amendments.

The WALGA discussion paper raises the exemptions for 'permits to clear' native vegetation to include exemptions for line of sight clearing and clearing in narrow road reserves for local government. It also acknowledges issues for areas such as the Wheatbelt where extensive clearing has been undertaken which is known to be *'beyond the safe ecological limits'*.

Another significant issued raised by WALGA is the enforcement of the 'cost recovery' model that commenced on 1 July 2019. The model burdens local governments with the additional costs associated with obtaining permits and licences which will inevitably be passed on to the ratepayer. This model was brought in to be a 'user pays' system, however this burdens local government with increased costs associated with clearing permits for road widening projects that inevitably serve community purpose.

Further to above, WALGA also addresses issues with changes to the Environmental Protection Authority (EPA) assessment process where the EPA can chose to only 'part assess' proposals that fall under other legislation. Only the EP Act can facilitate assessments against key environmental factors and the cumulative impacts of proposals. The requirement of the EPA to provide reports against the EPA's objectives and how other Acts would facilitate this in addition to specifying conditions and the capacity for enforcement would ensure environmental values are captured.

In summary staff believe that the issues raised within the WALGA draft submission are valid and are supported. It is therefore recommended that Council support the WALGA submission.

RECOMMENDATION / COUNCIL DECISION

Minute No: C.3858

Moved: Cr Pollard

Seconded: Cr Della

That Council supports the draft submission developed by WALGA on behalf of local government regarding the proposed changes to be made to the *Environmental Protection Act 1986*.

CARRIED 10/0

Attachment 1



Environmental
Protection Act 1986
amendments

Submission

December 2019



Contact:

Nicole Matthews

Environment Policy Manager

WALGA

ONE70, LV 1, 170 Railway Parade West Leederville

Phone: (08) 9213 2039

Email: nmatthews@walga.asn.au

Website: www.walga.asn.au

UNCONFIRMED



Contents

1.0	About us	4
2.0	WALGA's comments	4
3.0	Comments on proposed amendments	5
3.1	New areas of environmental reform	5
3.2	Part II Environmental Protection Authority	7
3.3	Part III Environmental Protection Policies	7
3.4	Part IV Environmental Impact Assessment	7
3.5	Part V Environmental Regulation	10
3.6	Part VI Enforcement	13
3.7	Part VII Appeals	13
3.8	Schedule 6	13
4.0	Further recommendations for modernisation of the EP Act	13
4.1	Review of the EP Act	13
4.2	Principles of the EP Act	13
4.3	State of the Environment Reporting	14
4.4	Needs based approach for new landfills and waste infrastructure	14
4.5	Schemes	15
4.6	Appeals	16
4.7	Cumulative impact	16
4.8	Making data publicly available	16
5.0	Conclusion	17



1.0 About us

The Western Australian Local Government Association (WALGA) is the peak industry body for Local Government in Western Australia. WALGA is an independent, membership-based organisation representing and supporting the work and interests of 138 Local Governments in Western Australia.

WALGA provides an essential voice for approximately 1,222 Elected Members and approximately 22,000 Local Government employees as well as over 2.5 million constituents of Local Governments in Western Australia. WALGA also provides professional advice and offers services that provide financial benefits to the Local Governments and the communities they serve.

WALGA's governance structure is comprised of WALGA State Council, the decision making representative body of all Member Councils, responsible for sector-wide policy making and strategic planning on behalf of Local Government, and Zones, (5 metropolitan and 12 country), groups of geographically aligned Member Councils responsible for direct elections of State Councillors, providing input into policy formulation and providing advice on various matters.

2.0 WALGA's comments

WALGA welcomes the opportunity to comment on the Modernising the Environmental Protection Act Discussion Paper and Exposure draft Bill. [Local Governments have been consulted in the development of this submission and it has been endorsed by WALGA State Council.]

Local Governments have significant interactions with the *Environmental Protection Act 1986* (EP Act), in relation to their land use planning responsibilities and in their role as land owners and managers.

WALGA is a member of Department of Water and Environmental Regulation (DWER) Regulatory Reform Reference Group, the Environmental Protection Authority Stakeholder Reference Group, the Water Resources Reform Reference Group and the Local Government Roadside Clearing Regulation Working Group.

WALGA has previously commented on the need to examine the adequacy of the operation of the EP Act, including in submissions on matters that relate to the operation and effectiveness of the EP Act and Regulations, including on [proposed cost recovery for clearing permit applications and water licences](#), the [draft DWER Compliance and Enforcement Policy](#), the Strategic Assessment of the Perth and Peel regions and the review of the State Environmental Offsets Framework.

As a general comment, WALGA supports proposed amendments to the EP Act that will improve its regulatory efficiency and effectiveness, on the proviso that environmental outcomes are not negatively affected. In this context WALGA supports proposed amendments aimed at updating the operation of the Act to account for technological developments, clarification, changes to other related legislation, removal of anomalies and unnecessary



process/requirements and removing unreasonable barriers to effective compliance and enforcement. However WALGA considers that further consideration should be given to changes that could improve the effectiveness of the Act in achieving its purpose, object and principles (Part I s.4):

To protect the environment of the State, having regard to the following principles –

1. The precautionary principle
2. The principle of intergenerational equity
3. The principle of the conservation of biological diversity and ecological integrity
4. Principles related to improved valuation, pricing and incentive mechanisms
5. The principle of waste minimisation

The comments in this submission are therefore in two parts. The first relates to the amendments as proposed in Section 2 of the Discussion Paper. WALGA's comments on this section are restricted to those amendments of particular relevance to Local Government. The second part relates to the other matters WALGA considers should also be included in the Bill (some of which are contained in section 3 of the Discussion Paper) or be considered to improve the effectiveness of the EP Act to protect the environment.

To fully realise the benefits that could be delivered from a modernised EP Act, sufficient resources must be allocated to deliver the Department's regulatory functions, supported by investments in better information (including reinstating State of the Environment Reporting) and a more strategic approach to the management of Western Australia's unique biodiversity.

WALGA also notes that there are a number of reviews and other processes currently underway, the outcomes of which intersect with, and have the potential to impact on, the modernisation of the EP Act, including the second 10 year statutory review of the *Environment Protection and Biodiversity Conservation Act 1999* (EPBC Act) which commenced in October (comments on the discussion paper due in February 2020), the review of the State Offsets Framework and consultation on the management of native vegetation in Western Australia (including the development of a State Native Vegetation Policy).

3.0 Comments on proposed amendments

3.1 New areas of environmental reform

Bilateral Agreements

WALGA supports in-principle, proposed amendments to give effect to the operation of bilateral agreements, including for approvals, under Part 5 of the EPBC Act, recognising that such an agreement has the potential to reduce duplication and delay in the consideration of proposals. However such an agreement must ensure that environmental standards are



maintained, that is that approved actions do not have unacceptable or unsustainable impacts on matters of national environmental significance (MNES)¹.

Environmental Protection Covenants

WALGA supports the establishment of environmental protection covenants as a discrete mechanism under the EP Act.

Certification of environmental practitioners

WALGA acknowledges there have been long-standing issues with the standard of information submitted by some proponents under the EP Act and the EPBC Act. This issue was recognised in the 2009 review of the EPBC Act which recommended that:

...the Australian Government, in consultation with the environment and planning consulting industry, develop an industry Code of Conduct for consultants supplying information for the purposes of the environmental impact assessment and approval regime under the Act².

However WALGA does not consider a case for certification has yet been made and there is insufficient detail in the Discussion Paper about how such a scheme would work for WALGA to support the inclusion of a head of power at this time. For example it is unclear whether this would be a Government managed scheme, or one run by one or more professional bodies, what does it mean to have a document 'certified', whether a certification by an 'accredited person' would reduce the scrutiny of the regulator on the potential impacts of a proposal – i.e. contracting out responsibility of the regulator, or what the cost of such a scheme might be or where it would be borne.

It is also unclear why legislative change is required to facilitate a certification scheme.

WALGA considers there are a number of other measures that can be progressed to improve the standard of documentation submitted by proponents, including the provision of clearer guidance and consistent advice regarding the nature and standard of information required, continued investment in the collection and open access to information and data and the auditing and verification of information provided by proponents. Prompt rejection of poor applications should also occur to send a signal to proponents and environmental practitioners regarding required standards of information.

Whether a certification scheme goes ahead, and the nature of any such scheme is of particular relevance to the Local Government sector as employers of environmental practitioners, procurers of services from environmental practitioners and as proponents as well as WALGA's preferred supplier program, which includes environmental practitioners on its panels. As such

¹ [Standards for Accreditation of Environmental Approvals under the *Environment Protection and Biodiversity Conservation Act 1999*](#), Australian Government, Department of the Environment, 2014, p10

² [The Australian Environment Act – Report of the Independent Review of the *Environment Protection and Biodiversity Conservation Act 1999*](#), October 2009 Final Report, Australian Government Department of the Environment, Water, Heritage and the Arts, 2019, recommendation 24, p18



WALGA expects that the Local Government sector should be consulted on the design of any proposed accreditation scheme.

Expansion of power to apply for injunctions for a broader range of offences

WALGA supports amendments to broaden the range of circumstances (currently only for native vegetation clearing) in which the CEO can apply for an injunction for breaches of Part IV and V of the EP Act.

3.2 Part II Environmental Protection Authority

EPA Chairman either full or part-time

WALGA considers that the role of Chair of the EPA is a one with significant responsibilities and increasing complexity that should be performed on a full-time basis.

3.3 Part III Environmental Protection Policies

WALGA supports a review of the effectiveness of Environment Protection Policies under Part III of the EP Act.

3.4 Part IV Environmental Impact Assessment

Referral and assessment of proposals

WALGA supports proposed amendments to:

- Allow for a referred proposal to be withdrawn where a proponent does not wish to proceed;
- Allow for amendment of a proposal after referral but prior to a determination of a level of assessment;
- Clarify that the Minister may direct the EPA to assess or further assess a proposal more fully (based on new information, or failure to consider something in the original decision) or after the EPA has decided not to assess the proposal and the Minister, having determined an appeal has upheld the EPA decision;
- Provide the EPA with discretion to determine which decision-making authorities it will notify of its decision to assess a proposal (and are therefore constrained from making a decision which allows its implementation) rather than having to notify every government body connected to the proposal not matter how minor.

WALGA has concerns with the proposal that EPA can decide not to assess all or part of a proposal where the impact on a key environmental factor can be adequately regulated under other parts of the EP Act or other written laws. It is only the EP Act that facilitates assessments against objectives for key environmental factors and scope for assessing cumulative impacts of proposals. Provisions in other processes like licencing or conditions on land use change proposals are designed to protect listed matters and do not adequately assess the impacts on environmental factors as a whole.



In this context WALGA considers that in this case the EPA should be required to:

1. Provide a report on their assessment of the proposal against EPA's objectives and how meeting the other Acts provisions would facilitate this; and
2. Specify what conditions be put on the proposal, considering the capacity for enforcement.

Strategic Assessments

WALGA supports the use of strategic assessments as a way of achieving better development and environmental outcomes. WALGA has made previous submissions on this matter in relation to the Green Growth Plan and review of the Strategic Assessment of the Perth and Peel Regions.

WALGA supports the clarification provided for in the proposed amendments that bring the terminology in line with that in other jurisdictions.

Surrender of revocation of Implementation Agreement

WALGA supports providing for the expiry, withdrawal or revocation of an implementation agreement.

Implementation decisions for proposals

WALGA supports all proposed amendments in the Bill that provide the Minister with discretion to restrict consultation to and reach agreement with those decision-making authorities relevant to the proposal and its environmental impacts, rather than all decision-making authorities.

Conditions

Providing clarity on the types of implementation conditions that can be imposed by the Minister is supported.

An expansion of minor changes that the Minister may make to implementation conditions after an implementation statement has been issued to a proponent is supported.

Imposing conditions allowing for staffed implementation of a proposal is also supported.

Changed proposals and revised proposals

WALGA supports proposed amendments to s. 45C to enable the Minister to require information when a proponent makes a request to change a proposal.

The proposal to streamline the process for amending a proposal during assessment and clarification of the process for referral and assessment of a significant amendment and that the proposed changes are to be assessed in the context of the entire project are also supported.



Compliance and enforcement

All proposed amendments are supported.

Schemes

WALGA agrees that the EPA should be able to extend the time to decide whether to assess a scheme or determine that it is incapable of being made environmentally acceptable beyond the existing 28 days when it has not been provided with sufficient information to make a decision and further information has been sought. It is noted that this is in line with the process for other proposals. To minimise delays WALGA considers that the EPA's request for additional information should be made as soon as possible after the scheme has been referred.

Providing for an agreement or decision between the Minister for the Environment and the Minister for Planning that a scheme may not be implemented is also supported.

Further comments regarding schemes are contained in section 4.

Cost recovery

WALGA does not support the imposition of cost recovery on Local Governments, as stated in its November 2018 [submission to the Department of Water and Environmental Regulation's Discussion Paper on Cost Recovery](#).

In that Discussion Paper the imposition of fees proposed was premised on the application of the user-pays principle:

'...the full or partial cost of service of regulatory activities should be borne by those who benefit most from the service.'

The Discussion Paper continued:

'Currently the cost of assessing applications for native vegetation clearing permits and water licences and permits is primarily borne by the taxpayer, not the applicants who derive the benefit.'

WALGA agrees with the user-pays principle and considers cost recovery may be appropriate in an efficient system where there is a private benefit accruing to, in this case, the applicant for a permit or licence. However WALGA argues strongly that the activities undertaken by Local Governments for which approvals, permits or licences are required are almost entirely for public benefit, are often non-discretionary (eg for improving road safety) and that these benefits often extend beyond their local communities. This therefore amounts to cost shifting from one level of government to another.

Compounding this issue is the inability for most Local Governments to absorb additional costs without raising rates, this means a reduction in funds available to spend elsewhere or ratepayers paying more.



3.5 Part V Environmental Regulation

Clarifying when decisions on applications for clearing permits or licences are constrained

WALGA supports clarification of the intent that the CEO may not make a decision on a clearing permit or licence application that will have the effect of leading the proposal that has been referred to the EPA under s. 38 down the road of implementation in potential contradiction of the advice of the EPA or the decision of the Minister.

Clearing of native vegetation

As previously stated, WALGA supports proposed amendments to the EP Act that improve administrative efficiency without negatively affecting environmental outcomes. In this context WALGA notes that the current clearing permit system is cumbersome, inefficient and complex. DWER's performance in meeting the target of assessing clearing permit applications within 60 business days is poor, with only 49 per cent within this timeframe in 2018-19.

Efficient and effective clearing regulation is important to the Local Governments, which as a sector represents a significant proportion of all clearing permit applications, second only to the State Government. Over the period 2016-17 to 2017-18, Local Governments submitted approximately 250 clearing permit applications. In 2017-18, 23 per cent of all clearing permit applications were submitted by Local Governments. Almost all Local Government clearing permit applications since 2016-17 have been for clearing of areas of less than 10 ha.

Local Government frustration with the regulatory requirements for their activities requiring a native vegetation clearing permit are reflected in on-going requests for changes to the regulatory system. Via WALGA's Zone and State Council representation, Local Governments have requested changes to the native vegetation clearing regulations, including calling for:

- Exemptions for Local Government services (State Council resolution 2012 & 2017);
- Amendments to exemptions relating to clearing in road reserves, ranging from specific changes to clearing to improve sightlines to overall exemptions within narrow road reserves (20m wide) (via Regional Road Groups or direct representation to WALGA in 2017-2019);
- Intervention in the system to prevent vexatious appeals which can result in significant delays in road works delivery dependent on time specific grant funding requirements;
- A review of conditions put on clearing permits, due to impacts on timeframes for the deliverer of road projects (Zone resolution 2018);
- Clarity around the application of clearing exemptions (numerous requests for clarification via WALGA due to inadequate responses from DWER staff).

More efficient regulation is only one part of a more comprehensive approach to the management of native vegetation that is needed in Western Australia. WALGA has been strongly [advocating for such an approach to be developed and implemented](#), noting in particular the findings of the Western Australian Auditor General, referencing the last State of the Environment Report 2007:



'In some parts of WA (especially the Wheatbelt and parts of the Swan Coastal Plain) native vegetation has been cleared beyond safe ecological limits. Continued clearing will result in loss of biodiversity and extinctions, with fragmented habitats becoming more susceptible to climate change, disease, and weed and introduced animal invasion.'

The DWER Cost Recovery Discussion Paper, coming more than 10 years after the State of the Environment and Auditor General's report made the same comment (p6). In addition to illustrating the need for ongoing State of the Environment Reporting, WALGA considers that the acknowledgement by DWER that ecological limits of clearing have been exceeded in the Wheatbelt and the Swan Coastal Plain requires consideration by the State Government of a strategic, comprehensive and sustainably funded approach to the protection of native vegetation, of which clearing regulation is only one part.

In this context WALGA welcomes the Government's commitment to develop a Native Vegetation Policy for Western Australia, improved mapping and monitoring of native vegetation, strategic regional conservation planning and better regulation.

Declaration of Environmentally Sensitive Areas

Prescribing Environmentally Sensitive Areas (ESAs) in regulations is supported as a means of keeping ESA's current. The current ESA notice was gazetted in 2005 and it is generally accepted that the existing requirements in s. 51B have mitigated against updating. However WALGA considers that the requirement for the Minister to consult with relevant parties on significant changes to ESAs is important and that this should be included in the proposed new s. 51B.

Referral process for clearing permits

WALGA strongly supports the introduction of a referral process for clearing for which an exemption does not apply but may not have a significant effect on the environment, as this will lead to improvements in the ability of Local Governments to implement their road projects in an efficient and effective manner.

Licences

WALGA commends the significant changes proposed to the licencing system and considers that they will address the significant gaps in the current regulatory framework. However, WALGA notes that these new requirements will require substantial additional staffing for the Department and streamlined and efficient processes for licence applications.

The current licencing approach does not require a prescribed premises to have a licence, instead a licence is a protection against prosecution. In WALGA's Submission on the DWER Compliance and Enforcement Framework, WALGA highlighted the limitations of the current situation and supported a licence being required to undertake Schedule 1 activities.

In particular WALGA welcomes the licencing of the activity rather than the premises, so there will be 'prescribed activities' rather than 'prescribed premises'. This will provide more flexibility



for proponents and enable more than one licence on a site (for example if two operators share the same premises). The ability to determine an area for the activity will remain. Other amendments will allow additional flexibility in relation to who can hold the licence, currently this is restricted to the 'occupier' of the site.

WALGA supports the move to an occupier of a premises being required to hold a licence if undertaking an activity which falls under Schedule 1 of the EP Act. Currently there is no express requirement for an occupier to hold a licence. WALGA also supports the introduction of a new penalty for carrying out a prescribed activity without holding the relevant licence. For this amendment to be effectively implemented the Department will need to have in place a plan and sufficient resources to identify and licence these activities.

The Discussion Paper flags the need for consequential amendments to Schedule 1 of the EP Act Regulations. This could potentially have a significant impact on Local Government, particularly the landfill classifications. DWER has previously proposed to reduce the number of landfill categories which would potentially mean landfills which are currently only regulated, would need to be licenced. WALGA recommends further engagement with the sector and with industry in the review and revision of Schedule 1 of the EP Act Regulations, covering prescribed activities.

WALGA also recommends that guidelines or environmental standards for each category of activity in Schedule 1 need to be developed in consultation with industry to provide certainty to industry regarding the requirements for their type of prescribed activity and to ensure a transparent approach to how DWER will assess different facilities. Without this documentation there is likely to be considerable concern from Local Government that a one size fits all approach to regulation will be used.

WALGA supports an opt-in system for persons undertaking prescribed activities not meeting the threshold. This change is supported as it has the ability to encourage better practice approaches by smaller operators, it also allows for a smoother transition from unlicensed to licensed operators as an operations increases in size.

Provisions to include liability for persons other than the licensee, requiring an employee or a contractor to comply with licence conditions and potentially be liable for breach of conditions (depending on the circumstance) is supported.

Combining works approvals and licences into one instrument which would regulate both the works and the prescribed activity is also supported.

WALGA also supports changes to allow for the revocation or suspension of a licence for non-payment of prescribed fees and that DWER can give a closure notice in this instance.

Defences

WALGA supports the provision of a defence for clearing in an ESA to prevent imminent danger but recommends that clear guidance be developed to ensure that this provision is understood.



3.6 Part VI Enforcement

WALGA supports all proposed amendments to Part VI.

3.7 Part VII Appeals

WALGA supports all proposed amendments in relation to the appeals process. Further recommendations regarding appeals are contained at section 4.

3.8 Schedule 6

WALGA welcomes the clarification provided by the proposed amendments to Schedule 6 regarding clearing for which a clearing permit is not required, in particular in relation to comply with a notice given under s. 33(1) of the *Bush Fires Act 1954*, clearing that is done by the owner or occupier of land to comply with a notice issued by a Local Government under the *Local Government Act 1995* or by the Local Government if the owner or occupier does not comply with the notice.

4.0 Further recommendations for modernisation of the EP Act

4.1 Review of the EP Act

While WALGA supports most of the proposed amendments to the EP Act, it is noted that these are overwhelmingly related to the efficiency of the Act's operations, not its effectiveness in achieving its objective to protect Western Australia's environment. In this context WALGA notes that the current EP Act has been operational for 32 years (and the previous EP Act was in place for 15 years) and that scientific understanding of the environment, threats to the environment, including the impacts of climate change and approaches to regulation and environmental impact assessment have changed markedly over that time. WALGA considers that the focus only on efficiency and streamlining is a missed opportunity to consider the 'how' to best achieve environmental protection.

WALGA recommends a thorough independent review be undertaken to ensure that Western Australia's environmental legislation able to effectively address contemporary and interrelated challenges of biodiversity protection, natural resource management, land use, human settlements, production and consumption systems and climate change.

WALGA also recommends that there be a statutory requirement for the EP Act to be independently reviewed every 10 years.

4.2 Principles of the EP Act

WALGA recommends that consideration be given to adding two additional principles to s. 4A of the EP Act in relation to:

1. Climate Change: that climate change mitigation and adaption should be a fundamental consideration.



2. Advice and decision making will be evidence based, using the best available scientific knowledge.

4.3 State of the Environment Reporting

State of the Environment (SOE) reporting synthesises environmental data and information to communicate credible, timely and accessible information about the condition of the environment to decision makers and the community. Western Australian State of the Environment reporting has not been undertaken since 2007.

WALGA considers that a requirement for the EPA to produce a Western Australian SOE report at least every 5 years should be included in the EP Act, along with the requirement for an SOE Report to be tabled in Parliament.

4.4 Needs based approach for new landfills and waste infrastructure

In the Waste Avoidance and Resource Recovery Strategy 2030, Action 45 is to 'Investigate options for developing a 'needs based' approach to the approval of new landfills and other waste infrastructure'.

When the *Waste Avoidance and Resource Recovery Act 2007* was reviewed in December 2014, the Background Paper identified that existing landfills had capacity for the waste being generated until around 2025, or until 2030 if the targets in the Waste Strategy were met. The Paper also identified that there was 'increasing pressure for metropolitan waste to be disposed to landfill outside the metropolitan area'.

The Paper stated:

'There is a strong case to reform the landfill policy and regulatory framework to include planning, siting and compliance considerations so that landfills can be managed consistent with government policy. Policy considerations should balance the need to ensure availability of sufficient landfill space to manage residual waste and unplanned events...with the need to limit supply to encourage maximum diversion from landfill'³.

WALGA agrees with this assessment.

This policy gap has not been addressed in the years since the Background Paper was released, and non-metropolitan Local Governments continue to raise this important issue with the Association. Instead of limiting the number of landfills to support the diversion targets in the Strategy, the State's regulatory framework currently allows landfills to be assessed on a case by case basis, only considering whether the environmental impacts at each site are acceptable. This lack of a strategic approach is likely to result in more landfills, greater

³ *Review of Waste Avoidance and Resource Recovery Act 2007 Discussion Paper*, Department of Environment Regulation, 2015.



competition between sites, lower landfill prices and ultimately, undermine the landfill diversion targets in the State Waste Strategy.

WALGA acknowledges the need for appropriately planned landfills in the future, but would highlight that there is more than sufficient landfill space for the foreseeable future and asserts that the policy relating to landfills needs to change to ensure the need for a site is demonstrated before it is approved.

WALGA recommends that the EP Act be amended to ensure that the CEO can refuse a license application if a proposed facility will undermine Waste Avoidance and Resource Recovery Strategy outcomes and targets. This could be included in s. 54 of the EP Act under matters the CEO must have regard to.

4.5 Schemes

The Planning and Development Act 2005 (P&D Act) currently requires all planning schemes and amendments to planning schemes to be referred to the EPA for determination as to whether an assessment is required. This requirements applies for both region and local planning schemes.

With the decision in 2015 to create a tiered system of local planning scheme amendments there is an opportunity to alter S. 81 of the P&D Act to remove or reduce the regulatory burden of formal referrals to the EPA on scheme amendments where the amendment is 'basic', or where the amendment is 'standard' or 'complex' and there is no likelihood that the amendment will materially impact on the environment.

The proposal above has two parts:

- The removal of the need to refer 'basic' amendments to the EPA in all situations.

Such a requirement would require modifications to the P&D act and possibly the Planning and Development (Local Planning Scheme) Regulations 2015 (LPS Regs), but would unlikely require modifications to S. 48A of the EP Act as basic amendment would no longer require referral.

WALGA's support for this change stems from the fact that 'basic' amendments are largely administrative in nature, and unable to be classified as 'basic' where they are inconsistent with the Scheme, a Local Planning Strategy, or a State Planning Policy. Thus the likelihood of a 'basic' amendment meeting the threshold of assessment under S. 48A(b) or being incapable of being made environmentally acceptable under S. 48A(c) the EP Act is extremely low.

- The possibility of removing or reducing the regulatory burden of referrals for 'standard' and 'complex' amendments where there is no likelihood that the amendment will materially impact on the environment.

The meanings for both 'standard' and 'complex' amendments as provided for in R. 34 of the LPS Regs include a number of descriptions that are either administrative in



nature or relate to matters that would no likely involve the need to consider the environmental impact of the proposal. An example of this would be point (e) of the 'Complex' amendment definition, this requires all proposals for a development contribution scheme or amendment to such a scheme to be considered as a 'complex' amendment. In this example the amendment could be as simple as amending a cost schedule or altering the administrative requirements in the cost schedule, both of which would pose no risk to the environment of the Scheme area of the wider environment.

The Association does not propose a blanket removal of the referral requirement under S. 81 of the P&D Act for 'standard' and 'complex' amendments. Instead, a streamlined 'referral' process for such proposals is suggested. Where a Local Government has determined to adopt or prepare an amendment, and that amendment is determined to be 'complex' or 'standard', it is proposed to allow the Local Government to make an initial assessment on whether a formal referral is require or not. On making such a decision the Local Government would then forward this to the EPA. The EPA would have a period of time (~14 days) to determine if this is the appropriate decision. Should the EPA determine that a formal referral is required then the Local Government would refer the amendment in line with the current requirements of S.48A of the EP Act and S. 81 of the P&D Act.

It is assumed that should this proposal be accepted that the EPA and the WAPC would issue guidance on how a Local Government would exercise its discretion on 'standard' and 'complex' amendments and the matters it should consider in making such a decision to ensure consistent decision making.

The principles applied above could also be applied to 'minor' amendments to region planning schemes where the likelihood of environmental impact is low.

Such changes would greatly reduce the regulatory burden of the EPA in reviewing and responding to the large number of scheme amendments processed each year that are unlikely to reach the threshold of requiring environmental review. This would also reduce timeframes for the processing of scheme amendments, particularly 'basic' amendments.

4.6 Appeals

WALGA considers that there should be statutory timeframes introduced for the appeals process and that a report on the appeal should be provided to the Minister within 60 days.

4.7 Cumulative impact

WALGA considers that the need to consider cumulative environmental impacts should be incorporated throughout the EP Act.

4.8 Making data publicly available

WALGA has strongly supported the State Government's initiative to develop the Index of Biodiversity Surveys for Assessments (IBSA) as a means of capturing and consolidating data



contained in biodiversity survey reports to support assessments and compliance under the EP Act and making this information publicly available.

Currently there is no requirement for the intellectual property holder to agree to make their data public.

WALGA recommends that consideration be given to making such a requirement mandatory subject to specific exemptions.

5.0 Conclusion

WALGA appreciates the opportunity to comment on the Discussion Paper and draft *Environmental Protection Amendment Bill 2019* and acknowledges a number of the proposed changes to the EP Act in relation of licencing and clearing permits have the potential to improve environmental regulation in Western Australia.

However, WALGA asserts that the relatively narrow scope of amendments proposed represents a missed opportunity to look holistically at the EP Act (and related legislation) to ensure they are fit-for-purpose in protecting Western Australia's unique environment.

Attachment 2



Government of Western Australia
Department of Water and Environmental Regulation

Modernising the *Environmental Protection Act*

Discussion paper

October 2019



Modernising the *Environmental Protection Act*

Discussion paper

Department of Water and Environmental Regulation
October 2019

Department of Water and Environmental Regulation
Prime House, 8 Davidson Terrace
Joondalup Western Australia 6027
Locked Bag 10 Joondalup DC WA 6919

Phone: 08 6364 7000
Fax: 08 6364 7001
National Relay Service 13 36 77

dwer.wa.gov.au

© Government of Western Australia

October 2019

This work is copyright. You may download, display, print and reproduce this material in unaltered form only (retaining this notice) for your personal, non-commercial use or use within your organisation. Apart from any use as permitted under the *Copyright Act 1968*, all other rights are reserved. Requests and inquiries concerning reproduction and rights should be addressed to the Department of Water and Environmental Regulation.

FIRST 115778

Acknowledgements

Cover photograph: Amy Wyld

Disclaimer

This document has been published by the Department of Water and Environmental Regulation. Any representation, statement, opinion or advice expressed or implied in this publication is made in good faith and on the basis that the Department of Water and Environmental Regulation and its employees are not liable for any damage or loss whatsoever which may occur as a result of action taken or not taken, as the case may be in respect of any representation, statement, opinion or advice referred to herein. Professional advice should be obtained before applying the information contained in this document to particular circumstances.

This publication is available at our website www.dwer.wa.gov.au or for those with special needs it can be made available in alternative formats such as audio, large print, or Braille.

Contents

Foreword	1
1 Introduction	2
1.1 Background	2
1.2 Policy drivers	3
1.3 Why the legislation needs to be reformed	4
1.4 How were the proposed amendments developed?	4
1.5 How to use this discussion paper	5
2 Key areas of reform in the <i>Environmental Protection Act 1986</i>	6
2.1 New areas of environmental reform	6
2.2 Improvements to administrative efficiency	9
2.3 Part I – Preliminary	9
2.4 Part II - Environmental Protection Authority	9
2.5 Part III – Environmental Protection Policies	10
2.6 Part IV - Environmental Impact Assessment	11
2.7 Part V – Environmental Regulation	16
2.8 Part VI – Enforcement (page 231)	21
2.9 Part VIA- Legal Proceedings and Penalties (page 251)	23
2.10 Part VII – Appeals (page 272)	24
2.11 Part VIII – General (page 302)	25
2.12 Schedule 1 (page 336)	25
2.13 Schedule 5 (page 358)	26
2.14 Schedule 6 (page 360)	26
3 Further issues for consideration	27
3.1 New ideas	27
3.2 Delegations	27
3.3 Role of the Environmental Protection Authority	27
3.4 Environmental Protection Policies	28
3.5 Assessment	28
3.6 Decision-making	28
3.7 Offsets	29
3.8 Clearing of native vegetation	30
3.9 Industry regulation	30
3.10 Compliance and enforcement	30
3.11 Appeals	30
4 Having your say	31
4.1 How to provide feedback	31
4.2 Your legal rights and responsibilities	31

Foreword



Western Australia is home to some of the world's most biologically diverse flora and fauna as well as some of the world's most significant natural resources. For this reason, finding a balance between delivering on the full economic potential of our resources and the protection of human health and the environment is vital.

It is essential that our precious environment is protected for current and future generations and that environmental legislation works efficiently to support a sustainable economy.

The Department of Water and Environmental Regulation was established to create a 'one stop shop' for industry and developers with the aim of streamlining and simplifying Western Australia's water and environmental regulation. This process is ongoing and the modernisation of the *Environmental Protection Act 1986* (EP Act) is integral to this work.

Modernising Western Australia's environmental protection legislation supports this objective and promotes best practice on environmental protection and sustainable development.

The amendments outlined in this discussion paper focus on environmental impact assessment, environmental regulation and clearing of native vegetation regulated under the EP Act. The proposed amendments are drawn from a number of reviews undertaken since the last major amendments by the Gallop Government in 2003 and from feedback from stakeholders over that same period.

The intent of this paper is to promote discussion, invite feedback and encourage stakeholder involvement to support the modernisation of the EP Act.

I encourage you to carefully consider the proposed changes to this critically important legislation and provide your comments during the submission period.

I am confident that after broad and open consultation the amendments will be brought to the Parliament and will lead to more effective environmental legislation and ensure sustainable development can occur for the benefit of all Western Australians.

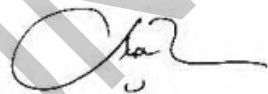

Hon Stephen Dawson MLC
Minister for Environment

1 Introduction

The *Environmental Protection Act 1986* (EP Act) was introduced over 30 years ago, and has been effective in providing a framework for protecting the environment and ensuring that the impacts of significant proposals are assessed and managed.

It is now timely to ensure that the EP Act is prepared for future challenges and continues to meet the expectations of the community and industry in protecting the environment and promoting sustainable development.

1.1 Background

The Environmental Protection Authority (EPA) and the Department of Environmental Protection were both established by the *Environmental Protection Act 1971*. This was the first time that Western Australia had a specific department and independent authority with powers to:

- take positive action to control environmental degradation;
- establish environmental protection policies that set acceptable standards for present and for the future;
- invoke public opinion as and when necessary;
- provide avenues of appeal in appropriate cases.

These powers, along with the establishment of the EPA, remain the cornerstones of the current EP Act.

The 1986 EP Act repealed the 1971 EP Act, as well as a number of other statutes dealing with pollution control, and consolidated regulation of pollution in the new Act. A number of the provisions of the 1971 Act were not implemented, particularly the provisions allowing for the declaration of environmental protection policies and the control of waste. The 1986 Act was intended to address the legal impediments to these. The 1986 Act also formalised the need for and requirements of environmental impact assessment, and the role of the EPA and Minister in assessment and decision-making. The second reading speech noted the retention of the EPA's functions to oversee and coordinate investigations, and provide independent advice on the protection and conservation of the environment.

While there have been a number of amendments to the EP Act since 1986, major changes include:

- the separation and clarification of the roles of CEO and Chairman of the EPA in 1993;
- the introduction of procedures aimed at bringing together planning and environmental assessment at an early stage of the development process in 1996;
- the introduction of provisions relating to legal proceedings and penalties in 1998;
- the introduction of provisions to regulate the clearing of native vegetation in 2003 and to create the offence of material or serious environmental harm.

It is timely to review the legislation, taking into account a number of government reviews that have been conducted and feedback from Ministers and stakeholders on its operation.

An Exposure draft Bill has been prepared for discussion and to invite feedback. Additional issues are also outlined in this paper for broader consultation.

1.2 Policy drivers

The McGowan Government's Service Priority Review was established in 2017 to drive reform of service delivery, accountability and efficiency of the Western Australian public sector. The proposed amendments to the EP Act specifically address the Service Priority Review's four directions for reform. These include:

- building a public sector focused on community needs - putting issues of community priority at the forefront of everything the public sector does.
- enabling the public sector to do its job better - overhauling internal systems to allow the sector to carry out work more efficiently and in the public interest.
- reshaping and strengthening the public sector workforce - embedding better workforce practices to support a more agile and innovative sector.
- strengthening leadership across government - applying stewardship and continuous improvement to get the best performance out of agency heads and central agencies.

The amendments in the Exposure draft Bill will support these directions by:

- ensuring that community expectations for a healthy environment are promoted and achieved;
- driving reform of processes and approaches to the regulation of the environment to promote more efficient practices;
- modernising the EP Act, improving the consistency and flexibility of legislative settings, and enabling the Department of Water and Environmental Regulation (DWER) to deliver more efficient services to business;
- improving regulatory processes under Parts IV and V, thereby supporting investment, employment and business creation in the State and good environmental outcomes; and
- assisting budget repair by providing for cost recovery of environmental impact assessment and services provided by the State Government on behalf of the Commonwealth Government through bilateral agreements.

The proposed amendments:

- modernise and streamline processes for environmental impact assessment, clearing permits, works approvals and licences;
- improve regulatory effectiveness; update the EP Act to reflect and accommodate technological developments;
- facilitate the implementation of bilateral assessment and approval agreements under the *Environment Protection and Biodiversity Conservation Act 1999* (EPBC Act), and address errors and inconsistencies.

1.3 Why the legislation needs to be reformed

The EP Act amendments outlined in this discussion paper address issues raised by a number of reviews since 2006.

Office of Development Approvals Coordination Working Group

The Office of Development Approvals Coordination established a working group, which included the Conservation Council of WA, WWF-Australia, Chamber of Minerals and Energy, Association of Mining and Exploration Companies, Australian Petroleum Production and Exploration Association, Department of Industry and Resources and Department of Environment and Conservation. The review proposed a number of principles for reform (with a focus on clearing provisions and the resources sector) and reported to the then Environment Minister in 2006.

Native Vegetation Clearing Review Committee

In July 2008, an expert committee chaired by Associate Professor Garry Middle, was established to review the native vegetation clearing provisions under the EP Act, which considered government outcomes for native vegetation protection, and suggested amendments to the EP Act, regulations and policies to improve the effectiveness and efficiency of clearing regulation. The committee reported to the Minister for Environment in April 2009.

Industry Working Group - review of approvals processes in Western Australia

An Industry Working Group chaired by Mr Peter Jones was established by the Minister for Mines and Petroleum in November 2008 to provide strategic advice on improving the credibility and efficiency of Western Australia's mining and petroleum approvals. It provided its final report to the Minister for Mines and Petroleum in April 2009.

Environmental Stakeholder Advisory Group on approvals process reform

An Environmental Stakeholder Advisory Group chaired by Dr Bernard Bowen was established in June 2009 to provide advice to the Minister for Environment on more efficient and coordinated assessment and decision-making for development approvals, with better environmental outcomes. The Advisory Group included representatives from industry, conservation and community groups, Murdoch University, and the Western Australian Local Government Association. The report was provided to the Minister in December 2009.

1.4 How were the proposed amendments developed?

The proposed amendments were developed after consideration of the outcomes of the reviews described above and internal reviews based on the outcome of appeals, court outcomes and advice that has been received by the DWER.

Key industry, conservation, government and community stakeholders were consulted as part of previous legislative reviews relating to environmental regulation, including the expert committee chaired by Associate Professor Garry Middle, the Environmental Stakeholder Advisory Group, and a Native Vegetation Government

Modernising the Environmental Protection Act

Agency Working Group which considered legislative amendments proposed in submissions to the Middle Review.

Draft bilateral assessment and approval agreements under the *Environment Protection and Biodiversity Conservation Act 1999* (EPBC Act) were released for public consultation in 2014. An assessment bilateral agreement commenced on 1 January 2015.

1.5 How to use this discussion paper

The paper is organised to focus on the key themes of the Bill, explaining the intent of the reforms and highlighting areas which consultation has shown to be of particular interest to stakeholders.

It generally follows the scheme of the EP Act and the Exposure draft Bill. The Exposure draft Bill is the version of the EP Act that would be in place if the amendments were passed by Parliament with amendments shown in track changes. This has been done to make it easier to understand the effect of the Bill on the EP Act.

The discussion paper does not include details of changes made in the Bill where these are minor corrections, improvements in wording or consequential amendments.

The discussion paper also discusses issues raised by stakeholders which require more open input and where drafting has not been completed. This is intended to allow for more open consideration of the policy issues for potential inclusions in the Bill to be considered by Parliament.

2 Key areas of reform in the *Environmental Protection Act 1986*

2.1 New areas of environmental reform

Bilateral Agreements with the Commonwealth (page 312)

Western Australia has a bilateral agreement with the Commonwealth of Australia to undertake bilateral assessments under the Commonwealth *Environment Protection and Biodiversity and Conservation Act 1999* (EPBC Act). The EPBC Act also provides for approvals bilateral agreements.

Bilateral agreements provide for an efficient, timely and effective process for environmental assessment and approval of the Commonwealth's controlled actions. They remove duplication of assessment and approval processes of the Commonwealth and WA while maintaining high environmental standards.

Amendments to the EP Act will ensure the State Government's ability to fully implement bilateral agreements, including providing that it is a function of not only the EPA, but also the Minister for Environment and the CEO of the Department, to promote the implementation of a bilateral agreement, or to take into account any guidelines or policies established under a bilateral agreement.

Amendments will ensure that the Minister for Environment and the CEO, in exercising their powers and functions in relation to the assessment of proposals and schemes, clearing permit applications and appeals, may exercise those powers and functions in a manner that is consistent with, and enables the implementation of bilateral agreements under the EPBC Act.

Amendments will also allow fees to be lawfully charged for work necessary for the purposes of discharging any additional obligations of the CEO as part of bilateral agreements in connection with clearing permit processes. It will also enable fees to be charged under Part IV of the EP Act for undertaking duties including processing referrals, undertaking assessments and approving management plans prepared as a condition of approval.

Overall, the amendments in relation to bilateral agreements are expected to have a positive benefit to business, consumers and the economy by removing duplication of Commonwealth and State Government environmental assessments and approvals.

Modernise requirements for advertising, publishing and confidentiality (various sections)

The EP Act currently imposes a variety of publication or advertising requirements in relation to different documents under various provisions of the Act.

To ensure consistency between the advertising and publishing requirements of the EP Act, uniform language is proposed when referring to advertising or publishing requirements (i.e. refer uniformly to a requirement to 'publish' rather than 'advertise' and the requirement to publish in a prescribed manner).

Consistent publishing requirements are also extended to a broader range of provisions under Part IV and V. These amendments are in line with modern publishing practices, reflecting changes in technology, and providing for the use of alternate means of publishing, such as the internet, and promoting accountability and transparency.

A provision is also proposed to allow regulations to prescribe further types of information and documents that must be published, or may be published on a case-by-case basis. This may include reports and information submitted for compliance purposes (e.g. under licence conditions, implementation statements and environmental protection covenants).

It is intended that a consistent approach to confidentiality, and exceptions to publication requirements, will be adopted throughout the EP Act. It is intended that the confidentiality test under section 39 in relation to Part IV proposals is removed and that criteria that will apply to the entire Act, and the process for making confidentiality claims, may be prescribed in regulations.

The Act may need to provide that the obligation to publish particular documents, material or information is subject to any exception prescribed in the regulations. The regulations will prescribe a process for making a request that information is not to be published, how such a request is dealt with, and any criteria to be adopted in determining whether an exception from the general publication requirements should apply.

Prescribed copyright requirements are also to be applied to any documents submitted under the Act, to ensure that information can be published without infringement of copyright.

This amendment promotes transparency and accountability and also aligns with the Western Australian Whole of Government Open Data Policy. It will also ensure that publication of documents can be done in an efficient manner reducing administrative burden.

Environmental Protection Covenants (page 223)

Currently, a condition can be imposed on a clearing permit requiring the permit holder to give a conservation covenant or agreement to reserve under the *Soil and Land Conservation Act 1945* or some other binding undertaking to establish and maintain vegetation.

There are issues with the enforceability and scope of those covenants, agreements and undertakings because the CEO has no control over whether a covenant or agreement is entered into. Further, a conservation covenant under either the *Soil and Land Conservation Act 1945* or the *Biodiversity Conservation Act 2016* must be consistent with those Acts, the objects of which relate to soil conservation and biodiversity conservation respectively, rather than the broader environmental objects of the EP Act.

The Bill includes a new part, which provides for environmental protection covenants. A condition of an EP Act approval may require a person to enter into, or arrange for another person to enter into, an environmental protection covenant, which will be enforceable under the Act. These covenants will be more flexible than those available under other legislation, may be either in perpetuity or for a specified

period, may contain positive or negative obligations, and may be amended. They will also be open to appeal consistent with current conditions set through the EP Act.

Environmental monitoring programs (page 292)

Amendments are proposed to the EP Act to enable cost recovery from industry for key state environmental monitoring programs that assess cumulative industry impacts on health and the environment.

Two examples of such programs are the transfer of responsibility for the Port Hedland Industries Council's air quality monitoring network for the monitoring of dust levels to DWER and implementation of the proposed Murujuga Rock Art Monitoring Program including the atmospheric deposition monitoring and ambient air quality monitoring network.

The Bill will introduce head powers for implementing environmental monitoring programs (EMPs) in consultation with relevant industry and community stakeholders to address cumulative impacts from industry. The cost-recovery framework will require specified licence holders to contribute to the costs of the EMP consistent with the principle of "polluter pays" under section 4A of the EP Act.

A new agency special purpose account (Environmental Monitoring Fund) will be established for industry financial contributions with the funds to be used only for the purposes of an EMP.

Provide a head power for certified environmental practitioners (page 341)

The quality and content of documentation submitted for assessment under the EP Act can be highly variable. Accreditation of environmental practitioners to certify documents prior to their submission has the potential to save time and resources for both government and industry, improve the quality of documentation provided and therefore the accuracy of predictions and management responses and therefore the timeliness of approvals.

The amendments will enable recognition of accreditation in line with work of the Heads of Environmental Protection Agencies Australia and New Zealand National Certification of Practitioners Working Group, which was established to improve the level of assurance in the quality, reliability and accountability of environmental reports and documentation provided to government.

Recognition of an accreditation and certification scheme will support the environmental consulting industry by setting minimum standards for environmental practitioners, ensuring that scientifically robust documentation is submitted to support

decision-making under the EP Act (including referrals and applications, scoping and assessment).

Injunction to apply to a broader range of matters (page 267)

The CEO does not have an express power to apply for an injunction from the Supreme Court to restrain breaches of the offences in Part IV and Part V. This power currently only applies in respect of clearing offences under section 51S.

The Bill allows the CEO to apply for a statutory injunction to restrain breaches in a wider range of circumstances than available via common law injunctions.

2.2 Improvements to administrative efficiency

A number of provisions create unnecessary delays and inflexibility in the administration of the EP Act.

For example, it is currently not possible to amend the purpose of a clearing permit. It is also necessary to give notice of an amendment to a permit or licence where the amendment is made to give effect to a Minister's appeal decision and must be implemented. The voluntary surrender of a licence or permit is treated the same way administratively as a revocation for breach.

Minor amendments to address a range of administrative inflexibility and inefficiencies have been made in the Bill.

2.3 Part I - Preliminary

The purpose of the EP Act as outlined in the long title is

"to provide for an Environmental Protection Authority, for the prevention, control and abatement of pollution and environmental harm, for the conservation, preservation, protection and enhancement and management of the environment and for matters incidental with the foregoing."

The object of the EP Act is to "protect the environment of the State", having regard to a number of environmental principles, the first four of which come from the Intergovernmental Agreement on the Environment. According to the second reading speech for the Environmental Protection Amendment Bill 2002, these are not principles of sustainable development, a concept that involves economic and social considerations beyond the scope of the EP Act.

The second reading speech goes on to clarify that it would be reasonably expected that these principles might be given specific consideration in the development of policies, strategies and broad regulations.

Amendments in Part I are to definitions that are a consequence of amendments to other Parts of the EP Act and therefore are not discussed in this section.

2.4 Part II - Environmental Protection Authority

Part II of the EP Act establishes the EPA as an agent of the state with various advisory functions listed in section 16, including:

- to conduct environmental impact assessments;
- to advise the Minister on environmental matters;
- to prepare, and seek approval for, environmental protection policies;
- to promote environmental awareness within the community and to encourage understanding by the community of the environment.

It also sets out the composition of the EPA members and procedures for holding meetings.

EPA Chairman to be either full-time or part-time (page 26)

The EP Act currently provides that the duties of Chairman must be performed on a full-time basis. The amendments allow all members to be appointed on a part-time or full-time basis as determined by the Minister on recommendation of the Governor.

Use of modern technology to support EPA meetings (page 29)

The EP Act does not provide for EPA meetings to be facilitated using technology such as teleconference or video conference, nor allow resolutions to be passed without a meeting. Proposed amendments allow meetings of the EPA to be conducted using technology, and resolutions to be passed without a meeting if assented to by all members in writing. This is consistent with more contemporary legislation such as the *Waste Avoidance and Resource Recovery Act 2007*.

2.5 Part III - Environmental Protection Policies

Part III sets out the process and requirements for developing environmental protection policies, including the role of the EPA in drafting and consulting on these, and the Minister's role in approval. Once approved by the Minister, environmental protection policies are laid before Parliament and have the force of law.

An approved policy may set out the basis on which the portion of the environment to which it relates is to be protected; or pollution of, and environmental harm to, the portion of the environment to which it relates is to be prevented, controlled or abated, and may delineate programmes for that protection or that prevention, control or abatement.

There are currently four environmental protection policies in force: Western Swamp Tortoise Habitat, Goldfields Residential Areas Sulfur Dioxide, Kwinana (Atmospheric Wastes) and the Peel Inlet – Harvey Estuary.

Some stakeholders have suggested various changes to Part III. As experience has shown that environmental protection policies have mixed effectiveness, it is proposed that before considering such amendments, there be a review of the effectiveness of this Part, including opportunities for improved practices and recommendations for change.

No changes are proposed at this time.

2.6 Part IV - Environmental Impact Assessment

Part IV of the EP Act provides for the EPA to assess the environmental impacts of proposals and planning schemes, which are likely, if implemented, to have a significant effect on the environment.

The EPA, in considering referrals of significant proposals made under section 38 of the EP Act or schemes referred under section 48A, may decide to assess the proposal or scheme.

Following the assessment, it may make recommendations to the Minister for Environment as to the setting of conditions and procedures to be imposed under section 45. Alternatively, the EPA may decide not to assess a proposal and in doing so provide advice to other decision makers, including the CEO of DWER.

The Bill has a number of provisions to streamline and improve regulatory efficiency of the environment impact assessment process.

Referral of proposals (page 52)

The EP Act does not expressly allow for a referred proposal to be withdrawn where a proponent does not wish to proceed. Given the operation of section 38(5j), there is a risk that a proposal once withdrawn (or partially withdrawn) cannot be referred again. While the termination of an assessment under section 40A allows the proposal to be referred again, this currently only applies after a decision has been made to assess the proposal. The Exposure draft Bill allows the EPA to declare a referral to be withdrawn if no response is received within the specified period from the proponent, or if the proposal was referred by a person other than the proponent, with the agreement of the proponent.

Significant proposals may be referred to the EPA by third parties without sufficient information about the proposal. It is intended to give the proponent the ability to amend a proposal after referral to better define the proposal prior to a decision being made about whether it should be assessed. The proponent will also have a separate ability to have a proposal withdrawn where it notifies the EPA that it does not wish to proceed with the proposal.

In deciding whether to assess a proposal, the scope of that assessment and providing recommendations to the Minister, the Bill provides that the EPA may take into account the role of other statutory decision-making authorities in regulating the environmental impacts of that proposal. The intent is to ensure that the EPA can decide not to assess a proposal, or a particular impact of a proposal, where the impact on a key environmental factor can be adequately regulated under other parts of the Environmental Protection Act or other written laws. This amendment reduces duplication of assessments and approvals.

Assessment of proposals (page 58)

The Exposure draft Bill clarifies that the Minister may direct the EPA to assess or further assess a proposal after the EPA has decided not to assess the proposal and the Minister, having determined a section 101(1)(a) appeal, has upheld the EPA decision. The Minister will have the power to direct the EPA to assess or re-assess a proposal more fully or more publicly (based on new information, or failure to consider

something in the initial decision), even after the EPA's decision not to assess the proposal is upheld on appeal.

It is proposed to amend section 39A so that the EPA has discretion to determine which decision-making authorities it will notify of its decision to assess a proposal (and are therefore constrained from making a decision which allows its implementation). The intention of this amendment is to allow the EPA to identify only the major decision-makers in relation to an approval rather than being required to give notice to every government body which must grant an approval connected to the proposal, no matter how minor and unconnected with the proposal's environmental impacts.

Strategic assessments (page 62)

It is widely recognised that strategic approaches, rather than case by case assessments, can lead to more efficient planning of projects and better environmental outcomes. Provisions in the EP Act allow for the assessment of 'strategic proposals' by the EPA. Under these provisions, assessment of 'strategic proposals' may give rise to more streamlined consideration of future 'derived proposals' that fall within the parameters of the strategic proposal. Using this approach to assessment allows the EPA to consider cumulative environmental impacts on a sub-regional and regional basis, rather than on a proposal by-proposal basis.

Examples of strategic proposals are a plan for the development of an industrial precinct, a program of aquaculture development by multiple proponents in a defined zone, a structure plan for urban development of land, and a plan for extensive infrastructure over a wide area.

The draft Bill modernises the EP Act to expressly define strategic assessments and to improve the definition of strategic proposals by using terminology consistent with that used in other jurisdictions, including the EPBC Act. These amendments will provide clarity and align the EPA's ability to conduct strategic assessments with similar processes in other jurisdictions.

Implementation decisions for proposals (page 74)

Once the EPA has provided its assessment report to the Minister, the Minister must determine any appeals received in objection to the content and recommendations in the EPA's report. Having determined the appeals, under section 45, the Minister is to then consult with other decision-making authorities and reach agreement on whether the proposal should be implemented, and what conditions should be applied.

If an appeal is lodged in respect to the EPA's report, the proposal cannot be implemented and the conditions and procedures not agreed or decided under that section, otherwise than in accordance with the appeal decision. The Minister's appeal decision relates only to environmental matters.

In *Conservation Council of WA (Inc) v the Hon Stephen Dawson MLC* [2018] WASC 34, the Supreme Court found section 45(6) merely requires the Minister and decision-making authorities to take into account the contents of the EPA's report and recommendations, as amended through the appeal process, during its section 45

consultation and agreement process. However, the section 45 process allows a range of matters to be considered, and therefore the final outcome may differ from the recommendations of the EPA, which are based only on environmental matters.

The Exposure draft Bill addresses the judgment, and clarifies that the Minister's appeal decision does not constrain the outcome of the decision-making process under section 45(1). This is done by amending the current subsection 45(6)(a)(ii) to require the Minister and other decision-making authorities to have regard to the outcome of an appeal in making an agreement under section 45.

The Exposure draft Bill also amends section 45 so that the Minister for Environment is only required to consult and attempt to reach agreement with those decision-makers relevant to the proposal and its environmental impacts. The intention is to only include those decision-makers who have a significant role in regulating a proposal and the aspects of the proposal likely to have significant environmental impacts, rather than minor, routine approvals.

The Exposure draft Bill clarifies that the Minister may transfer responsibility for a proposal after a statement that records the implementation agreement or decision has been published.

Surrender or Revocation of Implementation Agreement (page 86)

It is also proposed to provide that if a proposal is not substantially commenced by the commencement date specified in the implementation agreement or decision, then the Minister may revoke the implementation agreement.

One of the shortcomings of the current EP Act is that once the Minister approves a proposal, there is no provision to withdraw or suspend the approval if, for example, the proponent decides not to proceed with the proposal or the proposal is complete.

The Exposure draft Bill includes amendments allowing an implementation agreement or decision to be revoked or expire:

- (a) where it is granted for a finite period, at the end of that period;
- (b) where a condition provides that substantial commencement must occur before a specified date and this does not occur;
- (c) in any other case, with the agreement of the proponent

Conditions (page 744)

To provide greater clarity and certainty regarding the types of implementation conditions that may be imposed, a provision similar to section 511 and 62A of the EP Act is proposed to specify the types of implementation conditions that may be imposed. These include the power to enter into covenants and impose offsets, including making monetary contributions to a fund for counterbalancing the impacts of the implemented proposal. The list is not exhaustive and does not limit the types of conditions that the Minister may impose.

Changes to conditions can be made after an implementation statement has been given to a proponent. Other than minor changes, the Act currently does not allow the Minister to change conditions until the EPA has undertaken an inquiry.

The Exposure draft Bill expands the scope of the minor changes that the Minister may make to conditions without an EPA inquiry. In particular, the Minister may make changes at the request of the proponent if the Minister considers that the implementation of the proposal under the amended conditions will not have a significant detrimental effect on the environment in addition to, or different from, the effect of the proposal under the existing conditions. This is equivalent to the test that is currently used in section 45C for changes to proposals and ensures that conditions remain current and effective. This criteria will also be applied in the case of revised proposals to determine the changes to existing conditions that can be made without a section 46 inquiry when issuing a new combined Ministerial Statement.

Where changes to conditions are subject to an inquiry by the EPA before a decision is made, the Minister must currently consult with all decision-making authorities that were consulted on the original decision about whether to implement the proposal. This is the case regardless of whether the change is relevant to that decision-making authority. The Bill provides that the Minister need only consult with relevant decision-making authorities whose functions are affected by the changes to the conditions.

There is also an express power to impose conditions allowing for staged implementation of a proposal, so that different conditions may apply to different stages of the proposal, and conditions may prevent subsequent stages of a proposal being commenced until the CEO is satisfied that any specified preconditions have been met.

Changed proposals and revised proposals (page 71)

Under the current section 45C, the Minister may approve of a proponent's change to a proposal after a statement has been issued, without the need for the proposal to be referred to the EPA. The approval of a change under this section, without EPA assessment, must not occur if the Minister considers that the changes to the proposal might have a significant detrimental effect on the environment, in addition to, or different from, the effect of the original proposal.

The Minister's determination under section 45C depends upon the proponent supplying accurate information. The consequences of such Ministerial decisions can be very significant.

Under section 112, it is an offence to provide information in compliance with a requirement under the EP Act which is false or misleading. However, section 45C does not include any capacity for the EPA or the CEO to require information, and therefore section 112 does not apply.

To address this issue, the Exposure draft Bill proposes amendments to section 45C to enable the Minister to require information when a proponent makes a request to change the proposal.

Sections 43A and 45C in the EP Act currently allow minor changes to be made to a proposal during assessment (section 43A) and after a Ministerial Statement has been given (section 45C) without a 'revised proposal' being referred. It is proposed to streamline the process for amending a proposal during assessment. Rather than requiring referral of a new "revised" proposal in some cases, all changes shall be made under section 43A. If the EPA agrees to a proposed amendment, the EPA shall determine whether the proposed amendment would justify setting a different level of

assessment, require further information from the proponent, or further public review.

The EP Act does not define the term 'revised proposal' or expressly provide for the referral and assessment of a revised proposal.

The Exposure draft Bill inserts a provision which clarifies the process for referral and assessment of a significant amendment and that the proposed changes are to be assessed in the context of the entire project.

Compliance and enforcement (page 85)

The 2003 amendments to the Act introduced an offence for implementing a proposal that the Minister has decided may not be implemented. The seriousness of this offence and potential for serious environmental harm is not adequately reflected by the current penalty. The maximum penalties are amended to be consistent with monetary penalties for intentionally causing serious environmental harm.

Currently the Minister may only stop the implementation of a proposal for a period not exceeding 24 hours where the Minister is not satisfied with any relevant monitoring conducted or on receiving a report from the CEO or a decision-making authority that an implementation condition is not being complied with. The Exposure draft Bill provides for the Minister to issue a notice requiring implementation of a proposal to cease for up to 28 days.

Under section 47(2), if an implementation statement has been served under section 45(5), the proponent is to give the CEO reports and information about the implementation of the proposal as are required by written notice. To clarify the extent of this power, the Bill allows the CEO to require the proponent to undertake such work and provide such information, as is necessary to determine whether the implementation conditions relating to the proposal are being complied with.

Section 48(2) of the EP Act provides that if implementation conditions are included to meet the requirements of another decision-making authority, then that decision-maker may monitor that implementation to determine if the implementation conditions are being complied with. Section 48(2a) then provides that the decision-maker may exercise any power available to it under written law, where there is non-compliance with the implementation conditions.

There are circumstances where it would be appropriate for a public authority that is not a decision-making authority to monitor compliance with proposal implementation conditions. The Exposure draft Bill allows regulatory agencies, which are not necessarily decision-making authorities for a proposal but have regulatory expertise in a particular environmental matter, to monitor and enforce compliance with proposal implementation conditions.

Schemes (page 91)

Under section 48A(1) of the EP Act, when a scheme is referred to the EPA, the EPA must decide whether or not to assess the scheme, or determine that it is incapable of being made environmentally acceptable. It must then inform the responsible authority (and the Minister for Environment in the latter case) within 28 days after the referral.

There is no provision for the EPA to extend this time in the event that it has insufficient information in which to make a decision. The Bill allows for an extension where the EPA has sought additional information about a scheme to enable it to make a decision consistent to the capacity that exists in respect of proposals.

The EP Act does not currently provide for an agreement or decision that a scheme may not be implemented. Under section 48F of the EP Act, the agreement sought between the Minister for Environment and the responsible Minister (Minister for Planning) is in respect to the conditions. The decision as to whether the scheme may be implemented is for the Minister for Planning.

The Bill brings the assessment of planning schemes in line with those that already exist for assessment of proposals. The EPA's assessment report in respect to a scheme must set out the Authority's recommendations as to whether or not the scheme may be implemented and, if it recommends that the scheme may be implemented, the conditions, if any, to which the scheme should be subject; and the Minister for Environment and Minister for Planning can reach agreement that a scheme may not be implemented.

If the Minister for Environment and Minister for Planning reach agreement under the EP Act that a scheme may not be implemented, then that scheme cannot be approved under the *Planning and Development Act 2005*.

Cost recovery (page 91)

Cost recovery does not currently apply for environmental impact assessment under Part IV of the EP Act.

A head power has been included to allow a fee, charge or levy to be imposed on the proponent for Part IV environmental impact assessment to enable cost recovery. Regulations will be developed in consultation with stakeholders and having regard to cost modelling being undertaken.

This amendment is in accordance with State Government policy for cost recovery and the need to reflect a fair and reasonable true cost of services.

The levy funds will be paid into a special purpose account which must be used for the purposes of the administration of Part IV of the EP Act only.

2.7 Part V - Environmental Regulation

Clarifying when decisions on applications for clearing permits or licences are constrained (page 120 and page 151)

Constraints on the CEO's decision-making apply where an application for a clearing permit or licence is related to a proposal which has been referred to the EPA under section 38, and for which a decision-making authority is precluded (by section 41) from making a decision that could cause or allow the proposal to be implemented.

To avoid doubt, promote better definition of significant proposals, and ensure that Ministerial and decision-making authority consultation under section 45(1) is not fettered, an amendment is proposed to clarify that the CEO may not make a decision on a clearing permit or licence application which have the effect of

leading the proposal down the road of implementation in potential contradiction of the advice of the EPA or the decision of the Minister.

For example, if infrastructure such as a port or railway would not exist in the absence of a mining operation, a decision on an application for this infrastructure prior to the Minister's implementation decision on the mining operation would be constrained.

Clearing of Native Vegetation (page 111)

The provisions to regulate clearing of native vegetation were inserted into the EP Act in 2003, and have been operating since 8 July 2004.

Under the EP Act, clearing of native vegetation is an offence unless a permit is held or the clearing is exempt. Exemptions for clearing authorised under written laws are set out in Schedule 6 of the EP Act, while exemptions for routine land management practices are set out in the Environmental Protection (Clearing of Native Vegetation) Regulations 2004. The exemptions in regulations do not apply in environmentally sensitive areas set out in a notice made by the Minister for Environment.

The principal criticism that has been levelled at the clearing provisions is their complexity, and that they are focused on process rather than outcomes. This view is at the heart of many stakeholder submissions made during previous reviews.

The Bill simplifies and improves the provisions for clearing of native vegetation by focusing on environmental outcomes rather than administrative processes.

Declaration of Environmentally Sensitive Areas - section 51B (page 112)

The Minister for Environment declares by notice either a specified area of the state, or a class of areas of the state, to be an environmentally sensitive area (ESA). Consultation requirements are set out in this section. Exemptions to the requirement to hold a clearing permit prescribed under the Environmental Protection (Clearing of Native Vegetation) Regulations 2004 do not apply within ESAs (s51C(c)). The ESA Notice remains in force until it is repealed by the Minister. The ESA notice is therefore fixed in time and needs to be re-gazetted if any updates are required.

The Minister is required to follow the requirements of section 51B each time the ESA Notice requires updating regardless of whether the only change is to update the ESA so that it adopts the most recent listings made under other legislation.

It is proposed to address this issue by prescribing ESAs in regulations so that the consultation requirements can be tailored to the nature of the change, rather than needing to follow a prescriptive approach. This will ensure ESAs remain current and relevant, and there is an efficient and effective process for prescribing ESAs. Regulations remain subject to scrutiny by Parliament, which will ensure the development of ESAs is a transparent process.

Referral process for clearing permits (page 115)

Section 51C of the EP Act requires that all clearing of native vegetation must be authorised by a clearing permit or be subject to an exemption. This results in an

administratively burdensome process for trivial clearing for which an exemption does not apply but which may not have a significant effect on the environment.

A new referral system requires that any clearing not exempt under the Act is to be referred to the CEO for a determination of whether a clearing permit is required, having regard to specified criteria set out in the Act - the size of the area, known or likely environmental values, scientific knowledge and whether conditions are likely to be required to manage environmental impacts. The adoption of this referral-based system will have the effect of ensuring that resources and assessments focus on significant clearing.

The new referral system will provide a robust method to determine whether the clearing should be subject to a permit against the specified criteria, with the decision of the CEO being published. This will prevent the system being tied up in an administrative process that does not result in clear environmental benefits.

For clearing where a permit is required, the clearing provisions, including assessment against the clearing principles in Schedule 5 of the EP Act, would continue to apply.

Use of satellite imagery - section 51R (page 134)

DWER's vegetation monitoring program uses aerial photography and satellite imagery. While aerial photography is used in the prosecution of clearing offences, satellite imagery forms the foundation of the monitoring program, due to its cost-effectiveness and ability to cover a large area of land.

Section 51R of the EP Act provides an averment for aerial photography, but not for satellite imagery. However, while the court may accept satellite images, an expert witness is required to prove that the image is what it purports to be and that it can be relied upon. This is a resource intensive process. A new section provides for the use of 'remotely sensed images' as prima facie evidence.

Licences (page 140)

The Bill substantially replaces the existing Part V Division 3 of the EP Act. Many of the changes modernise and simplify the provisions without changing the intent. For that reason, the issues paper focuses on the key substantive changes.

The current approach regulates works and emissions on prescribed premises as defined in Schedule 1 of the Environmental Protection Regulations 1987 (EP Regulations). There is a poor relationship between environmental risk and regulatory capture. The approach has led to the need for additional regulations to cover situations not dealt with by the EP Act, as well as creating requirements which do not represent any significant environmental risk. It has also led to unnecessary technical breaches of legislation as the provisions are complex and clumsy.

The current Part V Division 3 creates a system under which an occupier is not expressly required to hold a licence. This has resulted in ambiguity about what a licence authorises.

It also raises questions such as whether a licence authorises an activity of a different category to those listed in the licence or any activity that falls within the

category listed; the consequences for carrying out additional activities where these are not included in the licence; and whether these authorised emissions are restricted to those arising from the activities that make the premises a prescribed premises, or every potential emission.

The Exposure draft Bill provides significantly more flexibility and certainty in the regulation of activities and emissions that pose a risk to the environment.

Regulation of prescribed activities (page 140 and page 142)

The Bill addresses these issues firstly by requiring the regulation of prescribed activities rather than prescribed premises. Consequential amendments to the prescribed premises categories in Schedule 1 of the EP Regulations will prescribe both an activity and a threshold level. If met, this will trigger a requirement to hold a licence, which is supported by a new offence of carrying out a prescribed activity without a licence. Under the Bill, a licence will only authorise, or provide a defence for, emissions that are expressly regulated by the licence.

The move from premises-based to activity-based licensing will address the legal uncertainty around the appropriate boundary for a prescribed premises. The ability to define a licence area will remain, but with flexibility to determine the appropriate area over which a licence and its conditions may extend in each case. For example, in some cases, the licence area may only cover the area on which the activities are conducted, even though the cadastral boundary is much larger. This change will also allow licences to overlap where, for example, one physical area is shared by two different operators carrying out separate and independent operations.

The provision for licences to no longer necessarily be connected to a premises also makes it possible to grant a licence to a person other than the occupier of the land. It is not always legally or factually clear who the occupier of a premises is for example where facilities are shared by a number of operators or where there are complex legal agreements in place giving various parties rights to access and use an area.

Where a number of parties are involved in carrying out a business conducting a prescribed activity, the Bill gives the business some flexibility in nominating who should hold the necessary licence by providing that 'any person' carrying out a prescribed activity may apply for and hold a licence. This will greatly improve the effectiveness of the licensing regime by allowing a licence to be granted to the person with day to day control and the ability to take measures to comply with the licence, whether or not that person is the legal 'occupier'.

Voluntary licences (page 141)

The Bill increases flexibility by allowing a person who carries out an activity that does not meet the threshold for a prescribed activity to apply for and hold a licence. The creation of an opt-in system will provide protection for smaller operators that wish to hold a licence to avail themselves of the defences against offences of pollution or serious or material environmental harm.

Liability of persons other than the licensee (page 157)

A person who carries out an activity on behalf of a licensee, such as an employee or contractor, will also be required to comply with the licence conditions. This is intended to ensure that responsibility for a breach of condition lies with the most

appropriate person, having regard to the level of oversight and responsibility held by the licensee.

Controlled works regulated within licence (page 141-142)

The Bill also improves the regulation of controlled works by combining works approvals and licences into one instrument that can authorise and regulate controlled works and activities. This will simplify and streamline processes and reduce administrative burden for both the regulator and licensee.

Ambiguity in the current Act is addressed by clarifying when approval is required to carry out controlled works, and by enabling such works to be added to a licence by way of amendment, rather than requiring a new approval. It also ensures that the design and operation of a prescribed activity is integrated.

Decisions (page 145)

The Bill improves transparency and accountability by clearly setting out the factors to which the CEO must have regard in determining whether to grant or refuse an application. This includes a new requirement for the CEO to have regard to planning instruments in considering applications in relation to licences, which is consistent with clearing permit provisions and will provide for consistency between the environmental and planning systems.

Revocation or suspension (page 148)

The Bill also provides additional flexibility by allowing suspension or revocation of a licence for non-payment of prescribed fees. Currently, non-payment of a licence fee results in automatic termination of the licence and the administrative burden of a new licence being required without the discretion to suspend.

An ability to give a closure notice where the licence is suspended is included, which may be used to avoid the need for a revocation by allowing requirements to be imposed while the licence is suspended to provide for improvements to be made while investigations take place.

In addition to the requirement for the CEO to have regard to planning instruments and development approval, the grounds under which the CEO can revoke a licence include that a planning approval required to carry out the authorised works or prescribed activity is no longer in force.

Vegetation Conservation Notices (page 188)

To improve regulatory effectiveness and transparency, amendments allow the CEO to impose additional specified measures in a vegetation conservation notice, specifically monitoring, record keeping and reporting. This is to ensure the CEO receives information on the specified measures required to be taken by the recipient of the vegetation conservation notice from that recipient, and can assess compliance of those specified measures.

The definition of wetland in section 70(4)(b)(iv) is inconsistent with the definition of 'wetland' in Schedule 5 of the EP Act. This is as a result of amendments made as part of the debate on the 2003 Amendment Act. The definition in section 70(4)(b)(iv) should have been consequently amended at the time of the Bill to be

consistent with that in Schedule 5. The proposed amendment to the definition of wetland rectifies this oversight.

Defences (page 199)

Clearing (page 198)

There is currently no defence for clearing to prevent danger to human health (e.g. removing a damaged tree that is close to a campsite), where the clearing takes place in an ESA.

An exemption for clearing to prevent imminent danger is currently available under item 2, regulation 5 of the Clearing Regulations. However, this exemption does not apply to clearing that takes place in ESAs.

It is considered that there should be a defence for clearing in an environmentally sensitive area to prevent danger. It is intended that section 74 defences will apply to offences under section 51C, which will be consistent with the approach used for environmental harm and pollution offences.

Defence offered by a licence (page 202)

The Bill narrows the scope of the defence offered by a licence to an offence involving pollution, an emission, or the discharging or abandoning of waste where the licence has expressly authorised the emission or waste, and any limits on that emission or discharge imposed by the conditions of the licence have been complied with.

2.8 Part VI - Enforcement

Entry to premises (page 235)

Section 89 provides inspectors with the power to enter premises for specified purposes, including determining whether there has been compliance with, or contravention of, any requirement under the EP Act. However, difficulties are encountered where premises are locked, as DWER authorised officers do not have the power to enter locked premises, even in the presence of a police officer.

The Exposure draft Bill includes a power for inspectors to use reasonable force, similar to section 110 of the *Swan and Canning Rivers Management Act 2006*, to enforce the EP Act where there are reasonable grounds to suspect non-compliance. 'Reasonable force' could only be used against property, and not against persons and where the use of force is likely to result in significant damage, CEO consent is required before such force is used.

Powers to enter to determine whether an offence is being committed (page 234)

While section 89 provides general powers of entry to a premise for an inspector to determine whether an offence is being, or is likely to be committed, it does not provide any power to remove samples for the same purpose. The Bill empowers inspectors to seize anything that the inspector suspects on reasonable grounds is involved in an offence against the Act, or is evidence of such an offence.

Power to require production of books and other sources of information (page 236)

Section 90(1)(b) provides an inspector with the power to require persons to produce books or other sources of information relating to an emission, or to the manufacture, sale or distribution for sale of prescribed equipment or material.

It does not extend to information relating to environmental harm, clearing of native vegetation, or other potential breaches of the Act which do not involve an emission. The Bill corrects this oversight.

Power to compel to attend to answer questions (page 236)

The power to require persons to answer questions under section 90(1b)(b) does not include a power to compel the person to attend a particular time and place. This has resulted in persons of interest avoiding compulsory questioning by non-attendance. The Bill allows an investigator to require a person to attend at a specified time and place to answer questions where the investigator has reasonable grounds to believe that the person has information relevant to the matter being investigated. Similar powers exist in section 21 of the *Mines Safety and Inspection Act 1994* and section 54 of the *Petroleum Pipelines Act 1969*.

Electronic statements (page 238)

Presently, witnesses who are compelled to answer questions under section 90(1b)(b) of the EP Act may refuse to be recorded electronically. Manual recording of compulsory interviews can take more than 10 times longer than electronic recordings, and such interviews are more likely to be challenged as being inaccurate.

Difficulties are also experienced in verifying statutory declarations in rural and remote areas where the closest Justice of the Peace may be located thousands of kilometres away. The use of electronically recorded statements would avoid the need for a statutory declaration in such circumstances.

The use of electronic recordings of statements is considered to be best practice and the Bill would allow an inspector to record an interview by electronic means. Such an amendment would increase efficiency in enforcing the EP Act and would improve the reliability and accuracy of the interview process.

Averment for appointment of an inspector

In a court case for the offence of obstruction, the State Solicitor's Office was required to prove that an inspector was validly appointed under section 88 of the EP Act. This necessitated several witnesses and numerous documents. An averment is included in the Bill for inspectors similar to that in section 41 of the *Evidence Act 1906* for customs officers.

Recovery of costs for inactivating audible alarms (page 248)

Section 99 of the EP Act provides police officers with the power to enter premises to inactivate an audible alarm which has been sounding for a prescribed period of time and is emitting unreasonable noise. DWER is responsible for paying any fee charged by an assistant (e.g. a technician) and must pass this cost to the owner of the premises.

The cost incurred by DWER in administering this debt recovery process often outweighs the cost of disabling an alarm. The number of alarms which require disabling is also decreasing over time as old alarms are replaced with alarms which meet the current Australian Standards.

The Bill deletes section 99(4) to remove DWER's power to recover the cost of disabling an audible alarm from the owner of the premises.

2.9 Part VIA- Legal Proceedings and Penalties

Modified penalties - Part VIA Division 1 (page 249)

The modified penalty system under Part VIA, Division 1 of the EP Act is currently available for some Tier 2 offences, but not to any Tier 1 offences. In many circumstances, Tier 1 offences which do not include an element of criminal negligence or intentional conduct, would be more efficiently dealt with under the modified penalty system than through a criminal prosecution.

Expansion of the existing modified penalty system to include specified non-intentional Tier 1 offences would improve the flexibility and efficiency of enforcement. The modified penalty system would apply to all Tier 2 offences and non-intentional Tier 1 offences.

The alleged offender would still be able to elect whether to accept or reject a modified penalty notice, as is currently the case under the modified penalty system, or refuse a modified penalty and opt for criminal prosecution.

Consideration of criteria for modified penalties - section 99A (page 249)

Section 99A(1) sets out the criteria which must be met before a modified penalty can apply. The Bill includes an additional criterion in section 99A(1), which requires the CEO to consider the potential, or actual, environmental impact of any conduct giving rise to the alleged offence.

Currently, the CEO may only issue a modified penalty notice if each and every factor in section 99A(1) is met. In many cases, a modified penalty may still be considered appropriate, even where some criteria have not been met.

This inflexibility may be resolved by amending the EP Act so that the CEO must consider each of the criteria listed in sections 99A(1)(c) - (f), rather than requiring each criterion has been met. Each of these considerations would need to be documented in the certificate issued under section 99A(2)(a).

Timeframe for issue of infringement notices - section 99J (page 256)

Section 99J of the EP Act provides an inspector or police officer with 35 days (from the date an alleged offence is believed to have been committed) in which it may issue an infringement notice.

Unlike other criminal offences, DWER is not always alerted to the commission of an offence under the EP Act within a short period of the offence occurring. In addition, the nature of environmental offences also often requires investigation before sufficient evidence is available to identify the alleged offender.

An amendment to section 99J to allow the 35 day time limit to run from the date that the offence first comes to the attention of an inspector, or police officer in

relevant circumstances, would address the difficulties currently being encountered in identifying the offender within the current timeframe and would be consistent with section 114A.

Profits - section 99Z (page 265)

Section 99Z of the EP Act provides the court with the power to order an offender to pay an additional penalty not exceeding the court's estimation of any monetary benefits which the offender has or will acquire as a result of the commission of an offence. "Monetary benefits" do not include any profits which the offender has made as a result of committing the offence.

There have been a number of cases where the offender has made a substantial profit as a result of committing an offence of unauthorised clearing. This profit is often higher than the penalty imposed for the commission of the offence under the Act. This is inconsistent with the principle that a person should not profit from unlawful conduct.

The Bill amends the definition of "monetary benefits" under section 99Z(2) to include any profits which would not have been accrued had the offender not committed the offence.

2.10 Part VII - Appeals

Allowing appeals to be lodged with the Appeals Convenor (page 282)

Currently under the EP Act, an appeal is required to be lodged with the Minister. In practice, almost all appeals are received by the Appeals Convenor. Part 7 of the EP Act is to be amended to enable appeals to be lodged with the Appeals Convenor to improve administrative efficiency.

Where a change to implementation condition is subject to appeal, implementation may continue (page 272)

When implementation conditions are changed following an inquiry by the EPA under section 46 of the EP Act, the proponent may lodge an appeal under section 100(3). Under section 101(3)(c), the lodging of an appeal under section 100(3) prevents the implementation, or continued implementation, of the proposal.

The Bill removes this provision as it generally serves no purpose, where it has already been agreed that a proposal may be implemented. Any environmental risk can be addressed by providing that the implementation conditions, as changed, will apply while the appeal decision is pending.

Appeals Convenor not required to report where committee appointed (page 280)

The Appeals Convenor is required to report to the Minister on all appeals unless the appeal is against a decision of the Minister. Section 106(2) provides that the Minister may, at his discretion, appoint a committee to investigate any appeal, and the committee is then required to report to the Minister. The Bill clarifies that the Appeals Convenor is not required to report to the Minister where a committee has been appointed under section 106(2) and will report to the Minister.

Minister's decision on appeal (page 281)

Section 107(2) states that the Minister may determine an appeal after receiving a report from the EPA or CEO under section 107(1), and the Minister's decision will be final and without appeal.

The provision allows the Minister to make a final decision on appeal without receiving or considering a report from the Appeals Convenor or appeal committee. It is also contrary to section 109(3)(a) that the Minister can determine an appeal against a Ministerial decision otherwise than in accordance with a committee report. This provision appears to be an artefact of an earlier version of the Act, prior to the establishment of the Appeals Convenor and the Bill deletes it.

Appeals committee to consider submissions received by the Minister from a decision-making authority for the proposal (page 280)

This provision requires the Appeals Convenor to consider submissions received by the Minister from a decision-making authority for the proposal where that decision-making authority is not an appellant. The provision appears not to require an appeals committee appointed under subsection 106(2) to follow the same approach. The provision is to be amended to ensure consistent processes in both cases.

2.11 Part VIII - General

Institution of proceedings for offences prescribed under regulations (page 302)

Section 114 of the EP Act sets out who may institute proceedings for Tier 1, 2 and 3 offences. There is no provision for instituting proceedings for offences prescribed in regulations made under the EP Act. This has resulted in considerable uncertainty in determining who can institute proceedings for offences under regulations.

The Bill resolves this issue by amending section 114(1b) so that it applies to Tier 3 offences and offences prescribed for the purposes of the EP Act.

2.12 Schedule 1)

Penalties (page 333)

Section 47(4)

Under section 47(4) of the EP Act, it is an offence for a proponent to implement a proposal if the Minister has notified the proponent that the proposal may not be implemented. The penalty for this offence is the same as the offence under section 47(1) for not complying with proposal implementation conditions that is \$125,000 for an individual and \$250,000 for a body corporate.

The penalty for an offence under section 47(4) has remained the same since the provision was introduced in 2003. The penalty for an offence under section 47(4) is to be increased to \$500,000 for an individual and \$1,000,000 for a body corporate.

Section 112

The penalty for providing false and misleading information under section 112 is to be increased from \$50,000 to \$100,000.

2.13 Schedule 5

Definition of 'threatened ecological community' (page 355)

The *Biodiversity Conservation Act 2016* consequently amended the EP Act to restrict this definition to threatened ecological communities listed under that Act. This has had the unintended consequence of removing the communities listed under the EPBC Act, despite the operation of the bilateral agreement. The Bill rectifies this omission.

2.14 Schedule 6

Exemption for clearing that is a requirement under another written law (page 357)

Clause 1 of Schedule 6 of the EP Act provides an exemption for clearing that is done as a requirement of another written law. There is uncertainty regarding the intent of this exemption and the extent to which it applies to local laws.

The current uncertainty is addressed by amending clause 1 so that it refers instead to clearing that is done to give effect to a requirement to clear under a prescribed written law, and specifically listing the legislation to which the exemption applies in a new Schedule to the EP Regulations 1987. Schedule 6 also includes new items for known requirements under written laws.

3 Further issues for consideration

A number of proposals for changes to the EP Act have been raised since 2003 by stakeholders, Ministers and decision-making authorities, which have been previously considered, but not progressed. Further consideration and feedback is sought on these proposals to determine if they will support the modernisation of the EP Act.

These suggestions have been organised by theme. As the State Government is keen to have open feedback, no analysis of these proposals, or views as to their merit, are presented. It is noted that these suggestions may provide different, often conflicting, recommendations. For this reason, drafting has not yet occurred as the State Government wishes to have the benefit of wider consultation on possible reform directions.

Where appropriate, these will be incorporated into the final Bill for consideration through Parliament.

3.1 New ideas

- Include new provisions under the EP Act to ban certain products or product classes.
- Resources provided for third party and community participation in environmental impact assessment and environmental regulation.
- DWER administers funds in some areas as a result of approvals under the EP Act but there are no specific head powers or hypothecation of the funds specifically provided for under the EP Act.

3.2 Delegations

- Clearly control any delegation of decision-making to non-environmental agencies or officers, to ensure these powers are exercised to protect the environment

3.3 Role of the Environmental Protection Authority

- Require EP Act to prepare and publish its policies on environmental impact assessment and environmental protection in a manner consistent with the objects and principles of the Act, and ensure that these published policies are mandatory considerations.
- Part 2 should include eligibility criteria for the appointment of EPA Board members as a schedule to the Act, which is developed following public and professional consultation.
- Remove duplication issues between the EP Act and the *Heritage Act 2018*. The EPA is not the best entity to assess heritage or culture.

3.4 Environmental Protection Policies

- Section 33 of the EP Act be amended to require public input into the EPA's advice to the Minister on the revocation of any existing environmental protection policy.
- Parliamentary approval should also be required to validate the Minister's decision as in the case for any new environmental protection policy.
- Revise Part III to facilitate the broader adoption of environmental protection policies.

3.5 Assessment

- The EP Act be amended so that the EPA's criteria for determining significance are contained in the body of the Act rather than in the separate administrative procedures.
- Section 38A of the EP Act be amended to make it mandatory for the EPA to explicitly consider and report on the cumulative impacts of every proposal it receives.
- Section 44(3) be amended to clarify that the government may not request or direct the EPA to alter the content of any of its reports prior to publication.
- A review of section 48A of the EP Act be undertaken, together with an amendment of the regulations requiring the EPA to seek public comment on the content of its assessment of planning schemes.
- The current separation applied to planning schemes in the EP Act should be removed, and these should be subject to Part IV in the same way as other significant proposals.
- A confidential peer review process be introduced as a requirement of the EP Act to assess environmental review documents prepared by proponents, similar to the process used for academic publications, with costs recovered.
- Broader powers for strategic assessments to allow cumulative impacts to be more fully considered and regionally important environmental values protected.

3.6 Decision-making

- The EP Act be amended to require decisions made under Parts III, IV and V give effect to the objects and principles as contained in section 4A.
- Include statutory criteria for decision-makers to have regard to when making decisions under the EP Act.
- Require all decision-makers under the Act to provide written reasons where requested.

Modernising the Environmental Protection Act

- **Add statutory criteria** for recommendations by the EPA as to whether a proposal may be implemented.
- **Section 46 of the EP Act** be amended to allow the Minister to revoke an environmental approval if new evidence about the potential for significant environmental harm becomes available.
- **The power to amend works approvals, licences, land clearing permits or implementation agreements or decisions** should be limited to administrative changes. Any substantive changes to such approvals should be subject to robust environmental assessment conditions
- **Require that any significant amendment of implementation conditions** be assessed by the EPA at the same level of public consultation as occurred when the original proposal was assessed.
- **Section 44 of the EP Act** be amended to require that, wherever possible, the EPA impose clear and objectively verifiable conditions so that compliance can be assessed and monitored using measurable outcomes.
- **Clarify how the time limit for implementation of a proposal works.**
- **Additional post approval administrative powers** that could enable multiple Ministerial Statements to be rolled into one, or conversely to split a proposal into two or more Ministerial Statements.
- **Clarification in respect to derived proposals, including that they are subject to a Ministerial Statement.**
- **Clarify revised proposal provisions, including constraints to decision-making and implementation.**
- **Where the EPA relies on other regulators to achieve its environmental objectives, it must verify and substantiate the level of environmental protection achieved through such third parties. It also must not have the effect of diminishing community and third party participation through reductions in transparency, consultation or appeal rights.**
- **DWER and EPA to not make decisions or allow activities that are inconsistent with Recovery Plans under the Biodiversity Conservation Act or EPBC Act, or which would result in increasing threat to a listed species or habitat, or increase a threatening process.**

3.7 Offsets

- **The EPA's policies and guidelines** be amended to regulate and minimise the use of offsets and make explicit the circumstances under which they can be applied.

3.8 Clearing of native vegetation

- The clearing provisions should be moved to a standalone part of the Act to ensure that the specific protection of native vegetation and biodiversity conservation is the focus of regulation (rather than pollution and environmental harm).
- Alternatively, a purpose-specific native vegetation Act could be developed to regulate the clearing of native vegetation and to provide for arrangements relating to carbon farming.
- Reform of the clearing provisions in Part V and in supporting regulations is necessary to avert continued degradation of native vegetation across the State, particularly in highly cleared areas such as the Wheatbelt and the Perth and Bunbury metropolitan areas.
- Areas of reform should include exemptions, principles and definitions applying to clearing.

3.9 Industry regulation

- Include a power to license mobile plant and equipment.

3.10 Compliance and enforcement

- The amended EP Act should require financial assurances to be imposed on all approvals under the EP Act. This is necessary to protect against environmental impacts and to address financial risks to the Government.
- Modernise enforcement options including review of the offences and defences, consideration should be given to introducing civil penalties and civil remedies and the option of third-party enforcement.
- The funding arrangements for the EPA be reviewed to ensure that the auditing and compliance is able to be carried out effectively.

3.11 Appeals

- The current structure of Part VII is currently not optimal in terms of clarity and logic, which is in large part due to the initial drafting of this Part and also due to numerous sets of Part VII amendments made from 1994 to 2010. It is recommended that it be restructured to streamline and modernise the format, reduce duplication, and clarify intent.
- Third party appeals should be allowed against decisions to not assess proposals; decisions not to assess schemes, decisions on whether to implement proposals (not only conditions), decisions on works approvals and licences (not only conditions).

4 Having your say

4.1 How to provide feedback

The Department of Water and Environmental Regulation is seeking your input on both proposed amendments as set out in the discussion paper and Exposure draft Bill, as well as feedback on the proposals raised by stakeholders. In addition, there may be other issues that you would like to see addressed.

Your feedback will help inform the final Environmental Protection Amendment Bill for the consideration of Parliament.

You are invited to share your views by making a submission to the Department of Water and Environmental Regulation.

To make your submission as effective as possible, you are asked to provide your feedback against the relevant section of the Exposure draft Bill or discussion paper. If you are raising an issue outside of the scope of the Bill or discussion paper, please make this clear. Submissions can be made [online](#).

You can also send hardcopy submissions to: EP Act Discussion Paper, Department of Water and Environmental Regulation Locked Bag 10, Joondalup DC WA 6919

4.2 Your legal rights and responsibilities

If you make a submission, please be aware that in doing so, you are consenting to it being treated as a part of a public document. Your name will be published; however, your contact address will be withheld for privacy. If you do not consent to your submission being treated as part of a public document, you should either mark it as confidential, or specifically identify what information you consider to be confidential, and include an explanation. Please note that even if your submission is treated as confidential by the department, it may still be disclosed in accordance with the requirements of the *Freedom of Information Act 1992*, or any other applicable written law. DWER reserves the right before publishing a submission to delete any content that could be regarded as racially vilifying, derogatory or defamatory to an individual or an organisation.

12.3.3 Environmental Protection and Biodiversity Conservation Act 1999 Review – Consideration of WALGA'S submission

Address:	N/A
Owner:	N/A
Applicant:	Shire of Northam
File Reference:	7.2.1.6
Reporting Officer:	Jenny Abbott - Environmental Sustainability Officer
Responsible Officer:	Chadd Hunt - Executive Manager Development Services
Officer Declaration of Interest:	Nil
Voting Requirement:	Simple Majority
Press release to be issued:	No

BRIEF

The Department of the Environment and Energy (DoEE) is conducting an independent review of the Environmental Protection and Biodiversity Conservation Act 1999 (EPBC Act) with the aim of updating and streamlining the commonwealth legislation.

As a response, the Western Australian Local Government Association (WALGA) has produced a draft submission on behalf of local governments with a collective position regarding the independent review and Council is now requested to consider supporting the WALGA submission.

ATTACHMENTS

- Attachment 1: WALGA Independent review of the EPBC Act submission
- Attachment 2: Independent review of the EPBC Act discussion paper by Professor Graeme Samuel.

A. BACKGROUND / DETAILS

The EPBC Act is currently 20 years old and the Commonwealth Government has determined its review and update necessary. A discussion paper by independent reviewer Professor Graeme Samuel has been released as an intended first step in the review process of the EPBC Act. The intention of the paper is to identify areas where reform will deliver the greatest benefit for the environment, business, and the community, while maintaining strong environmental standards.

In response to the legislative review, WALGA has been proactive in assisting local governments by producing a draft submission that local governments can choose to support and provide comment on. The WALGA submission discusses:

- Addressing the environmental decline of the natural environment and the ability of the EPBC Act to effectively address cumulative impacts, regional losses of biodiversity and overall threatening processes.
- The need to place more emphasis on regional planning and strategic assessments to meet the objectives of the Act.
- Reconsidering the recommendations suggested in the 2009 Hawke review that were not adopted by the Australian parliament.
- The requirement for increased cooperation between Local Government and the Commonwealth.
- The support for expanding data collection, national environmental auditing and 'State of the Environment' reporting.
- Support for bioregional planning and the involvement of Local Governments in the process.
- Improving the efficiency of Environmental Impact Assessments.
- Joint assessments under a bilateral agreement with the State government to reduce complexity for Local Governments.
- Transparency and accountability improvements through the implementation of an independent agency/board to conduct assessments and implement the Act.
- The move to a single national list of threatened species and ecological communities.
- A single national offsetting policy and process.
- The development of key performance indicators for the assessment process.
- A permanently based office within Western Australia to represent the state and provide advice on commonwealth legislation.

Due to limited timing between WALGA releasing their draft submission and Council meeting dates in Dec 2019 and January 2020, the local comment period on the submission did not allow time for a significant council review prior to the January 14 2020 submission deadline. It is proposed that in the interim Council considers supporting the draft WALGA submission and provide any additional concerns or comments later in an independent submission directly to DoTEE by the 14 February 2020 deadline.

B. CONSIDERATIONS

B.1 Strategic Community / Corporate Business Plan

Theme Area 4: Environment & Heritage.

Outcome 4.3: Residents and organisations within the Shire of Northam are supported to reduce their environmental impact.

Outcome 4.4: Rivers and waterways in the Shire of Northam are greatly valued and maintained to a high natural standard.

Objective: The Shire of Northam is widely known and maintained as a biodiversity hotspot and the premier destination to experience the Avon River;

Theme Area 6: Governance & Leadership.

Outcome 6.4: The Elected Members of the Shire of Northam provide accountable, strong and effective community leadership.

Objective: Open, accountable and effective decision making.

B.2 Financial / Resource Implications

N/A.

B.3 Legislative Compliance

Shire of Northam and its residents are required to comply with the Environmental Protection Biodiversity and Conservation Act 1999 for 'Matters of National Environmental Significance (MNES) and it is therefore relevant for the Shire of Northam to review any proposed changes in this legislation.

B.4 Policy Implications

N/A.

B.5 Stakeholder Engagement / Consultation

The previous council agenda shut on 2 December 2019, the WALGA draft submission reviewing the Environmental Protection and Biodiversity Conservation Act was received by the Shire on 20 December 2019, not allowing for sufficient time to present to council and obtain a position.

B.6 Risk Implications

Risk Category	Description	Rating (consequence x likelihood)	Mitigation Action
Financial	Cost associated with staff allocation to time consuming reporting to state and commonwealth sectors	moderate (8)	To review and comment on legislative changes with councils position.
Health & Safety	Nil	N/A	N/A
Reputation	Not contributing to legislative governance and being proactive in environmental	Moderate (9)	To review and comment on legislative changes with councils position.

	management of the Shire		
Service Interruption	Nil	N/A	N/A
Compliance	Nil	N/A	N/A
Property	Nil	N/A	N/A
Environment	Potential loss of MNES species and ecological communities	High (15)	To review and comment if environmental regulation is inadequate.

C. OFFICER'S COMMENT

The EPBC Act incorporates both listed plant and animal species in addition to 'Threatened Ecological Communities' (TEC's). In Western Australia there are currently 169 animal species and 413 plant species listed under the Act with multiple species present within the Shire. Of the 25 TEC's within WA, the *Eucalypt Woodlands of the Western Australian Wheatbelt* is the only TEC present within the Shire boundary.

Under the state's Biodiversity Conservation Act 2018 the Eucalypt woodlands is classified as a priority species so the protection associated with this legislation does not apply. The inclusion of this vegetation type within the EPBC Act provides an avenue to ensure adequate protection and appropriate assessment for proposed land uses that could significantly impact on this ecological community. Additionally, this legislation provides an avenue to directly assist the Shire in trying to achieve state and national vegetation retention thresholds identified within the Shires Local Biodiversity Strategy.

The proposed suggestions and concerns raised by WALGA within the discussion paper identify ways to strengthen and streamline the EPBC Act to assist local government with current deficiencies and duplications within state and national legislation. The development of national lists for both TEC's and the offsetting processes would greatly improve the current situation reducing complicated reporting requirements. Emphasis to be placed on regional planning and cumulative impacts is of great benefit where assessment moves away from evaluating on a case by case proposal to evaluating overall impacts covering regions on a strategic level.

In summary staff believe that the issues raised within the WALGA draft submission are valid and are supported. It is therefore recommended that Council support the WALGA submission.



RECOMMENDATION / COUNCIL DECISION

Minute No: C.3859

Moved: Cr Ryan

Seconded: Cr Della

That Council supports the draft submission developed by WALGA on behalf of local government regarding the proposed changes to be made to the *Environmental Protection and Biodiversity Conservation Act 1999*.

CARRIED 10/0

The Coordinator Governance / Administration returned to the meeting at 5:52pm.

Attachment 1



Independent review
of the EPBC Act

Submission

December 2019



Contact:

Nicole Matthews
Environment Policy Manager
WALGA
ONE70, LV 1, 170 Railway Parade West Leederville
Phone: (08) 9213 2039
Email: nmatthews@walga.asn.au
Website: www.walga.asn.au

UNCONFIRMED



Contents

1.0	About us	4
2.0	WALGA's overall comments	4
3.0	Specific comments	5
3.1	Addressing environmental decline and the effectiveness of the EPBC Act	5
3.2	The 2009 Hawke review and the importance of Local Government	6
3.3	Bioregional planning	7
3.4	Strategic assessments	8
3.5	Assessment of actions, involving MNES	9
3.6	Improving transparency to ensure better use of information, accountability and trust in the system (Review guiding principle d)	10
3.7	Streamlining and integrating planning to support ecologically sustainable development (Review guiding principle e)	10
4.0	Conclusion	12



1.0 About us

The Western Australian Local Government Association (WALGA) is the peak industry body for Local Government in Western Australia. WALGA is an independent, membership-based organisation representing and supporting the work and interests of 138 Local Governments in Western Australia.

WALGA provides an essential voice for approximately 1,222 Elected Members and approximately 22,000 Local Government employees as well as over 2.5 million constituents of Local Governments in Western Australia. WALGA also provides professional advice and offers services that provide financial benefits to the Local Governments and the communities they serve.

WALGA's governance structure is comprised of WALGA State Council, the decision making representative body of all Member Councils, responsible for sector-wide policy making and strategic planning on behalf of Local Government, and Zones, (5 metropolitan and 12 country), groups of geographically aligned Member Councils responsible for direct elections of State Councillors, providing input into policy formulation and providing advice on various matters.

2.0 WALGA's overall comments

WALGA welcomes the opportunity to comment on the Independent Review of the EPBC Act Discussion Paper. [Local Governments have been consulted in the development of this submission and it has been endorsed by WALGA State Council].

Local Governments have significant environmental management responsibilities, as recognised in the 1997 *Heads of Agreement on Commonwealth and State Roles and responsibilities for the Environment*, of which the Australian Local Government Association was a signatory along with the Commonwealth and all States and Territories and which provided the basis for the EPBC Act.

The specific responsibility of Western Australian Local Governments in this area is spelt out in the *Local Government Act 1995*, which requires that:

In carrying out its functions a local government is to use its best endeavours to meet the needs of current and future generations through an integration of environmental protection, social advancement and economic prosperity. (S 1.3 (3))

Local Governments in Western Australia have significant interaction with environmental legislation at both the State and Commonwealth level in relation to their land use planning responsibilities and in their role as land owners and managers.

WALGA notes that the discussion paper is intended as the first step in the review process where the review panel is seeking to "identify those areas where reform will deliver the greatest benefit for the environment, business, and the community, while maintaining strong environmental standards." (p3). This submission will, therefore, address high level matters of concern to Local Governments in WA.



3.0 Specific comments

3.1 Addressing environmental decline and the effectiveness of the EPBC Act

The Discussion Paper refers to the overall decline in the natural environment in Australia, notably,

The 2016 State of the Environment Report identifies changing land use, habitat fragmentation and degradation, climate change and invasive species as key pressures on Australia's environment. Many Australian species and habitats are in decline and the rate of this decline does not appear to be slowing. There have been permanent changes for some species and habitats as a result of past activities and ongoing impacts from invasive and feral animals and plants. While some ecosystems — such as oceans — are considered to be in good condition, further declines in habitat and biodiversity are expected. (p13)

Since the beginning of the Act, there have been some clear improvements in some areas, including substantial expansion to the network of parks and protected areas. However, many parts of Australia's environment and heritage continue to decline. (p16)

It is acknowledged that there are many factors that have led to this on-going decline in our natural environment, including policies and actions of all levels of government, including Local Government, and the actions of business and individuals. However, decisions made under the EPBC Act, including the different priorities given to different parts of the Act have had a role to play.

Considerable effort and departmental resources have gone into the environmental assessment and approvals of actions, with little effort going into strategic assessments and bioregional planning, both of which are allowed under the EPBC Act. However, it is generally accepted in the literature on impact assessment that assessment at the level of actions can rarely address the broader issues of cumulative impacts, regional losses of biodiversity and overall threatening processes. Regional planning and strategic assessments can, and should be utilised to address these broader issues.

The EPBC Act is flawed in this regard because actions that could have impacts on MNES are required to be referred to the Minister, whereas strategic assessments and bioregional planning can only be carried out with the agreement and cooperation of the relevant authorities. Whilst it is acknowledged that effective strategic assessment and bioregional planning requires the cooperation of the key agencies and stakeholders, WALGA considers that the EPBC Act should be strengthened to allow the Commonwealth Minister and the Department to give more attention to these parts of the Act.

It is noted that Section 522A of the EPBC Act requires that the statutory review examine "the extent to which the Objects of the Act have been achieved." Two of the existing Objects of the Act are



- b) to promote ecologically sustainable development through the conservation and ecologically sustainable use of natural resources;*
- c) to promote the conservation of biodiversity*

Given the ongoing decline in the natural environment and loss of biodiversity, it is difficult to conclude that these Objects are being met, and that a continued emphasis on assessment of actions rather than favouring strategic assessment and bioregional planning will not address the ongoing decline.

More detailed discussion of both strategic assessment and bioregional planning is provided below.

It is also important to recognise that the implementation of the EPBC Act has never been properly funded. WALGA considers it is essential that a long term plan for funding important mechanisms under the EPBC Act is established, such as bioregional plans and for gathering data needed to inform decision can proceed.

3.2 The 2009 Hawke Review and the role of Local Government

The first statutory review of the EPBC Act completed in 2009 and carried out by Alan Hawke (the Hawke Review) made 71 recommendations. The Australian Government's 2011 response to the Review was framed around four key themes:

- a shift from individual project approvals to strategic approaches including new regional environment plans
- streamlined assessment and approval processes
- better identification of national environmental assets, including through provision to list 'ecosystems of national significance' as a matter of national environmental significance under the EPBC Act
- cooperative national standards and guidelines to harmonise approaches between jurisdictions and foster cooperation with all stakeholders.

It is regrettable that the amendments to the EPBC Act needed to implement the Government's response were never considered by the Australian Parliament and there has been little in the way of EPBC Act reform (despite a subsequent Australian Government commitment to create a 'one-stop-shop' for environmental approvals).

Most of the recommendations of the Hawke Review and the Government's response are still relevant in 2019. WALGA considers that a priority for this current review should be to re-examine these recommendations and assess their applicability in 2019.

A number of these are relevant to Local Government.

First, the Hawke Review recommended that the Objects of the Act be re-cast taking into account several factors, including that the Minister should "promote co-operation with State,



Territory and Local Government in environmental protection and management" (Recommendation 3, p17). WALGA would welcome greater cooperation between Local Government and the Commonwealth on environmental matters and supports the Objects being revised to give effect to this recommendation.

Second, the Review examined Section 516 of the Act, which requires Commonwealth agencies to report on progress towards ecologically sustainable development (ESD), and the Department to prepare State of the Environment (SoE) reports every 5 years. Whilst the Hawke Review endorsed the value of both these reporting requirements and called for a set of National Environmental Accounts to be developed, it noted deficiencies in implementation largely related to a significant lack of data. The Review concluded that Local Governments should be involved in any ungraded data collection process which would also have a secondary benefit of "of strengthening the capacity of local government land-use planning decision-making." (Recommendation 67, p320). WALGA supports greater involvement in any expanded data collection in support of national environmental auditing and SoE reporting, and supports changes to the EPBC Act and its operation to give effect to this recommendation.

3.3 Bioregional planning

WALGA supports the greater use of bioregional planning and the involvement of Local Governments in the development of these plans. Bioregional planning is the most appropriate mechanism to address cumulative impacts and key threatening processes, and to begin the process of reversing environmental decline in key areas, for example the WA agricultural region. Whilst such plans have no legislative status, the Minister "must have regard to a bioregional plan in making any decision under this Act to which the plan is relevant" (Section 176 (5)).

The Act does not constrain the scope of a bioregional plan to only MNES, and allows broader issues of biodiversity to be considered. This is a key strength of these plans and would allow the broad issue of biodiversity loss to be addressed at a strategic level and in a cooperative manner.

The Hawke Review recommended an expanded role and use of bioregional plans:

Recommendation 6

1. *The Review recommends that the Australian Government:*
 - a. *expand the role of strategic assessments and bio-regional plans so that they are used more often; and*
 - b. *strengthen the process for creating these plans and undertaking these assessments, so they are more substantial and robust;*
2. *The Review further recommends that the Act be amended to provide:*
 - a. *for bio-regional plans to –*
 1. *change the terminology from 'bio-regional plans' to 'regional plans';*
 2. *allow the Commonwealth to unilaterally develop regional plans; and*
 3. *ensure that the process for delineating a region for the purpose of the Act is flexible;*



Section 176 (2) allows the Minister, with the cooperation of the relevant stakeholders, to prepare a bioregional plan for any region, whether it cover a Commonwealth area or not. Section 176 (3) allows the Minister to provide funds for the preparation of a bioregional plan, but the Act does not currently allow the Minister to provide funds for the implementation of an approved plan. Implementation will likely require cooperation between all levels of government and all relevant stakeholders, and providing adequate funding will be a critical factor in ensuring the success of a plan. It is recommended that a clause be added to this part of the Act that allows the Minister to provide funds for the implementation of an approved plan.

The WA Government recently released an Issues Paper on native vegetation, and it proposed to adopt a bioregional approach to the management of and decision making about native vegetation. Bioregional planning by the Commonwealth could readily be complementary with the WA approach. Local Government would be a key contributor in any bioregional planning.

3.4 Strategic assessments

A key concern for Local Governments' statutory land use planning responsibilities is that many environmental impact assessments by the Commonwealth happen late in the planning process, mostly at subdivision stage (at the time when an 'action' as defined under the EPBC Act is about to occur), when all of the major upstream decisions on land allocation have already been made. Some outcomes of these assessments have required broad land use planning decisions to be revisited to accommodate those changes, which is both costly and time consuming. To this end, WALGA supports the greater use of strategic assessments to avoid these problems. It is noted that the Hawke Review also recommended the greater use of strategic assessments, in part to provide for a more streamlined approvals process as it would avoid assessments at later stages of the planning process and provide greater certainty for developers and planners:

Recommendation 4

The Review recommends that the Commonwealth work with the States and Territories as appropriate to improve the efficiency of the Environmental Impact Assessment (EIA) regime under the Act, including, through:

1. *greater use of strategic assessments;*

Recommendation 6

1. *The Review recommends that the Australian Government:*
 - a. *expand the role of strategic assessments and bio-regional plans so that they are used more often; and*
 - b. *strengthen the process for creating these plans and undertaking these assessments, so they are more substantial and robust;*
2. *The Review further recommends that the Act be amended to provide:*
 - a. *for bio-regional plans to –*
 1. *change the terminology from 'bio-regional plans' to 'regional plans';*
 2. *allow the Commonwealth to unilaterally develop regional plans; and*
 3. *ensure that the process for delineating a region for the purpose of the Act is flexible; and*
 - b. *for strategic assessments to –*



- i. specify mandatory required information for strategic assessments;
- ii. insert an 'improve or maintain' test for the approval of a class of actions in accordance with an endorsed plan, policy or program;
- iii. enhance provision for public engagement; and
- iv. create a 'call in' power for plans, policies and programs likely to have a significant impact on matters of National Environmental Significance, and amending the term 'action' to incorporate these plans, policies or programs;

Local Governments would welcome the greater use of strategic planning and would support changes to legislation that would facilitate this. However, given the current cost recovery model used by the Commonwealth for assessments, WALGA supports the finding of the Hawke Review that applying cost recovery for strategic assessments would act as a disincentive to the greater use of strategic assessments.

It is also worth highlighting that the 2018 Review of the interactions between the EPBC Act and the agriculture sector also noted the need for strategic approaches rather than case by case assessments. The 2018 Review noted that:

The need for a more proactive approach to protecting MNES in regions where agricultural development does or will impact upon MNES health was a recurring theme in consultations undertaken for this Review. Reactive assessment and approval of multiple individual actions in a single area is unlikely to be an appropriate strategy to ensure the long-term viability of agriculture in that region, nor will it necessarily result in the conservation outcomes sought through the EPBC Act (p 63-64)

Of particular concern is that the Act itself, and hence the approach to its implementation, cannot adequately account for the cumulative impacts of multiple individual projects, and so is driving isolated decision making rather than landscape-scale decision making (p64)

The EPBC Act (Section 146 (1)) which states that "The Minister may agree in writing with a person responsible for the adoption or implementation of a policy, plan or program that an assessment be made of the impacts" on MNES, could be strengthened to allow the Minister to be more proactive in these cases in seeking to carry out a strategic environmental assessment.

3.5 Assessment of actions, involving MNES

Local Governments can be proponents for assessments under the EPBC Act mostly for actions involving clearing of native vegetation for its infrastructure needs, notably roads, and for certain proposals within World Heritage areas or areas subject to International Treaties (for example Ramsar wetlands). As well, Local Governments have a significant role to play in land use planning, which can be impacted by decisions related to assessments of MNES on subdivisions or developments.

With respect to Local Governments as proponents of action impacting on MNES, many Local Governments, especially the smaller regional ones, find the Commonwealth assessment process both confusing and cumbersome. In most of these assessments, the action would also be subject to an assessment under the WA EP Act. Joint assessments under a bilateral with the State Government can reduce this complexity for Local Governments. WALGA



supports recent calls by the WA State Government for the implementation of bilateral agreements for both assessment and approvals, which would be facilitated by proposed changes to the WA EP Act.

Irrespective of whether an approval bilateral is agreed to or not, policies related to MNES will have a strong influence on the outcomes any assessment of MNES, and it is important that the provisions of these policies and their implications are communicated to all stakeholders in WA, including Local Governments. As well, these policies need to be developed with a clear understanding of the local context in WA. To this end, it is critical that the Department has a permanent office in WA. Such a presence will help to ensure that assessments are both effective in protecting MNES and efficient by helping to address any local concerns in a timely and comprehensive manner. A local presence could also assist with compliance and enforcement.

3.6 Improving transparency to ensure better use of information, accountability and trust in the system (Review guiding principle d)

A key way to improve the transparency of assessments under the EPBC Act, and environmental protection in general, and to improve trust in the system, is to introduce a greater level of independence in the administration of the Act. One of the strengths of the WA Environmental Protection Act is having an independent agency carrying out the key purposes of the Act, and it is recommended that the EPBC Act be amended to provide for an independent agency/board to carry out assessments, oversee the implementation of the Act and to provide independent advice to the Minister as required. The Hawke Review made a similar recommendation (71):

The Review recommends that an independent National Environmental Commissioner and National Environment Commission be established under the Act and supported by DEWHA.

Transparency would also be improved with the publication of a greater range of information, in particular:

- Advice and reports provided to the Minister in support of decisions made;
- Clear statement of reasons for all decision making made under the EPBC Act; and
- Compliance audit reports.

The Hawke Review also made several other recommendation specifically about transparency of process and public participation which are still relevant in 2019 (44-46).

3.7 Streamlining and integrating planning to support ecologically sustainable development (Review guiding principle e)

In addition to the matters raised above about developing bilateral agreements, the Commonwealth Environment Department having a permanent office in WA and the greater use of strategic assessments and bioregional planning, there are several other changes that could be made to streamline the assessment process, notably:



- The Australian, State and Territory governments move to a single national list of threatened species, and ecological communities;
- The development of a single national offsetting policy and process, or that any bilateral between a State government and the Commonwealth facilitates a single offsets approach;
- Strengthening the process by both the Department and proponents for early engagement with stakeholders, including with indigenous groups and Local Governments; and
- The development of key performance indicators for the assessment process and the publication of performance against these indicators.

3.8 Additional matters

3.8.1 Climate Change

Climate change is a key issue for Local Governments that has implications across almost all aspects of their operations and responsibilities. In Western Australia, Local Governments have been the most proactive level of government on climate change, actively pursuing a range of emissions reduction and adaptation actions, including ambitious corporate and community-wide energy efficiency, renewable energy and emissions reductions strategies, along with programs and policies to encourage residents to reduce their carbon footprint.

The importance with which the Local Government sector regards the threat posed by climate change and need for strong action is recognised in the *WALGA Climate Change Policy Statement* (the Climate Change Statement), endorsed by State Council in July 2018. The Climate Change Statement was the result of extensive consultation across the Local Government Sector, and represents the consolidated position of Western Australian Local Governments:



Local Government acknowledges:

- I. The science is clear: climate change is occurring and greenhouse gas emissions from human activities are the dominant cause.
- II. Climate change threatens human societies and the Earth's ecosystems.
- III. Urgent action is required to reduce emissions, and to adapt to the impacts from climate change that are now unavoidable.
- IV. A failure to adequately address this climate change emergency places an unacceptable burden on future generations.

Local Government is committed to addressing climate change.

Local Government is calling for:

- I. Strong climate change action, leadership and coordination at all levels of government.
- II. Effective and adequately funded Commonwealth and State Government climate change policies and programs.

WALGA Climate Change Policy Statement (2016), p3.

WALGA notes the recommendations of the Hawke Review in relation to the introduction of a 'greenhouse trigger' and the Government's response, which was premised on having a price on carbon. WALGA considers that a broad based market mechanism to reduce Australia's greenhouse gas emissions is the most efficient and effective means of reducing Australia's greenhouse gas emissions and meeting our international obligations at least cost. However in the absence of such a mechanism, WALGA considers that a trigger for large scale emissions of greenhouse gas emissions should be considered for inclusion in the EPBC Act.

3.8.2 Land Clearing

Land clearing is only regulated under the EPBC Act where it impacts a directly protected entity such as a World Heritage area, Ramsar wetland, threatened species, ecological community, or migratory species. However it is clear that excessive land clearing is a key threat to biodiversity and increases greenhouse gas emissions.

WALGA recognises the challenges of regulating land clearing at a national level and the difficulties in operationalising a land clearing trigger as an MNES under the EPBC Act. Nonetheless, WALGA considers that options to address this issue should be considered as part of the review.

4.0 Conclusion

WALGA considers the review of the EPBC Act is an important opportunity to examine both the effectiveness of the Act in protecting Australia's environment and its efficiency in doing so.

A key concern for Local Governments with the current operation of and interaction between the EPBC Act and EP Act is confusion over different requirements, policies, standards and processes of assessments. WALGA supports changes to legislation and associated



processes, for example through the greater use of bilateral agreements that would facilitate a single assessment and approvals process, and the development of a single set of standards, triggers and policies for the assessment process.

It has been argued here that the existing administration of the EPBC Act, with an emphasis on assessment of actions, has not adequately addressed the ongoing decline in the natural environment and loss of biodiversity. Amendments should be made to the Act which would facilitate the greater use of bioregional planning and strategic assessments, which would better address this decline and loss. WALGA considers this would lead to a more efficient and streamlined assessment process for proponents and better environmental outcomes.

WALGA appreciates the opportunity to comment on the Discussion Paper and looks forward to later opportunities to provide input into the review.

Attachment 2

Independent review of the **EPBC Act**

DISCUSSION PAPER



Professor Graeme Samuel AC

November 2019

The review acknowledges the Traditional Owners of Country throughout Australia and recognises their continuing connection to land, waters and community. We pay our respects to their cultures and their elders past, present and emerging.

© Commonwealth of Australia, 2019.

Independent review of the EPBC Act - discussion paper is licensed by the Commonwealth of Australia for use under a Creative Commons Attribution 4.0 International licence with the exception of the Coat of Arms of the Commonwealth of Australia, the logo of the agency responsible for publishing the report, content supplied by third parties, and any images depicting people.

For licence conditions see <https://creativecommons.org/licenses/by/4.0/>

This report should be attributed as '*Independent review of the EPBC Act - discussion paper*, Commonwealth of Australia 2019'.

The Commonwealth of Australia has made all reasonable efforts to identify content supplied by third parties using the following format '© Copyright, [name of third party]'.

Disclaimer

The views and opinions expressed in this publication are those of the author and do not necessarily reflect those of the Australian Government or the Portfolio Ministers for the Department of the Environment and Energy.

Front cover: [iStock.com/Ingrid_Hendriksen](https://www.istock.com/Ingrid_Hendriksen)

CONTENTS

FOREWORD	1
1. ABOUT THE REVIEW	2
The scope and conduct of the review	2
About this discussion paper	3
Make a submission	4
2. ABOUT THE EPBC ACT	5
The role of the Commonwealth	5
The history of the EPBC Act	5
What the EPBC Act does	7
The performance of the EPBC Act	11
3. WHAT THE FUTURE LOOKS LIKE	13
Pressure on the environment will increase	13
The economy will continue to grow	13
Australia's population will grow, with changing expectations	14
Businesses will adapt to remain competitive	14
4. FOCUS AREAS: HOW CAN THE EPBC ACT BE IMPROVED?	15
A. The role of the EPBC Act	15
B. Better environment and heritage outcomes	16
C. More efficient and effective regulation and administration	18
D. Indigenous Australians' knowledge and experience	21
E. Community inclusion, trust and transparency	22
F. Innovative approaches	24
5. PRINCIPLES TO GUIDE FUTURE REFORM	26
6. QUESTIONS AND HOW TO MAKE A SUBMISSION	27
How to make a submission	27

FOREWORD

I am pleased to have been asked to undertake the second independent review of Australia's primary national environmental law, the *Environment Protection and Biodiversity Conservation Act 1999*, also known as the EPBC Act.

Australia's environment is essential to our cultural identity, our way of life, our economy and the prosperity of our society. The connection of Indigenous Australians to Country is central to their culture, spirituality, language and wellbeing. Australia's biodiversity — its plants, animals and ecosystems — is rich, unique and globally important. Our diverse landscapes and seascapes contain up to 10 per cent of all the world's plants and animals. Australia has natural, Indigenous and historic places of significance to the nation and the world, such as the Great Barrier Reef, Uluru, Kakadu National Park, Budj Bim, the Sydney Opera House and the Tasmanian Wilderness.

The EPBC Act plays a significant role in the protection and management of our environment and heritage. It operates within a broader context, alongside other Commonwealth laws and activities and those of state, territory and local governments. The activities of businesses, land managers and the community are also central to achieving environmental outcomes.

The EPBC Act is more than 1000 pages of complex legislation, to which has been added over 400 pages of regulations. This review is a once in a decade opportunity to look closely at the Act, how it operates, and what it is achieving. While it is not a review of environment policy — which is the job of government — this review is a crucial opportunity to make recommendations to ensure that the Act is fit for the future. Changing land use, invasive pests and weeds, a changing climate, more frequent extreme weather events, and fires continue to put pressure on our environment and heritage. Australia's population, the ways that businesses operate, and how governments regulate are changing. Community and business expectations of governments are vastly different from when the EPBC Act was first legislated 20 years ago.

It is vital that our primary national environmental law is well placed to deliver better outcomes for Australia's environment and heritage, for business and for the community. I have released this discussion paper to start the conversation, and this is the first of several opportunities for you to participate in the review. The material it contains is designed to be thought-provoking and includes potential focus areas for reform and possible alternatives. These are not my settled views but are provided for discussion and for you to respond to. I encourage you to be involved and look forward to hearing your views.

Professor Graeme Samuel AC

1. ABOUT THE REVIEW

THE SCOPE AND CONDUCT OF THE REVIEW

The EPBC Act requires that an independent review be undertaken at least once every ten years. The review must examine the operation of the Act and the extent to which its objects have been achieved. The last review was completed in 2009. The Australian Government has issued broad terms of reference for the Review. These are set out in Box 1.

Box 1: Terms of Reference for the Review

The Australian Government is committed to delivering improved national environmental laws to ensure a healthy environment and a strong economy. The EPBC Act is the Australian Government's central piece of national environmental law. The EPBC Act requires there be an independent review at least once every ten years.

These are the terms of reference for the second independent review of the EPBC Act.

In accordance with section 522A of the EPBC Act, the review will examine:

- a) the operation of the Act, and
- b) the extent to which the objects of the Act have been achieved.

The review will make recommendations to modernise the EPBC Act and its operation to address current and future environmental challenges, including consideration of:

- a) The objects in section 3(1)(a)-(g) of the Act
- b) Australia's international environmental responsibilities
- c) Indigenous peoples' knowledge and role in the management of the environment and heritage
- d) implementation of relevant agreements between the Commonwealth, states and territories
- e) other legislation that may relate to the operation of the Act
- f) recommendations of previous reviews and inquiries and significant publications regarding the operation of the Act and potential reform
- g) broad consultation, including with state, territory and other levels of government, non-government organisations, Indigenous peoples, members of the community, industry and academia, and
- h) costs and benefits of recommendations.

The review will be guided by the principles of:

- a) protecting Australia's unique environment through strong, clear and focussed protections
- b) making decisions simpler, including by reducing unnecessary regulatory burdens for Australians, businesses and governments
- c) supporting partnerships to deliver for the environment, supporting investment and creating new jobs
- d) improving transparency to ensure better use of information, accountability and trust in the system, and
- e) streamlining and integrating planning to support ecologically sustainable development.

The Independent Reviewer will provide a report to the Minister for the Environment within 12 months of the commencement of the review.

Professor Graeme Samuel AC will conduct the review, supported by an Expert Panel comprising Mr Bruce Martin, Dr Erica Smyth AC, Dr Wendy Craik AM and Professor Andrew Macintosh. The review will draw upon the knowledge and experience of a range of scientific and other technical bodies throughout the process including the Commonwealth Scientific and Industrial Research Organisation (CSIRO), Geoscience Australia, the six National Environmental Science Program hubs, the Threatened Species Scientific Committee and the Independent Expert Scientific Committee on Coal Seam Gas and Large Coal Mining Development. The knowledge and experience of the Indigenous Advisory Committee and Australian Heritage Council will also be sought.

The review will examine a wide range of information and explore views through extensive consultation with state and territory governments, interest groups, scientists, Indigenous Australians, academics, and the general public. Over the next 12 months there will be many opportunities to be involved (see Figure 1).

Figure 1 – Indicative review timeline

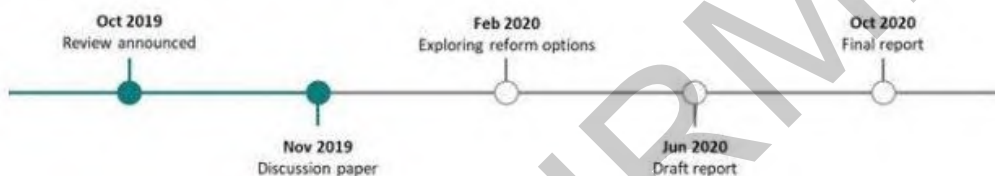

ABOUT THIS DISCUSSION PAPER

This discussion paper is the first step in consultation for the review.

With broad terms of reference, a key early step in the review process will be to identify those areas where reform will deliver the greatest benefit for the environment, business, and the community, while maintaining strong environmental standards.

In addition to outlining the EPBC Act, what it does and where it came from, this paper is intended to be thought-provoking. It identifies some of the long-term pressures on Australia's environment and heritage, and known concerns with the operation of the legislation, especially with its regulatory processes.

Potential areas of focus for the review are explored, and some possible options for reform are floated. These are not settled views, rather a starting point to stimulate discussion. The aim is to explore a wide range of options and to develop sensible recommendations for reform that can be implemented.

Over the next 12 months the review will consider a wide range of information and explore ideas provided by communities, business, environmental groups, Indigenous Australians, academics and others.

Your input is welcome at any time during the review. Targeted engagement activities will be undertaken during the consultation period for this discussion paper. Further consultation will be undertaken as the review progresses.

MAKE A SUBMISSION

All interested parties are invited to provide written submissions to the review, particularly in response to the ideas and questions set out in this discussion paper. You are encouraged to provide your submission as early as possible as this feedback will shape thinking and inform further consultation with stakeholders in 2020.

Submissions on this discussion paper are due by 5pm (AEDST) Friday, 14 February 2020.

Information on how to submit your views is at end of this paper. You can also visit www.epbcactreview.environment.gov.au.

2. ABOUT THE EPBC ACT

THE ROLE OF THE COMMONWEALTH

The Commonwealth, state and territory governments, local government, non-government organisations, the private sector and the community all play a role in the protection and management of Australia's environment and heritage.

State and territory governments have primary responsibility for most land use planning and environmental protection. They have specific environmental laws and programs designed to protect and manage the environment within their jurisdictions. Local government also plays a key role, particularly in local land use planning. The private sector and the community are important participants, particularly in managing land and property and investing in environmental management and restoration.

The Commonwealth's environmental responsibilities, while not explicitly defined in the Constitution, have been interpreted over time and largely rely on indirect Constitutional powers. Prior to the EPBC Act, Commonwealth environmental laws focussed on activities where the Commonwealth had exclusive responsibility, including regulating the activities of Commonwealth agencies and managing Commonwealth land. Over time, the Commonwealth's role has become more expansive, driven in large part through the evolving nature of our federated system of government and Australia's international commitments.

The Commonwealth has an important role in bringing together and facilitating cooperation between the states and territories, particularly to reach agreement on nationally coordinated approaches to protection and management of the environment. This cooperation is particularly important where environmental issues cross state and territory borders.

Commonwealth, state, territory and local governments have formally set out their interests in the environment, their respective roles and responsibilities, and their commitment to the principles of ecologically sustainable development. A foundational agreement was the Intergovernmental Agreement on the Environment (1992) and the subsequent Heads of Agreement on Commonwealth/State Roles and Responsibilities for the Environment (1997). These agreements set out Commonwealth commitments to safeguard matters of national environmental significance (see Box 4) and ensure Australia's international obligations are met.

THE HISTORY OF THE EPBC ACT

In 1998, the Commonwealth implemented its intergovernmental commitments with a comprehensive package of initiatives focussed on environmental issues of national interest and importance and Australia's international commitments. The package included the creation of the EPBC Act¹ and other initiatives, such as the Natural Heritage Trust, Australia's Oceans Policy and the National Environment Protection Council. Together, these initiatives sought to address issues including land degradation, the retention of native vegetation, air quality, sustainable oceans use, and greenhouse gas emissions.

¹ The EPBC Act replaced five (later six) pieces of Commonwealth legislation with a single legal framework and common objectives.

The EPBC Act, as the Australian Government's central piece of national environmental law, reflects the role of the Commonwealth to address matters of national environmental significance, provide a nationally coordinated approach to managing our environment and meet our international commitments.

The EPBC Act remains an important part of a broad suite of Commonwealth and state and territory laws and activities that seek to protect Australia's heritage and the environment (see Figures 2a and 2b). Significant investment by the Australian Government in programs such as the National Landcare Program, Australian Heritage Grants Program, Reef Trust and the National Environmental Science Program also seek to preserve and protect biodiversity and heritage.

Figure 2a. Drivers of the Australian Government's approach to environmental management



Figure 2b. Managing Australia's environment and heritage: examples of government and non-government activities

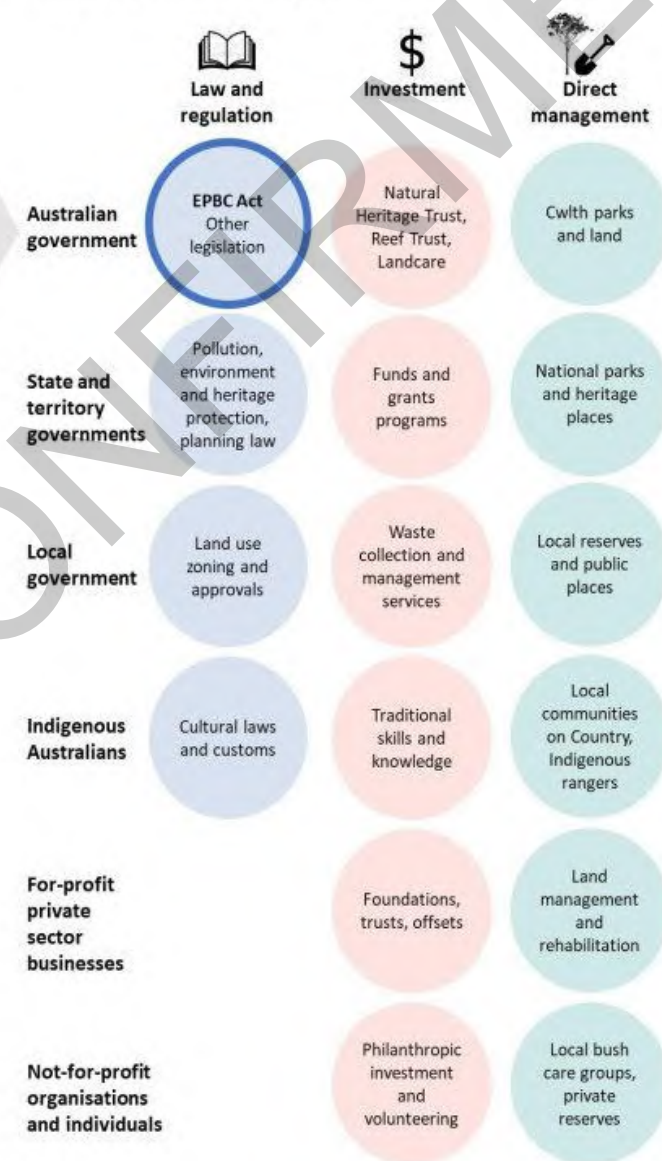

The role of Indigenous Australians in the natural and cultural environment is reflected in the EPBC Act and supported through other programs. For example, the Indigenous Protected Areas Program and Indigenous Rangers Program recognise and promote the role of Indigenous Australians in the conservation and ecologically sustainable use of Australia's biodiversity. Traditional Owners jointly manage Commonwealth National Parks and funding is provided through the National Landcare Program to support Indigenous people and organisations to participate in the delivery of natural resource management activities.

The EPBC Act has been amended on a number of occasions. Wildlife trade was incorporated in 2001 and Regional Forestry Agreements in 2002. New matters of national environmental significance have been added over time; national heritage places in 2004, the Great Barrier Reef Marine Park in 2009, and the 'water trigger' in 2013².

QUESTION 1: Some have argued that past changes to the EPBC Act to add new matters of national environmental significance did not go far enough. Others have argued it has extended the regulatory reach of the Commonwealth too far. What do you think?

WHAT THE EPBC ACT DOES

The EPBC Act passed the Australian Parliament in 1999 and commenced on 16 July 2000.

It aims to protect and conserve Australia's environment, biodiversity and heritage, and promote ecologically sustainable development through the conservation and sustainable use of natural resources.

The Act:

- gives effect to the Commonwealth's commitment to ensure the principles of ecologically sustainable development are taken into account in policy and decision-making process (see Box 2)
- recognises the vital role Indigenous Australians and their knowledge play in the conservation and sustainable use of Australia's environment and heritage
- facilitates cooperative arrangements with the states and territories
- implements international commitments on biodiversity, heritage and other relevant matters
- provides a framework for managing Commonwealth parks and reserves, and
- promotes biodiversity protection and recovery.

² Further detail on changes to the EPBC Act since its commencement can be found at <https://www.environment.gov.au/epbc/about/history>

Box 2: Ecologically sustainable development

Section 3A of the EPBC Act defines the principles of ecologically sustainable development as follows:

- (a) Decision-making processes should effectively integrate both long-term and short-term economic, environmental, social and equitable considerations.
- (b) If there are threats of serious or irreversible environmental damage, lack of full scientific certainty should not be used as a reason for postponing measures to prevent environmental degradation (the precautionary principle).
- (c) The principle of inter-generational equity—that the present generation should ensure that the health, diversity and productivity of the environment is maintained or enhanced for the benefit of future generations.
- (d) The conservation of biological diversity and ecological integrity should be a fundamental consideration in decision making.
- (e) Improved valuation, pricing and incentive mechanisms should be promoted.

QUESTION 2: How could the principle of ecologically sustainable development (ESD) be better reflected in the EPBC Act? For example, could the consideration of environmental, social and economic factors, which are core components of ESD, be achieved through greater inclusion of cost benefit analysis in decision making?

The 'objects' (or objectives) of the Act define what it aims to achieve (see Box 3).

Box 3: The objects of the EPBC Act

- (a) to provide for the protection of the environment, especially those aspects of the environment that are matters of national environmental significance; and
- (b) to promote ecologically sustainable development through the conservation and ecologically sustainable use of natural resources; and
- (c) to promote the conservation of biodiversity; and
- (ca) to provide for the protection and conservation of heritage; and
- (d) to promote a cooperative approach to the protection and management of the environment involving governments, the community, land-holders and Indigenous peoples; and
- (e) to assist in the cooperative implementation of Australia's international environmental responsibilities; and
- (f) to recognise the role of Indigenous people in the conservation and ecologically sustainable use of Australia's biodiversity; and
- (g) to promote the use of Indigenous peoples' knowledge of biodiversity with the involvement of, and in cooperation with, the owners of the knowledge.

QUESTION 3: Should the objects of the EPBC Act be more specific?

The Act identifies nine nationally and internationally important matters, which are defined in the EPBC Act as **matters of national environmental significance** (see Box 4). These include plants, animals, ecological communities, heritage places, water resources and nuclear actions. They are also known as 'triggers', as they trigger the assessment processes under the Act. Individuals or companies must not carry out an action that could significantly impact one or more of these matters unless this action has been assessed and approved by the Commonwealth.

Box 4: Matters of national environmental significance

Part 3 of the EPBC Act sets out the matters of national environmental significance:

- world heritage
- national heritage (added in 2003)
- wetlands of international importance (listed under the Ramsar Convention)
- listed threatened species and communities
- listed migratory species
- protection of the environment from nuclear actions (such as uranium mines, although nuclear power plants are prohibited),
- marine environment³
- the Great Barrier Reef Marine Park (added in 2009), and
- protection of water resources from coal seam gas development and large coal mining development⁴ (added in 2013).

QUESTION 4: Should the matters of national environmental significance within the EPBC Act be changed? How?

The EPBC Act includes both regulatory (decision making) and non-regulatory (cooperative and facilitative) approaches. A broad description of the elements of the EPBC Act is set out in Figure 3.

³ Protection of Commonwealth marine areas

⁴ Known as the 'water trigger'

Figure 3 – Summary of the broad elements of the EPBC Act

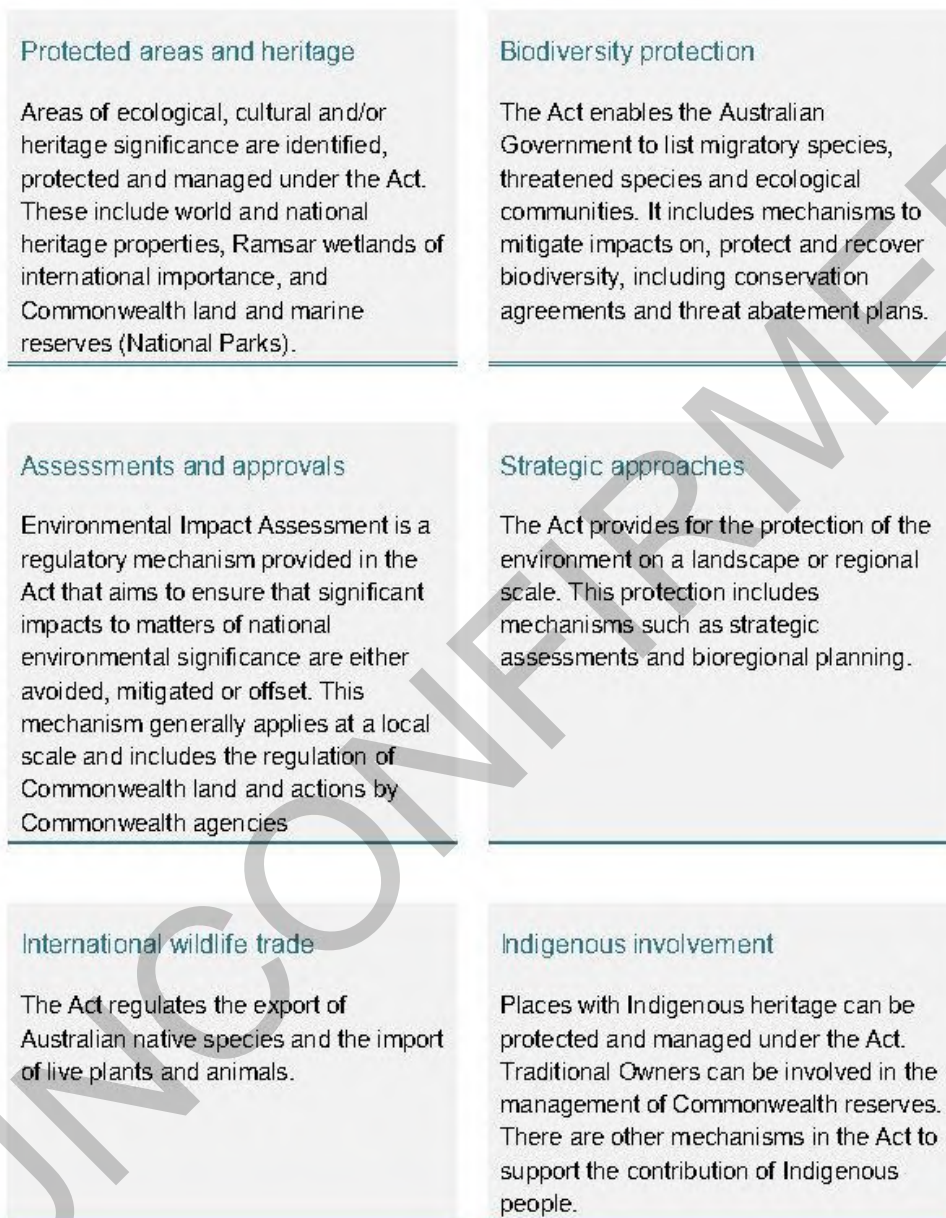

Compliance and enforcement

The Act (particularly Part 17) includes monitoring, audit, compliance and enforcement for approvals and permits. The Act also provides the regulatory framework for general and specific deterrence for those who choose to take actions without required permits or approvals.

Partnerships and advice

The Act enables cooperative partnerships to be established with states and territories, Indigenous people and private landowners. Advisory committees are established under the Act. They provide advice to the Minister on specific issues.

Information and reporting

The Act has mechanisms that require the Australian Government to report on the effectiveness of the Act. These include Annual Reports and State of the Environment Reports.

Decision making

The Act sets out who has the responsibility to make decisions, and what they need to consider. It also provides for decisions to be published and reviewed.

QUESTION 5: Which elements of the EPBC Act should be priorities for reform? For example, should future reforms focus on assessment and approval processes or on biodiversity conservation? Should the Act have proactive mechanisms to enable landholders to protect matters of national environmental significance and biodiversity, removing the need for regulation in the right circumstances?

THE PERFORMANCE OF THE EPBC ACT

Since it commenced, the performance of the Act has been examined through a range of reviews and inquiries. Stakeholders have repeatedly raised a range of concerns with the Act, what it is achieving and how it is operating. This section identifies some of these key concerns as a starting point for discussion.

Effectiveness

In the main, during the life of the EPBC Act the health of the Australian environment and its biodiversity has continued to decline⁶.

The EPBC Act was developed as a key statutory component of a package of initiatives to deliver ecologically sustainable development in Australia. Given it is part of a broader environmental protection system, it is very difficult (and often impossible) to determine the exact impact of the EPBC Act on Australia's environment over its two decades of operation. Notwithstanding this uncertainty, many consider that the operation of the Act has been insufficient to protect and conserve the environment.

⁶ State of the Environment Report 2016 (and previous State of the Environment reports).

This is in light of ongoing impacts of past activities and a failure to adequately manage the impacts of new developments and emerging threats. In contrast to biodiversity outcomes, Australia's network of protected areas has expanded, delivering positive environmental outcomes.

The Act supports only constrained consideration of the social, economic and environmental costs and benefits that relate to some key elements of ecologically sustainable development.

Efficiency

Many businesses regulated under the Act say that it is complex, cumbersome and at times unreasonably delays development. Previous reviews and inquiries have concluded that the EPBC Act is difficult to navigate, inflexible, and duplicates state and territory processes. Inefficient regulation imposes costs on the economy and the community, while having little impact on the environmental outcomes that are achieved through regulation.

Other stakeholders have noted however that Australia's economy has consistently expanded over the past 20 years while key environmental indicators have continued to decline.

Certainty

Some sectors, such as agriculture, highlight that many small businesses lack awareness of their obligations under the EPBC Act. Past reviews have highlighted examples that indicate the current regulatory framework imposed by the EPBC Act is hard to work with, due to uncertainty about what is required and what to expect. There is low understanding about how decisions are made and high potential for unexpected delays in decisions, particularly when individuals, partnerships or small businesses have to interact with the Act's regulatory regime. A lack of clear environmental standards contributes to this uncertainty and costs.

Inclusion

The EPBC Act includes specific objects to recognise the role of Indigenous Australians and to promote the use of their knowledge in the protection of the environment and biodiversity. However, stakeholders have suggested that the involvement of Indigenous Australians in the operation of the EPBC Act has been inconsistent and potentially inadequate. Shortcomings often raised include environmental impact assessment, protection of Indigenous heritage and understanding the cultural significance of Australia's plants, animals and cultural landscapes.

Trust and transparency

The increasing volume of legal challenges to decisions under the EPBC Act indicates both concern about the outcomes of regulatory decisions, and a decline in trust in the decision-making process. Requests for further information about decisions under the EPBC Act are also increasing, suggesting that many stakeholders are seeking greater transparency.

QUESTION 6: What high level concerns should the review focus on? For example, should there be greater focus on better guidance on the EPBC Act, including clear environmental standards? How effective has the EPBC Act been in achieving its statutory objectives to protect the environment and promote ecologically sustainable development and biodiversity conservation? What have been the economic costs associated with the operation and administration of the EPBC Act?

3. WHAT THE FUTURE LOOKS LIKE

As independent reviews of the EPBC Act occur once each decade, it is important that this review ensures its recommendations are fit for the future. To do this well, the review will need to draw on the best available information to forecast the likely future operating context for the Act.

To start this forecasting, the review is examining key reports⁶ — such as the State of the Environment Report 2016, Australian Bureau of Statistics (ABS) population projections, CSIRO's global megatrends analysis, State of the Climate reporting by CSIRO and the Bureau of Meteorology (BOM), and the Treasury's Intergenerational Report — to identify key environmental, social, and economic trends likely to shape the future operating environment of the EPBC Act.

PRESSURE ON THE ENVIRONMENT WILL INCREASE

The 2016 State of the Environment Report identifies changing land use, habitat fragmentation and degradation, climate change and invasive species as key pressures on Australia's environment. Many Australian species and habitats are in decline and the rate of this decline does not appear to be slowing. There have been permanent changes for some species and habitats as a result of past activities and ongoing impacts from invasive and feral animals and plants. While some ecosystems — such as oceans — are considered to be in good condition, further declines in habitat and biodiversity are expected.

The State of the Climate Report projects increases in sea and air temperatures, more extreme weather events, sea level rises, ocean acidification, and shifts in rainfall. While the full extent of climate change impacts on the environment is difficult to determine, CSIRO and BOM indicate that these changes can have a very significant impact on ecosystems, and that widespread ecological change is likely unavoidable.

THE ECONOMY WILL CONTINUE TO GROW

CSIRO's megatrend analysis shows that the Australian economy has grown consistently over the last three decades and is projected to grow into the future. Despite recent headwinds, the global economy is also expected to grow in the coming decades, and continue its shift towards Asia.

These trends are expected to transition millions of people out of poverty, with 65 per cent of the world's middle classes expected to reside in Asia by 2030. By 2030, the Asia-Pacific region is expected to consume more than half of the world's food and 40 per cent of its energy.

These global economic trends are likely to create opportunities for the Australian economy, and increase the pressure on our environment. A growing global middle class will increase demand for Australian products and resources, and the mix of goods and services is likely to change with increased affluence. For Australia, this means the role of tourism in our economy will grow significantly, and changed commodity export and business opportunities may emerge. The trend of increased international trade with, and travel to, Australia is expected to create additional demand for wildlife products and increase the risk of the incursion of pests, diseases and weeds.

⁶ State of the Environment Report 2016; ABS population projections; CSIRO (2012), Our future world: global megatrends that will change the way we live; The Treasury, 2015 Intergenerational Report, Australia in 2055, CSIRO and BOM State of the Climate Report 2018.

AUSTRALIA'S POPULATION WILL GROW, WITH CHANGING EXPECTATIONS

Treasury's intergenerational analysis indicates that Australia's population will continue to age, and could grow by 50 per cent by 2050. This level of growth is likely to increase pressure on the Australian environment, with greater demand for our natural resources.

Submissions to the Hawke and Craik reviews⁷ indicate that Australians' interest in protecting the environment has remained high over the last decade. Governments and communities will need to find new ways to maintain the quality of life for current and future generations within the confines of finite natural resources. There is growing recognition of the value of involving Australian communities, particularly Indigenous Australians, more directly in managing the environment.

BUSINESSES WILL ADAPT TO REMAIN COMPETITIVE

Trust in both public and private institutions has fallen in recent times. Businesses are responding to international and domestic community and consumer preferences. They are playing an increasingly active role in sustainable environmental management to build and maintain community support and social licence. For example, businesses are increasingly looking for opportunities to contribute to the United Nations Sustainable Development Goals (SDGs). The SDGs are a common reference point for all sectors and a framework to focus our collective efforts on a sustainable future for all.

The rapid expansion of the digital world and disruptive technologies is changing business models and altering the economy. It is also resulting in greater expectations among the Australian community toward digital delivery of services and the accessibility of information that is important to them.

QUESTION 7: What additional future trends or supporting evidence should be drawn on to inform the review?

⁷ Report of the Independent Review of the *Environment Protection and Biodiversity Conservation Act 1999* (October 2009), Final Report; Review of the interactions of the EPBC Act with the agriculture sector (2018), Final Report. The full reports can be found at www.environment.gov.au

4. FOCUS AREAS: HOW CAN THE EPBC ACT BE IMPROVED?

A key first step in the review process will be to identify areas where reform could make the biggest difference to the environment, business and the community. While the Reviewer is yet to form a view about particular areas of focus for the review, this chapter outlines six broad potential focus areas for reform to stimulate thinking and promote discussion. The focus areas consider what the EPBC Act should aim to achieve and how to best deliver these aims. The proposals are relevant across the Act.

- A. The role of the EPBC Act
- B. Better environment and heritage outcomes
- C. More efficient and effective regulation and administration
- D. Indigenous Australians' knowledge and experience
- E. Community inclusion, trust and transparency
- F. Innovative approaches

A. THE ROLE OF THE EPBC ACT

While existing agreements between the Commonwealth, states and territories define respective roles and responsibilities in relation to the environment, there is scope within these agreements for the Commonwealth to consider the most appropriate role for the EPBC Act. For example, matters of national environmental significance have changed over time. Some stakeholders have proposed that they could be further altered to remove nuclear actions and the water trigger, while others have suggested adding land clearing and climate change triggers.

There are concerns the EPBC Act has not done enough to protect the environment. Business and government at all levels are affected by environmental regulation of activities. This regulation is resulting in unnecessary uncertainty and delays with flow on impacts to industry, governments and the community. The review provides the opportunity to modernise national environmental law to improve outcomes for industry and the environment both now and in the future.

A reformed EPBC Act could take a 'standards-setting' or coordination approach, relying more on endorsed state and territory processes to address specific impacts on matters of national environmental significance. For example, impacts on plants and animals that live exclusively within the boundary of one state or territory could be dealt with under that jurisdiction's regulatory process.

Alternatively, if the current role of national environmental law remains largely unchanged, there are many potential administrative improvements that could increase certainty and transparency in decision-making. These could include improved communication of expectations, making better use of existing information, greater use of cross-jurisdictional standards such as the Common Assessment Method for threatened species listing, automated publication of decision-making material and streamlined public facing systems.

QUESTION 8: Should the EPBC Act regulate environmental and heritage outcomes instead of managing prescriptive processes?

B. BETTER ENVIRONMENT AND HERITAGE OUTCOMES

The objects of the EPBC Act reflect an ambition to unite biodiversity and heritage conservation with sustainable development principles, and to promote the conservation and sustainable use of natural resources. While states and territories have primary responsibility for land use planning and management of environmental matters within their borders, the Commonwealth has responsibility for matters of national or international significance, as well as its own actions and its own land.

Since the beginning of the Act, there have been some clear improvements in some areas, including substantial expansion to the network of parks and protected areas. However, many parts of Australia's environment and heritage continue to decline. Many Australians have strong views about the outcomes they want from protecting the environment and Australia's heritage.

QUESTION 9: Should the EPBC Act position the Commonwealth to take a stronger role in delivering environmental and heritage outcomes in our federated system? Who should articulate outcomes? Who should provide oversight of the outcomes? How do we know if outcomes are being achieved?

Environmental standards

The EPBC Act currently relies on regulatory process to deliver consistent environmental outcomes in many areas complemented by a range of strategies and plans, such as the Reef 2050 Water Quality Improvement Plan 2017-22. These regulatory processes provide further guidance on environmental standards and targets in some areas. The EPBC Act could be amended to move towards a national standard setting approach, based on the best available science and more closely linked to outcomes.

The EPBC Act already includes tools that enable a form of environmental standards-setting through accrediting other legislative processes or plans that meet national standards. Examples include the accreditation of National Offshore Petroleum Safety and Environmental Management Authority's environment management processes through a strategic assessment, and bilateral agreements with states and territories to undertake environmental impact assessments. Examples of possible alternatives include:

- The Commonwealth could refine policies and strategies to deliver greater clarity on expected national standards related to the objects of the EPBC Act. These standards would continue to act as guidance, aiming to build consensus and national consistency on the outcomes we are seeking to achieve.
- Existing outcomes-based standards such as those for air quality, waste and site contamination under the National Environment Protection Council⁸, and water quality in the Great Barrier Reef catchments, are examples of how the Commonwealth and states and territories could agree to environmental standards.
- The Commonwealth could alternatively prescribe broad national environmental standards that seek to deliver the objects of the EPBC Act, to guide state and territory regulators, with the Commonwealth taking only a monitoring and assurance role.

⁸ National Environment Protection Council Act 1994 (Cth); National Environment Protection (Ambient Air Quality) Measure 2016 (Cth), (Which sets standards agreed to by the Commonwealth and states and territories to measures and limit PM_{2.5} and PM₁₀)

QUESTION 10: Should there be a greater role for national environmental standards in achieving the outcomes the EPBC Act seeks to achieve? In our federated system should they be prescribed through:

- Non-binding policy and strategies?
- Expansion of targeted standards, similar to the approach to site contamination under the National Environment Protection Council, or water quality in the Great Barrier Reef catchments?
- The development of broad environmental standards with the Commonwealth taking a monitoring and assurance role? Does the information exist to do this?

Environmental protection and restoration

The current state of the Australian environment is a legacy of past development and other impacts, much of which occurred prior to the implementation of the EPBC Act. The EPBC Act is focussed on protecting the environment through supporting ecologically sustainable development for activities after 1999. In practice, environmental restoration and sustainable development are intertwined as it is simpler and easier to ensure development is sustainable if it occurs within a healthy and resilient environment. This focus area seeks to consider if the EPBC Act could deliver better environmental outcomes were it focussed on both environmental protection and greater restoration.

The package of environmental initiatives implemented in the late 1990s, of which the EPBC Act was a component, included the \$1.1 billion Natural Heritage Trust which incorporated a focus on restoration of historical environmental impacts. This enabled the EPBC Act to focus on promotion of biodiversity, rather than including a greater regulatory focus on environmental restoration. It may be possible however to achieve better, more robust environmental outcomes by increasing the regulatory focus of the EPBC Act to incorporate environmental restoration.

While the combination of Natural Heritage Trust and the EPBC Act have delivered benefits to the environment, more action to support the recovery of species and ecosystems through national environmental law, or its application, may help in achieving ecologically sustainable development in the future. This is particularly true in the face of growing demands on natural resources and a changing climate.

It is also possible that environmental restoration should predominantly remain the focus of strategies and programs that sit outside the EPBC Act, such as the National Landcare Program. The substantial expansion of carbon farming projects, many of which store carbon by the regeneration of forests, may deliver improved environmental outcomes if the projects expanded into areas with greater biodiversity values.

Mitigation and offsetting requirements could be better directed towards areas of the most beneficial protection and restoration. Better use of new technologies could make information about priority recovery activities more contemporary, regionally relevant and accessible, and support monitoring and reporting.

QUESTION 11: How can environmental protection and environmental restoration be best achieved together?

- Should the EPBC Act have a greater focus on restoration?

- Should the Act include incentives for proactive environmental protection?
- How will we know if we're successful?
- How should Indigenous land management practices be incorporated?

Heritage protection and management

Nationally significant heritage places provide important cultural benefits to the Australian community, in addition to the use and enjoyment they provide to their owners and users. The International Union for Conservation of Nature presently has four of Australia's natural World Heritage properties listed as being of significant concern. Some have also suggested Indigenous heritage values are potentially underrepresented in Australia's heritage places.

Currently, the allocation of resources for heritage protection is risk-based. This risk-based approach to heritage protection could be changed to increase its focus and resources on national and Indigenous managed and World Heritage properties. The Commonwealth could consider if other jurisdictions or sectors could better manage or monitor heritage sites that are currently managed by the Commonwealth. Some categories of future listings could be constrained to help ensure potentially under-represented values increase over time. Further, greater emphasis could be put on developing conservation management plans for listed heritage places and to encourage greater recognition of privately-owned heritage places through appropriate incentives.

QUESTION 12: Are heritage management plans and associated incentives sensible mechanisms to improve? How can the EPBC Act adequately represent Indigenous culturally important places? Should protection and management be place-based instead of values based?

C. MORE EFFICIENT AND EFFECTIVE REGULATION AND ADMINISTRATION

Improving the efficiency and effectiveness of regulation through changes to the Act or its implementation can deliver benefit to both the economy and environment. This may reduce the regulatory costs to businesses and the broader community. It may also improve environmental outcomes, particularly if changes facilitate greater compliance with the law or improve the focus of regulation toward areas of the greatest environmental benefit.

Reducing regulatory complexity

Commentary on the EPBC Act suggests it is challenging to navigate. Specifically, it is repetitive, complex, unclear in some areas and overly prescriptive in others. Changes to reduce unnecessary complexity and provide greater clarity could reduce confusion around obligations, remove duplication between jurisdictions, lower costs and improve environmental outcomes.

This complexity is evident in environment assessments and approvals:

- The EPBC Act includes regulatory tools that intend to reduce the need for case-by-case approvals. Strategic assessments can approve policies, plans or programs that outline upfront

clear rules that apply broadly. Despite these tools existing in the EPBC Act, most projects are still being assessed on a case-by-case basis, with little differentiation for risk to the environment.

- The matters protected under the EPBC Act are often also protected by states and territories. However, jurisdictions can have differing requirements, meaning approval conditions set by a state for a project may not be sufficient to meet EPBC requirements. In other cases, such as for nuclear developments, the EPBC Act requires a whole-of-environment assessment, considering impacts on nationally protected matters but also impacts normally regulated by states and territories, such as noise or local air quality impacts. There may be an opportunity to refine the matters of national environmental significance to remove duplication of requirements.
- The requirement for proponents to self-assess the significance of their development against the range of matters of national environmental significance can be challenging, particularly for smaller organisations and individual land holders. This can impose unnecessary costs as it's often difficult to be certain if actions are significant early in the process, even for relatively low-risk actions that end up not requiring approval under the Act.

The Act could be amended to simplify language and approaches, with more emphasis on clear communication of obligations. There is also an opportunity to unify and streamline key processes under the Act, including public consultation, applications, publication, management plans and issuing permits. The Act could also be substantially simplified through greater use of subordinate legislation, rules and guidelines.

QUESTION 13: Should the EPBC Act require the use of strategic assessments to replace case-by-case assessments? Who should lead or participate in strategic assessments?

QUESTION 14: Should the matters of national significance be refined to remove duplication of responsibilities between different levels of government? Should states be delegated to deliver EPBC Act outcomes subject to national standards?

Simpler and clearer interactions with government

The EPBC Act places obligations on a wide range of organisations and individuals. These include businesses, importers and exporters, farmers, communities, environmental consultants, and researchers. Clearly outlining obligations for specific audiences, and leveraging new technologies and approaches, could deliver improvements in user experience and compliance.

Future economic growth is expected to increase the volume of regulatory approvals and wildlife trade. One option to better manage this increased volume of approvals is to ensure the Act and its implementation keeps pace with community needs and expectations for digital services. A single, streamlined interface that reflects efforts to better align Commonwealth and state and territory processes could significantly reduce frustration and duplicated effort, and provide a central point for input and access to the information used to underpin decisions.

The information collected to support environmental approval decisions under the EPBC Act and those by states and territories is not easily accessible or transparent. Improving access to this information could reduce costs to industry and other stakeholders, as the same information can be re-purposed. It could also increase the consistency of, and confidence in, decision making across different levels of government, as decisions would be underpinned by the same information.

An alternative regulatory model could tailor obligations to the expected level of environmental impact assessed by an initial automated process. This could provide a higher level of transparency, predictability and consistency. Further capacity for fully automated decision making to authorise low-risk projects that do not require referral under the Act could be developed.

QUESTION 15: Should low-risk projects receive automatic approval or be exempt in some way?

- How could data help support this approach?
- Should a national environmental database be developed?
- Should all data from environmental impact assessments be made publically available?

Regional approaches

Many of Australia's ecosystems are at risk from a broad range of threats, including invasive species, habitat loss and climate change. There are also future development pressures from urban growth and resource developments in particular geographic areas. It is possible that these threats and development pressures could be more effectively addressed through a landscape-scale approach, rather than on a project or species basis. While there are a range of definitions of landscape-scale approaches, they tend to include the consideration of large spatial areas through an integrated multidisciplinary approach to better manage the cumulative impacts on the environment, with consideration of economic and social factors. The potential benefit of landscape-scale solutions is that they may enable better protection of matters of national significance, longer-term streamlining of administrative decision making and compliance, and coordinated investment in protection and restoration.

A regional approach has been relatively successful in the Commonwealth marine environment with plans developed for four of Australia's marine regions. These plans identify conservation priorities, strategies and actions to address those priorities and obligations under the EPBC Act.

A number of existing approaches under the EPBC Act such as strategic assessments, bioregional planning and the National Reserve System were designed to deliver landscape-scale approaches. The intent of these approaches is to reduce the need for individual project approvals to protect important areas, while delivering on ecologically sustainable development. In practice, these approaches in their current form have not always fully delivered on this intent with strategic assessments of large areas of land and bioregional plans seen as complex, slow and subject to legislative constraints on their use.

One success has been the use of regional planning and strategic assessments in the Commonwealth marine environment. This success may be linked to the Commonwealth being the sole jurisdiction in these areas. The application of Regional Forestry Agreements outside the EPBC Act is another example of a regional approach. The Commonwealth could expand regional planning to areas where multiple jurisdictions have a role. This could include potentially accrediting state and territory approaches to regional planning, where relevant landscapes exist completely within one jurisdiction. The Commonwealth could retain responsibility for plans that are wholly within Commonwealth jurisdiction, or those that cross state boundaries.

Efforts could also be made to clarify when regional planning should be used within the broader regulatory framework to help focus efforts and resources to those areas where the most benefits can be

gained. For example, where development pressures intersect with areas of high environmental value or to ensure the impact of the combination of individual threats are adequately addressed.

Integrated regional or landscape-scale plans could be a priority for development in partnership with states and territories to meet a range of national and state level requirements, including developing an integrated and representative reserve system, determining priorities for investment and the valuation of co-benefits.

QUESTION 16: Should the Commonwealth's regulatory role under the EPBC Act focus on habitat management at a landscape-scale rather than species-specific protections?

Alternative regulatory approaches

The EPBC Act is an example of a traditional rules-based regulatory model. The Act prescribes rules and processes to be followed and provides penalties if they are not. This approach to legislation relies on the assumption that the processes will deliver the intended outcome. It is also one reason why the EPBC Act is more than 1000 pages long. It is important to question if the current process-based regulatory approach is delivering the desired environmental outcomes, and whether this is being done in a timely or efficient way.

Alternatives to traditional rules-based regulation can be more effective, in certain circumstances, at achieving policy outcomes at lower cost and with less regulatory burden. Legislation should be about achieving clear, specifically determined outcomes, rather than compliance with process. This requires improved performance measurement and reporting to monitor impacts and performance, help set expectations and improve trust in the system.

The EPBC Act could be modified to enable self-regulation or co-regulation where basic conditions are met, such as where the regulated community has a vested interest in being subject to regulation, and where there are well-developed and accepted codes of practice. Accreditation of environmental professionals could also improve consistency of information and trust in advice. The Commonwealth could also further accredit the states and territories, setting national standards and adopting a focus on an enhanced coordination and assurance stance to ensure good outcomes are achieved. Alternatively, the EPBC Act could implement general duties, similar to occupational health and safety duties, applicable to all actions that could impact the environment and heritage.

QUESTION 17: Should the EPBC Act be amended to enable broader accreditation of state and territory, local and other processes?

QUESTION 18: Are there adequate incentives to give the community confidence in self-regulation?

D. INDIGENOUS AUSTRALIANS' KNOWLEDGE AND EXPERIENCE

Indigenous Australians are the custodians of the oldest continuous culture in the world. Over tens of thousands of years, they have built a deep connection with Country. This connection is central to their

culture, spirituality, language and wellbeing. The active management of the environment and associated cultural practices by Indigenous Australians have significantly shaped the natural environment of Australia.

The role of Indigenous Australians in the natural and cultural environment was recognised in the objects of the EPBC Act at its inception. This was a significant step at the time. Three of the eight objects of the EPBC Act recognise the role of Indigenous Australians: Indigenous roles in the protection and management of the environment; conservation and ecologically sustainable use of biodiversity; and promoting the use of Indigenous Australians' knowledge of biodiversity.

Since the EPBC Act was introduced, respect for and appreciation of Aboriginal and Torres Strait Islander people and their cultures has deepened. To strengthen the role of Indigenous Australians in the implementation of the Act, emphasis in the Act itself could be placed on early and genuine engagement with them. The process and nature of longer-term involvement in environmental and cultural management could be determined in collaboration with Indigenous communities as part of this early engagement, reflecting the unique needs of different communities.

One pathway could be to update the objects of the Act to provide more emphasis and clarity on the involvement and interests of Indigenous Australians. This could be achieved by changing the wording in the objects from "to promote the use of Indigenous peoples' knowledge..." to "to provide for the use of Indigenous peoples' knowledge...", and including appropriate supporting mechanisms in the Act. This would provide a more direct and clear role for Indigenous Australians in managing Australia's plants, animals and cultural landscapes.

QUESTION 19: How should the EPBC Act support the engagement of Indigenous Australians in environment and heritage management?

- How can we best engage with Indigenous Australians to best understand their needs and potential contributions?
- What mechanisms should be added to the Act to support the role of Indigenous Australians?

E. COMMUNITY INCLUSION, TRUST AND TRANSPARENCY

Australia's environment is a valuable asset. Greater inclusion of Australians in the processes that protect, manage and promote the environment and heritage may help foster the best environmental outcomes for all Australians. Greater inclusion also facilitates transparency in decision making and fosters community trust in regulators and regulatory outcomes.

Inclusion and transparency

Australians have a long history of active involvement in environmental matters. This role is critical in directing Government, industry and community activity towards important environmental values. The Australian Government fosters these activities through programs that support on ground action, including by investing directly in community environmental programs. Additional models to increase community inclusion could also be considered. For example, Government could work with industry on a code-of-practice to support deep and early engagement of the community in environmental approval applications. Alternatively, Government could seek greater community involvement in co-designing approaches, such as new strategic assessments. It may also be possible for Government to deliver

greater inclusion of Australians in the regulatory decision-making process, such as through new formal advisory bodies that include a range of community interest groups. Further, existing advisory bodies for decision makers could be required to have greater community membership.

Greater transparency of decision making could be achieved by requiring automatic publication of greater information about decisions including for example, decision-making materials, external advice and offset agreements. This would also reduce the risk of administrative delays arising from the diversion of resources to respond to individual requests for information.

QUESTION 20: How should community involvement in decision making under the EPBC Act be improved? For example, should community representation in environmental advisory and decision-making bodies be increased?

Governance, certainty and accountability

Trusted regulatory frameworks have effective governance arrangements that ensure decisions are properly made. Inappropriate governance arrangements, including poor guidance on regulatory requirements, can limit efficient and effective administration of legislation and undermine certainty and trust in the regulatory framework. Effective governance arrangements generally:

- define who sets policy
- identify the responsible decision makers
- identify how advice is used to inform decisions, and
- enable decision makers to be held accountable.

The existing governance model of the EPBC Act involves the Commonwealth Minister for the Environment as the primary decision maker. This is a valid model to consider due to the complex nature of decisions that must consider competing environmental, social, and economic factors, while also remaining accountable to the community. Accountability and certainty could be increased through changes that further clarify existing roles and responsibilities under the Act for decision-makers and those providing advice.

Recently a number of stakeholders have proposed structural changes in governance. Options for broad reform have included creating new advisory bodies to inform decisions on approvals. It has also been suggested that a separate, statutory authority could become the responsible decision maker under the Act, similar to models used at state and territory level or Commonwealth regulators in other sectors. A different model again could be the creation of a single statutory office holder to determine environmental approvals, similar to the Director of National Parks. While these potential changes would alter decision making and accountability, recent public concern with outcomes delivered by other Commonwealth and state and territory regulators suggest improvement is by no means certain. Successful change of this nature would also likely require additional legislative rules and administrative costs.

QUESTION 21: What is the priority for reform to governance arrangements? The decision-making structures or the transparency of decisions? Should the decision makers under the EPBC Act be supported by different governance arrangements?

F. INNOVATIVE APPROACHES

The EPBC Act was created 20 years ago and takes a traditional regulatory approach – imposing rules on individuals and business through legislation to achieve environmental protection. The Act was not designed to consider or promote alternatives, such as ecosystem services markets, alternative financing arrangements, co- or self-regulation, environmental accounting and information and education-based approaches, noting there are likely limitations on the potential for these alternatives. The review provides an opportunity to consider increasing the role of environmental accounting, incentives and ecosystem services markets to complement the right environment protection rules.

Ecosystem services are functions performed by ecosystems that lead to desirable environmental outcomes. They include for example air and water purification, flood mitigation, and the stabilisation of climate in accordance with the Paris Agreement. Examples of potential markets for ecosystem services include tradeable units for carbon sequestration, or those for biodiversity conservation⁹. The expansion of ecosystem services markets in the past 20 years has been helped by the rapid growth in experience, data, analytics and digital technology. Ecosystem services markets for carbon and biodiversity are in limited use by both the Commonwealth and state and territories.

The limited capacity of government resources to directly manage Australia's environment may constrain the achievement of environmental outcomes. Greater use of ecosystem services markets could make it easier for business to meet their obligations by investing in environmental outcomes. There is also an opportunity to take advantage of the greater focus on corporate social responsibility to increase private sector interest in improving the environment.

As noted earlier, where the interests of the regulated community aligns with the regulatory outcome, there may also be advantage in leveraging 'mature industries' ability to self-regulate, with the Commonwealth retaining oversight. These arrangements can be more adaptive in a rapidly changing world and have greater support than traditional regulation, especially if there is connected and coordinated investment in what matters most, with transparency of obligations supported by quality assurance arrangements.

Finally, the provision of greater information and education can change the behaviour of consumers and business, such as through labelling and other information products.

QUESTION 22: What innovative approaches could the review consider that could efficiently and effectively deliver the intended outcomes of the EPBC Act? What safeguards would be needed?

Offsets and market-based approaches

Since 2012, the Department of the Environment and Energy's adoption of a formal offsets policy in environmental impact assessment decisions has created an emerging national biodiversity market. Companies purchase offsets (most often land with similar habitat) and are required to protect them as part of their conditions for development approval under the EPBC Act where residual impacts cannot be

⁹ Creating Markets for Ecosystem Services, Productivity Commission, 2002

avoided or mitigated. The Offsets Policy¹⁰ was developed with a focus on regulatory and scientific considerations rather than the potential for a market. In reality, a national biodiversity offsets market exists in parallel with expanding states and territory biodiversity offset markets.

A greater focus on developing efficient ecosystem services markets may lower costs and support greater investment in the environment. There may also be opportunity to improve the environmental outcomes that the current biodiversity offsets system delivers and the systems that maintain the integrity of offsets.

Providing national biodiversity markets with greater long term certainty, such as converting policy into law, could reduce risk for the private sector when making the required long-term investments in the biodiversity market. Lower risk could be expected to reduce costs. It may also be possible to expand the scope of the national biodiversity market from a focus on offsets toward greater ecosystem recovery.

QUESTION 23: Should the Commonwealth establish new environmental markets? Should the Commonwealth implement a trust fund for environmental outcomes?

QUESTION 24: What do you see are the key opportunities to improve the current system of environmental offsetting under the EPBC Act?

Alternative financing approaches

The use of trusts and other financial mechanisms to deliver environmental outcomes has expanded in the past decade at both the state and territory and Commonwealth Government levels. Their use may have potential to deliver improved environmental and business outcomes.

There are opportunities for governments to increase leverage of private sector investment. For example, investments targeted to deliver sustainable agriculture, carbon emissions reductions and regional development could also deliver improved public good in the form of environmental protection and recovery.

The EPBC Act and its associated policies could be modernised, and data and information systems improved, to enable the scaling up of philanthropic and private sector investment in Australia. This could be achieved by developing national environmental accounts that are clearly understood and usable by both the government, philanthropic and private sectors.

The Commonwealth could also develop its own investment vehicle, such as an environmental trust, to fund direct conservation outcomes and provide a coordinated vehicle to manage EPBC Act offset funding. This could deliver lower costs by enabling strategic investment over longer timeframes. It could also deliver more inter-connected areas of protected habitat than the present offsets policy delivers, improving ecosystem benefits.

QUESTION 25: How could private sector and philanthropic investment in the environment be best supported by the EPBC Act?

¹⁰ *Environment Protection and Biodiversity Conservation Act 1999* Environmental Offsets Policy 2012

- Could public sector financing be used to increase these investments?
- What are the benefits, costs or risks with the Commonwealth developing a public investment vehicle to coordinate EPBC Act offset funds?

5. PRINCIPLES TO GUIDE FUTURE REFORM

It is important that future reforms are guided by a set of principles. These principles should reflect what is important to Australians, and our goals for national environmental law.

We are keen to hear your views about these principles and others we should consider.

Effective Protection of Australia's environment

Protecting Australia's unique environment and heritage through effective, clear and focussed protections for the benefit of current and future generations.

Making decisions simpler

Achieving efficiency and certainty in decision making, including by reducing unnecessary regulatory burdens for Australians, businesses and governments.

Indigenous knowledge and experience

Ensuring the role of Indigenous Australians' knowledge and experience in managing Australia's environment and heritage.

Improving inclusion, trust and transparency

Improving inclusion, trust and transparency through better access to information and decision making, and improved governance and accountability arrangements.

Supporting partnerships and economic opportunity

Support partnerships to deliver for the environment, supporting investment and creating new jobs.

Integrating planning

Streamlining and integrating planning to support ecologically sustainable development.

QUESTION 26: Do you have suggested improvements to the above principles? How should they be applied during the Review and in future reform?

6. QUESTIONS AND HOW TO MAKE A SUBMISSION

In addition to the specific questions asked throughout this discussion paper, the broad questions that this review is seeking to answer are:

- Is the EPBC Act delivering what was intended in an efficient and effective manner?
- How well is the EPBC Act being administered?
- Is the EPBC Act sufficient to address future challenges? Why?
- What are the priority areas for reform?
- What changes are needed to the EPBC Act? Why?

The questions in this discussion paper are provided as a guide only and are not intended to limit your comments. In providing your responses it will be helpful if you:

- where possible, identify which parts of the EPBC Act your comments relate to
- describe what is working well and what improvements can be made
- explain what the impact of these improvements would be on you, others and the environment, and
- provide any available data, evidence or case studies to support your views.

HOW TO MAKE A SUBMISSION

Our preference is to receive written contributions through an online form. The questions in this discussion paper have been extracted into our online form to support you to do this. This form helps us efficiently process comments and submissions, allowing us to focus on the content and ideas rather than administration. Contributions can also be made by post or email. Details for contacting the Secretariat are available on the review website.

Submissions on this discussion paper are due by 5pm (AEDST) Friday, 14 February 2020.

You can make a brief comment at any time on the review website. While comments are easy to make, they are likely to be given less weight than a formal submission.

We will publish each submission and comment on our website, except for those provided to us in confidence. Before making a comment or submission, we encourage you to read the information on how we will protect your privacy (<http://www.environment.gov.au/privacy-policy>) and treat the information that you give us. The Department's Privacy Policy contains information about how to access or correct your personal information or make a complaint about a breach of the Australian Privacy Principles.

The review is committed to treating confidential information responsibly and in accordance with the law. In some circumstances, the review may be legally required to produce confidential information. Any request made under the *Freedom of Information Act 1982* for access to a submission marked confidential will be determined in accordance with that Act. We will publish the name of the individual(s) or organisation making the submission, unless requested otherwise. We will also publish information provided on the stakeholder category that best fits the individual or organisation, and the themes covered by the submission.

We will not publish material on our website that is offensive, potentially defamatory, contains personal information (other than your name) or is clearly out of scope or factually incorrect.

For full details, please visit the review website at: <https://epbactreview.environment.gov.au/>

12.3.4 WALGA'S Third Party Appeal Rights – Preferred Model

Address:	N/A
Owner:	WALGA
Applicant:	WALGA
File Reference:	3.1.16
Reporting Officer:	Jacky Jurmann, Manager Planning Services
Responsible Officer:	Chadd Hunt, Executive Manager Development Services
Officer Declaration of Interest:	Nil
Voting Requirement:	Simple Majority
Press release to be issued:	No

BRIEF

WALGA have requested local governments to indicate if their Council supports or does not support their 'Preferred Model' for Third Party Appeal Rights for decisions made by Development Assessment Panels (DAPs) for consideration at their meeting to be held in March 2020.

ATTACHMENTS

- Attachment 1: WALGA AGM Minutes.
Attachment 2: SAT Information Brochure – Third Party participation in planning matters.

A. BACKGROUND / DETAILS

At the August 2019 WALGA Annual General Meeting (AGM), an item was discussed by members which proposed an amendment to the existing 'Preferred Model' for Third Party Appeal Rights for decisions made by DAPs. A copy of the minutes of the AGM are attached to this Report (**Attachment 1**).

WALGA has previously conducted consultation with local governments on their Preferred Model for Third Party Appeal Rights. The original consultation related to general third party appeal rights on planning decisions in Western Australia, however this was not supported by local governments. Objections related to potential implications relating to cost, timeframes and resourcing.

As a result of the consultation process, the focus of WALGA's Preferred Model has now been narrowed down to third party appeals of decisions made by DAPs. The original model proposed for local government to have an appeal provision, however a recent amendment proposed at the WALGA AGM is to

include “closely associated third parties” as well as local government being able to appeal decisions by DAPs. No definition of “closely associated third parties” has been provided by WALGA.

The perceived benefits of third party appeal rights are outlined in the preferred model on page 29 (Attachment 1), which include local government being able to appeal a DAP decision and defend the merits of their policies and enforceability of their conditions.

WALGA's position has been communicated to the Minister for Transport; Planning who has raised concerns regarding the Preferred Model, stating (refer to page 27-28 of **Attachment 1**):

“the unnecessary complexity and red tape third party appeal rights would add to the planning system, which is contrary to the objectives of the Government’s commitment to planning reform”.

B. CONSIDERATIONS

B.1 Strategic Community / Corporate Business Plan

Theme Area 6: Governance & Leadership

Outcome 6.2: Residents and other stakeholders are actively listened to and their input into decision-making processes are valued.

Objective: Decisions made by the Shire of Northam are communicated and the reasoning clearly articulated to residents and stakeholders.

B.2 Financial / Resource Implications

Concerns have been raised by some local governments that the introduction of third party appeal rights may have financial and/or resourcing implications.

B.3 Legislative Compliance

Currently there are no third party appeal rights on planning decisions made under the provisions of the Planning and Development Act 2005 (WA). All other States in Australia have some level of third party appeals on planning decisions.

B.4 Policy Implications

There are no policy implications associated with this item.

B.5 Stakeholder Engagement / Consultation

WALGA are conducting stakeholder consultation. There is no need for community consultation at this stage.

B.6 Risk Implications

Risk Category	Description	Rating (consequence x likelihood)	Mitigation Action
Financial	Introduction of 3 rd party appeal rights.	Low (2)	Ensure planning framework is current and robust.
Health & Safety	N/A	N/A	N/A
Reputation	Introduction of 3 rd party appeal rights.	Low (2)	Ensure planning framework is current and robust.
Service Interruption	N/A	N/A	N/a
Compliance	Introduction of 3 rd party appeal rights.	Low (2)	Ensure planning framework is current and robust.
Property	N/A	N/A	N/A
Environment	N/A	N/A	N/A

C. OFFICER'S COMMENT

The introduction of third party appeal rights on decisions made by DAPs would enable the Shire to appeal and seek review of DAP decisions that are made contrary to the recommendations of the Responsible Authority Report (RAR) or Council's position.

Development applications determined by Development Assessment Panels in the Shire of Northam, and regional areas, are applications that exceed \$10 million in value and are by nature applications of community interest, such as the Solar Farm, Coles Shopping Centre and the Brethren Church.

At present, Councillors as local government DAP members will sometimes participate in appeal proceedings in their role as a DAP member, which are appeals primarily relating to Applicant's appealing decisions of a DAP where they are dissatisfied with the determination or conditions of an application.

Local government, unless invited by the State Administrative Tribunal (SAT) as a intervenor, cannot participate in appeal proceedings relating to DAP applications. (The role of intervenors is outlined in the SAT Information Brochure – Third Party participation in planning matters attached to this Report (**Attachment 2**).)

The DAP continues its role as the determining authority as provided for in the Regulations in the appeal proceedings resulting in the appeal being determined on the information provided by the Applicant and the Presiding DAP Member supported by the State Solicitor's Officer based on the Responsible Authority Report.

Although it is unlikely that the WA State Government will support the inclusion of third party appeals for DAP decisions, it is recommended that the Shire of Northam support WALGA's original Third Party Appeals Process Preferred Model that includes appeal provisions for local government and does not include "other affected parties", which has not been defined and could result in resourcing and financial implications.

RECOMMENDATION / COUNCIL DECISION

Minute No: C.3860

Moved: Cr Ryan

Seconded: Cr Mencshelyi

That Council advise WALGA that:

- 1. It does not support the proposed amendments to the Third Party Appeals Process Preferred Model, which includes "other affected parties"; and**
- 2. It does support, in principle, the introduction of the ability for local government (only) to appeal the decisions of Development Assessment Panels.**

CARRIED 10/0

Attachment 1



3.9 Third Party Appeal Rights

MOTION

Moved Cr Giorgia Johnson, City of Bayswater
Seconded Cr Julie Mathison, City of Subiaco

IN BRIEF

- Further amendments proposed to the Preferred Model for Third Party Appeals Process

1. That there be an amendment to the Third Party Appeals Process Preferred Model, being that third parties in addition to Local Governments are able to make an appeal.
2. That there be an amendment to the Third Party Appeals Process Preferred Model, being that closely associated third parties in addition to Local Governments are able to appeal decisions made by the Western Australian Planning Commission and the State Administrative Tribunal, in addition to Development Assessment Panels.

CARRIED

MEMBER COMMENT

The Council has taken a particularly strong stand on this important issue and it is requested that this matter be given further consideration.

SECRETARIAT COMMENT

At its May 2019 meeting, WALGA's State Council considered a 'Preferred Model' and resolved that WALGA:

1. Continues to advocate for the State Government to introduce Third Party Appeal Rights for decisions made by Development Assessment Panels, and
2. Endorses the 'Preferred Model' as presented in the May 2019 Agenda, as the Third Party Appeals process for decisions made by Development Assessment Panels and in future give consideration to broadening Third Party Appeal Rights to other parties relating to Development Assessment Panel decisions.

(Resolution 44.4/2019)

The above resolution was sent to the Minister for Transport: Planning with a copy of the proposed model (as attached).

The May 2019 Agenda item sought to finalise a 'Preferred Model' for appeals on Development Assessment Panel decisions. WALGA's State Council considered several alternative WALGA Zone resolutions, as several Zones proposed alternative 'Preferred Models' for decisions made by DAPs, preferred types of Third Party Appeals and one Zone indicated its opposition to any Third Party Appeals model being introduced, as follows: -

SOUTH METROPOLITAN ZONE

That the Position Statement be referred back to WALGA officers to provide an evidence case to support the need for change, the expected benefits, and an analysis of the implications of change in terms of cost, resource and timeframes by utilising the experience of other States where third party appeals exist and applying that to the system proposed.



GREAT SOUTHERN COUNTRY ZONE

That the Zone opposes Third Party Appeals in relation to Item 5.2 in the May 2019 WALGA State Council Agenda.

EAST METROPOLITAN ZONE

That there be an amendment to the Preferred Model, being that third parties are able to appeal decisions made by the Western Australian Planning Commission and the State Administrative Tribunal, in addition to Development Assessment Panels.

CENTRAL METROPOLITAN ZONE

That WALGA:

1. Continues to advocate for the State Government to introduce Third Party Appeal Rights for decisions made by Development Assessment Panels; and
2. Endorses the original December 2018 'Preferred Model' as the third party appeals process for decisions made by the Development Assessment Panels with the following amendments:
 - a. DOT POINT 1 "which could possibly be expanded later if it proves to be beneficial" to be removed
 - b. DOT POINT 4 to be replaced with "Other affected parties would be able to appeal a DAP decision"

Based on the formal resolutions received and members discussions at Zone meetings, there were a range of options available for State Council to consider at its meeting in May: -

1. Not adopt a Preferred Model until more information on cost and resource implications is provided;
2. Adopt the Preferred Model as presented in the May 2019 Agenda;
3. Adopt the Preferred Model as presented in the May 2019 Agenda, with the amendments suggested by the East Metropolitan Zone, ie ability to appeal decisions made by the Western Australian Planning Commission and the State Administrative Tribunal, in addition to Development Assessment Panels;
4. Adopt the Preferred Model as circulated to members in December 2018;
5. Adopt the Preferred Model as circulated to members in December 2018, with the amendments suggested by the Central Metropolitan Zone;
6. Adopt the Preferred Model with different amendments (any amendments discussed by State Council);
7. Not adopt any Preferred Model but still advocate for Third Party Appeal Rights for DAPs decisions
8. Adopt a different Third Party Appeal model (ie wider than just for DAPs);
9. Consult the sector again on what model of Third Party Appeal rights is considered acceptable given the wide range of views;
10. Return to the pre-May 2018 position, where any Third Party Appeal rights are not supported

The preferred approach by State Council was to adopt the Preferred Model as presented in the May 2019 Agenda, as it would provide the starting point for discussion with the State Government about the introduction of Third Party Appeals for Development Assessment Panel decisions.

WALGA provided this position to the Minister for Transport; Planning and the Minister's response was as follows:

I note WALGA's State Council endorsed Preferred Model on this matter, however I maintain concerns regarding the unnecessary complexity and red tape third party appeal rights would add to the



planning system, which is contrary to the objectives of the Government's commitment to planning reform.

The Department of Planning, Lands and Heritage received 254 submissions in response to the Green Paper, including many which confirmed the issues and views identified in the Green Paper regarding the current DAP system.

An Action Plan for planning reform which contains a program of initiatives to address the concerns identified by the Green Paper and submissions is currently being finalised by the Department for consideration by Government.

I will make announcements regarding the content of the Action Plan and reform initiatives in the near future.

UNCONFIRMED



Preferred Model

Third Party Appeal Rights for decisions made by Development Assessment Panels

Benefits of Third Party Appeal Right for decisions made by Development Assessment Panels

- Only Local Governments will be able to challenge and seek review of DAP decisions that are made contrary to the recommendations of the Responsible Authority Report (RAR) or Council position.
- In future, possible consideration to a broadening of Third Party Appeal Rights to other parties relating to Development Assessment Panel decisions.
- Local Government would be able to appeal a DAP decision and defend the merits of their policies and defend the enforceability of their conditions.
- More transparent process in both decision making and condition setting, resulting in more accountable DAP members.

- Would allow for an appeal to be made on the conditions of approval or refusal
 - i) that may have been removed from a RAR; or
 - ii) added to the decision, particularly where no liaison has occurred with the Local Government for clearing or enforcing the condition; or
 - iii) applied inappropriately i.e. the condition would change the intent or design of the development and therefore a new application should have been lodged.

- Limits appeal rights to larger, more complex applications and would filter out 'smaller' impact applications which could potentially overburden the system.
- Provides the opportunity for additional information to be included in the appeal process, particularly if information was not received before the DAP meeting.
- Provides the ability to challenge any new information being presented at the DAP meeting without the Local Government being able to undertake any assessment of the new information (unassessed revised plans are currently being lodged and approved at meetings).
- Able to appeal the 'Deferral' process being over utilised, i.e. DAPs are tending to defer applications multiple times rather than making a decision to approve or refuse the proposal.
- Can give the Local Government more confidence that the developer will provide a fully complete application and discuss the application with the Local Government first, rather than relying on the DAP to condition the proposal requiring additional critical information.



Appellants in a Third Party Appeal

Should be for

- A Local Government where DAP has gone against the position of Council itself; or
- A Local Government where DAP has gone against the Responsible Authority Report (RAR)

Local Government makes a submission

- SAT would need to ensure that appeals are made on valid planning grounds and are not made for commercial or vexatious reasons.
- The existing Directions Hearing process could be used to see if the appeal has reasonable planning merit, which would assist in providing clarity on what constitutes a valid planning consideration and what would be an invalid planning consideration. The Directions Hearing could consider the appellant's justification for submitting the appeal, in particular, whether the grounds of appeal are supported by documentary evidence or other material (a similar process for justifying the lodgement of an appeal already exists through Section 76 of the *Planning and Development Act 2005*).
- *** Will need to discuss with SAT the definition of 'valid planning grounds' to determine whether the submission has reasonable grounds for appeal***

What can be appealed?

- DAP applications that are compulsory over \$10 million for JDAPs and \$20 million for City of Perth DAP; or
- DAP applications in the optional threshold \$2m – 10m for JDAPs and in the City of Perth \$2 million - \$20 million; or
- DAP applications seeking amendments to approvals *i.e.* Form 2 applications proposing a change to the development application, and including applications for an extension of time

Timeframe to lodge an appeal

- As per the existing timeframe, an appeal on a decision made by a Development Assessment Panel should be lodged within 28 days of the decision being made public, ie publishing of the DAP minutes.
- Local Governments would need to determine within their own organisation what process to follow in order to decide whether or not to lodge an appeal against a DAP decision. In many cases this may require a Special Council meeting to determine this.

Costs

- Any Local Government would need to cover their costs of initiating the appeal, attending SAT directions, mediation and hearings, and costs could also include obtaining expert advice.



Appeals Process

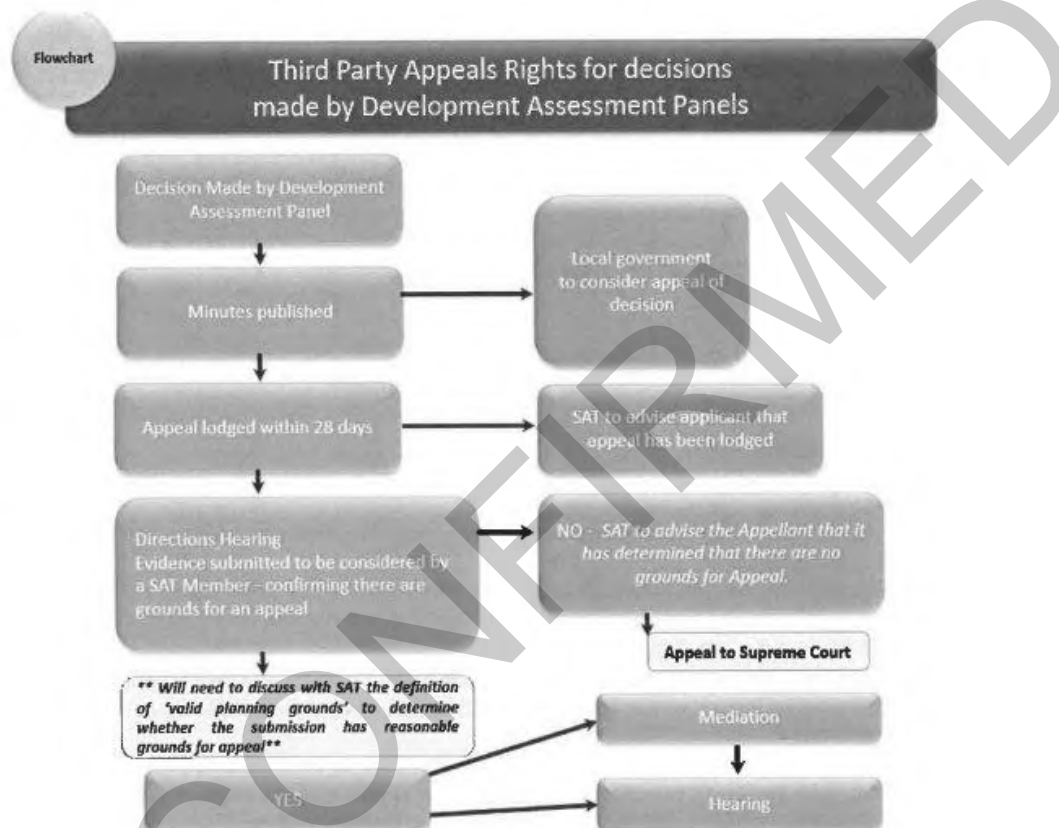

Attachment 2

- SAT must determine that it is appropriate to allow the third party to intervene having regard to the considerations described above in relation to when SAT may allow a third party to make submissions under section 242 of the *Planning and Development Act 2005* and any other relevant consideration.

A third party who wishes to intervene should write a letter to SAT dealing with these points and send a copy of the letter and any supporting documents to each of the parties. SAT will usually hold a directions hearing to determine whether to allow the third party to intervene at which the third party and each of the parties may attend and explain their positions.

Can a third party participate in mediation?

The purpose of mediation is to resolve a dispute by settlement between the parties or to narrow the issues in dispute. Mediation is usually a private and confidential process involving the parties only.

A third party may usually only participate in mediation if the parties agree. Sometimes the parties agree to a third party participating to a limited extent by explaining their concerns or by providing technical information not otherwise available. In rare cases, SAT may override the wishes of the parties and allow a third party to explain their concerns or participate in some other way.

A third party should usually first speak to the respondent or their representative if they wish to participate in a mediation. If a third party wishes to ask SAT to allow them to participate in a mediation, they should do so at the directions hearing at which the matter is referred to mediation or by letter to SAT with copies to the parties, not at the mediation itself.

For further information about directions hearings and mediations see SAT's pamphlets *Information about class 1 planning applications* and *Information about class 2 planning applications*.

What is a third party's role if the respondent is invited to reconsider its decision?

As a result of mediation the applicant may provide additional information or clarification to the respondent about a planning application or may ask SAT for permission to amend the application. In such cases, SAT often invites the respondent to reconsider its decision under section 31 of the *State Administrative Tribunal Act 2004* having regard to the additional information or clarification or the amended application.

If SAT invites the respondent to reconsider its decision, then a third party should direct its submissions to the respondent as the respondent has power to make another decision.

For further information about an invitation to reconsider a decision see SAT's pamphlet *Section 31 invitation by SAT for decision-maker to reconsider its decision*.

Further information

For further information about planning matters see SAT's pamphlets—

- *Information about class 1 planning applications*
- *Information about class 2 planning application*
- *Documents that may be required by SAT in planning applications*
- *Section 31 invitation by SAT for decision-maker to reconsider its decision*

These pamphlets are available on the development and resources page of the SAT website www.sat.justice.wa.gov.au or by telephoning SAT on (08) 9219 3111 or 1300 306 017 (country callers).

The SAT website also has a searchable decisions database including decisions concerning third party participation.



State Administrative Tribunal
Western Australia

Third party participation in planning matters

Contact us

Address: State Administrative Tribunal
Ground Floor,
12 St Georges Terrace
Perth, WA 6000

Postal address: GPO Box U1991
Perth WA 6845

Phone: (08) 9219 3111 or 1300 306 017

Fax: (08) 9325 5099

Email: info@sat.justice.wa.gov.au

Website: www.sat.justice.wa.gov.au

Purpose of this pamphlet

This pamphlet explains how a person who is not an applicant or a respondent can participate in a SAT planning matter. Such a person is known as a "third party". The applicant and the respondent are together known as "the parties". This pamphlet is designed for general guidance only and is **not a substitute for legal advice**.

Can a third party appeal to SAT?

There are generally no third party appeal rights in relation to planning decisions in Western Australia. Unless a local planning scheme or local law allows a third party to apply to SAT for review of a decision, only the applicant for planning approval or a person to whom a direction or notice is given by a planning authority may appeal to SAT.

Can a third party be joined as a party?

Under section 243 of the *Planning and Development Act 2005* SAT's general power to join a person as a party to a proceeding under section 38 of the *State Administrative Tribunal Act 2004* is **excluded** in planning matters.

In applications **not** under the *Planning and Development Act 2005* SAT may join a person as a party if it considers that—

- the person ought to be bound by, or have the benefit of, SAT's decision in the proceeding;
- the person's interests are affected by the proceeding; or
- for any other reason it is desirable that the person be joined as a party.

Are there other ways in which a third party may participate?

There are four ways in which it **may** be possible for a third party to participate in a planning matter. These are—

- being called as a witness by the respondent;
- making submissions under section 242 of the *Planning and Development Act 2005*;

- intervening under section 37(3) of the *State Administrative Tribunal Act 2004*; and
- possible participation in mediation.

Each of these possibilities is discussed in this pamphlet.

Called as a witness to give evidence

The usual way in which a third party participates in a planning matter is by being called as a witness to give evidence at the hearing on behalf of the respondent. A third party should usually first speak to the respondent or its representative if they wish to give evidence.

Anyone giving evidence to SAT usually needs to prepare a witness statement of their evidence. A written submission made to the respondent may be accepted as a witness statement if it contains all of the evidence the person wishes to give and if the respondent makes it clear to SAT and the applicant when the respondent is required to file witness statements that it relies on the submission as a witness statement. Anyone giving evidence must come to the final hearing to answer any questions from SAT or the parties or their representatives.

For further information about witness statements and what happens at a final hearing see SAT's pamphlets *Documents that may be required by SAT in planning applications*, *Information about class 1 planning applications* and *Information about class 2 planning applications*.

Making submissions

SAT may allow a third party who has a sufficient interest in the matter to make submissions in respect of a planning application under section 242 of the *Planning and Development Act 2005*. In order for SAT to allow a third party to make submissions—

- the third party must have a legal interest or some other direct, material and special interest in the outcome of the application that is unique to it and not shared by the public generally or a segment of the public; generally it is not sufficient that the third party holds genuine and strong views or has taken an active interest in relation to the matter

even where the third party is a body such as a community association that has objects directed to promoting outcomes relevant to the application; and

- SAT must determine that it is appropriate to allow the third party to make submissions in respect of the application having regard to considerations such as—
 - the nature and strength of the third party's interest;
 - the contribution that the third party is likely to be able to make to the proper resolution of the issues;
 - whether the interest which the third party represents and the matters they intend to address will be adequately dealt with by the parties;
 - the impact on the conduct of the application, the interests of the parties and the public interest in the prompt and efficient finalisation of the application; and
 - SAT's main objectives described in section 9 of the *State Administrative Tribunal Act 2004* including "to act as speedily and with as little formality and technicality as is practicable, and minimise the costs to the parties".

A third party who wishes to make submissions should write a letter to SAT dealing with these points and send a copy of the letter and any supporting documents to each of the parties. SAT will usually hold a directions hearing to determine whether to allow the third party to make submissions at which the third party and each of the parties may attend and explain their positions.

If SAT allows a third party to make submissions, then it will usually require the submissions to be in writing and filed with SAT and provided to the parties in advance of the hearing so that the parties can address the submissions at the hearing.

The status of a submission-maker does not give the third party the right to give evidence, call witnesses, ask questions of witnesses or appeal against SAT's decision.

If the parties reach agreement in relation to the resolution of the application and ask SAT to make orders by consent to give effect to their agreement, then SAT will usually not allow a third party to make submissions in relation to the application.

Intervention

SAT may allow a third party to intervene in a planning matter under section 37(3) of the *State Administrative Tribunal Act 2004*. If SAT allows a third party to intervene, then the third party acquires rights and responsibilities as a party under s 36(1) of the *State Administrative Tribunal Act 2004*. But SAT may impose conditions on an intervention. Usually an intervener may give evidence, call witnesses, ask questions of witnesses and exercise any appeal right available to a party.

In order for SAT to allow a third party to intervene—

- the third party must have at least a sufficient interest in the matter to make submissions under section 242 of the *Planning and Development Act 2005* as described above. However, merely demonstrating a sufficient interest does not by itself entitle a right to intervene;
- there must be something about the particular circumstances of the case which makes it necessary, in order for SAT to reach the correct and preferable decision, that the third party should be allowed to intervene;
- the third party will generally need to demonstrate that its intervention is necessary to enable SAT to meet its main objectives described in section 9 of the *State Administrative Tribunal Act 2004* and the purposes of the *Planning and Development Act 2005* described in section 3(1) of that Act;
- generally the third party must not simply seek to argue for or against the application on the same basis as an existing party; and

Mr C B Hunt declared an "Impartiality" interest in item 12.3.5 - Request for Quotation for Waste Collection Services in the Shire of Northam and Avon Regional Organisation of Councils as the Directors/owners of Avon Waste are known to him. He was not involved in the assessment process or recommendation report.

12.3.5 Request for Quotation for Waste Collection Services in the Shire of Northam and Avon Regional Organisation of Councils

Address:	Shire of Northam
Owner:	Shire of Northam
File Reference:	4.1.1.9
Reporting Officer:	Carmen Sadleir, Manager Health and Environment
Responsible Officer:	Chadd Hunt, Executive Manager Development Services
Officer Declaration of Interest:	Nil
Voting Requirement:	Simple Majority
Press release to be issued:	No

BRIEF

Council is requested to consider quotations submitted through the Western Australian Local Government Association's (WALGA) Vendor Panel for waste collection services.

ATTACHMENTS

Attachment 1: WALGA Recommendation Report for the 'Request for Quotation' (RFQ 05/19) for the Avon Regional Organisation of Councils (AROC) Waste Services. (SEPARATE CONFIDENTIAL ATTACHMENT).

A. BACKGROUND / DETAILS

The Shire of Northam's waste collection contract with Avon Waste expires on 30 June 2020 and as the cost of the contract is greater than \$150,000 in value, the Shire will be required to enter into a new contract with a suitably qualified service provider.

The Shire of Northam has joined together with 5 of the 6 Avon Regional Councils to improve the attractiveness of the contract for waste service providers, potentially resulting in a lower price for the services.

In the previous waste collection service contract the Shire of Northam and Toodyay entered into a joint procurement process to use the aggregate number of collection services to assist in obtaining the best pricing possible. The success of this procurement method was demonstrated, as it resulted in Council saving approximately \$40,000 per annum for waste collection services.

Given the success of the above process Council and four other local authorities within AROC (Toodyay, York, Victoria Plains and Dowerin) opted to undertake a joint procurement process for waste services for the next 5 years with an extension option of 4 years (2 x 2 year) and have engaged WALGA to manage the procurement process. The pricing was sought on the basis of a joint price (all local authorities together) and individual local government pricing. A 'Request for Quotations' from experienced waste collection service providers have been sought through the WALGA Vendor Panel and two submissions have been received.

B. CONSIDERATIONS

B.1 Strategic Community / Corporate Business Plan

Theme Area: Environment and Heritage

Outcome 4.3: Residents and organisations within the Shire of Northam are supported to reduce their environmental impact.

Objective: Sustainable waste management with the aim of reducing and reusing waste effectively.

Strategic Waste Minimisation Plan 2015-2020 – Avon Regional Organisation of Council

Proposed Plan Activity Table

No.	Activity	Implementation Solution
11	Investigate benefits for joint tendering.	Procure services jointly for the AROC group.

B.2 Financial / Resource Implications

Council currently has sufficient budgeted funds to cover the cost of the waste collection contract.

Currently the cost of Council's Waste Collection Service is approximately \$934,797 per annum (including street bin collection, bin replacement/maintenance and calendars). More detailed analysis of the tender is included in the Officers comment section of this report.

B.3 Legislative Compliance

Section 3.57 Tenders for Providing Goods or Services of the Local Government Act 1995 states-

- (1) A local government is required to invite tenders before it enters into a contract of a prescribed kind under which another person is to supply goods or services.
- (2) Regulations may make provision about tenders.

Section 11(2) of the Local Government (Functions and General) Regulations 1996 states, tenders do not have to be publicly invited according to the requirements of this Division if —

- (b) the supply of the goods or services is to be obtained through the WALGA Preferred Supplier Program.

B.4 Policy Implications

The procurement of waste collections services for the Shire of Northam complies with Council's Policy F4.2 Purchasing and Tendering.

B.5 Stakeholder Engagement / Consultation

The RFQ was made available to all waste collection preferred suppliers on the WALGA vendor panel.

Discussion and agreement has been reached by those participating member Councils of AROC to proceed with a joint procurement process. All AROC member Councils involved in the procurement process have been issued with a copy of the recommendations report and pricing schedule.

B.6 Risk Implications

Risk Category	Description	Rating (consequence x likelihood)	Mitigation Action
Financial	The proposed RFQ submissions are within budget.	Moderate (5)	Nil
Health & Safety	Injury to the public or contractors.	Moderate (5)	WALGA panel suppliers have been vetted for suitable experience. Both submissions had occupational health and safety policies and practices.
Reputation	Should the waste service not be delivered to the	Moderate (8)	WALGA panel suppliers have been vetted for

	community adequately this could affect the Shire's reputation.		suitable experience.
Service Interruption	Should the waste service not be delivered to the community adequately this could affect the Shire's reputation.	Moderate (6)	WALGA panel suppliers have been vetted for suitable experience. Contractors new to the area have addressed the need for a changeover plan if required.
Compliance	Services are required to be procured in accordance with policy and legislation.	Moderate (8)	By undertaking the RFQ process through the WALGA Preferred Supplier Panel the Shire is complying with its statutory obligations.
Property	Damage to Council property such as poor bin handling processes.	Moderate (5)	WALGA panel suppliers have been vetted for suitable experience.
Environment	Poor collection or disposal methods could result in damage to the environment.	Low (4)	WALGA panel suppliers have been vetted for suitable experience.

C. OFFICER'S COMMENT

In response to the WALGA Vendor Panel Preferred Supplier advertised RFQ two submissions were received from the following proponents:

1. Cleanaway Pty Ltd
2. Stondon Pty Ltd Trading as Avon Waste

These submissions were assessed against the predetermined procurement criteria as included within Attachment 1 the:

- | | |
|---|------------|
| 1. Compliance Criteria (Yes or No response) | Scored (%) |
|---|------------|

(a) Respondents Profile;	40
(b) Conditions of Quote;	
(c) Pricing;	
(d) Risk Assessment;	
2. Qualitative Criteria	Scored (%)
(a) Relevant Skills and Experience to Deliver the Requirements of the Contract;	20
(b) Understanding of Operational Requirements and Plans to Deliver the Service;	35
(c) Corporate and Social Responsibility.	5

The assessment determined the ranking of the tenders as indicated below:

- 1st Stondon Pty Ltd Trading As Avon Waste
- 2nd Cleanaway Pty Ltd

The AROC procurement has utilised the economy of scale by combining all the services within the AROC area (except the Shire of Goomalling) for the RFQ, however each Council has also been provided with separate costings and contracts should a joint procurement not be undertaken. This process has produced very competitive quotations for all Local Governments involved and undertaking a joint tender is also an outline activity in the AROC Strategic Waste Minimisation Plan 2015- 2020.

The costing in the RFQ will result in savings of approximately \$55,000 per annum for the Shire of Northam from current costings should the joint procurement process be undertaken. Should however a joint process not be entered into the cost to Council could increase up to \$906,878.24 depending on the successful submission. For further details on the pricing analysis please refer to pages 11 and 12 of the WALGA Recommendation Report for the 'Request for Quotation' (RFQ 05/19) for the Avon Regional Organisation of Councils (AROC) Waste Services. (SEPARATE CONFIDENTIAL ATTACHMENT).

The procurement process required contractors to submit pricing for each local government to be serviced autonomously and then again as part of the combined AROC group, however still with individual Council pricing. An alternate pricing option was submitted by one respondent which is included within the recommendation report (refer to page 12). Staff can provide further explanation of this proposal at the Council meeting.

The Shire of Northam's current kerbside rubbish collection service picks up mobile garbage bins (MGB's) from approximately 88% of properties with houses located on them. The proposed contract specification includes two minor service extensions where it has been identified as being economically

viable to extend the collection. These service extensions include an 8km continuation along Clydesdale Road which will collect an additional 5 houses and 17km one way route extension along Grass Valley North Road, which will collect an additional 14 houses.

The contract specification will also now include the collection all parks and gardens, street (including regional and Northam town) bins and annual recycling calendar printing costs and waste education services.

Based on the procurement assessment in accordance with the predetermined selection criteria, the contract is recommended to be awarded to Avon Waste for the value of \$879,100.10 per annum.

RECOMMENDATION / COUNCIL DECISION

Minute No: C.3861

Moved: Cr Tinetti

Seconded: Cr Mencshelyi

That Council:

- 1. Awards the request for quotation made available through the WALGA preferred suppliers to Avon Waste for the provision of Waste and Recycling Collection and Bulk Rubbish Services, up to the value of \$879,100.10 for a period of 5 years commencing from July 1, 2020 until 30 June 2025, with the option to extend for a further 4 years (2 x 2 years) at the Principals discretion; and**
- 2. Authorises the Chief Executive Officer to execute the contract, subject to any variations (of a minor nature).**

CARRIED 10/0

12.3.6 Corella Management

Address:	Shire of Northam
Owner:	Various
Applicant:	N/A
File Reference:	3.1.8.13
Reporting Officer:	Chadd Hunt Executive Manager Development Services
Responsible Officer:	Chadd Hunt Executive Manager Development Services
Officer Declaration of Interest:	As the proposed location for the trapping is on the Northam Country Club land the Executive Manager Development Services is on the Board of the Country Club
Voting Requirement:	Simple Majority
Press release to be issued:	Yes

BRIEF

Council is requested to endorse the management of corellas within the Shire of Northam which includes undertaking culling by licenced and experienced contractors.

ATTACHMENTS

Attachment 1: Information sheet prepared by the Department of Biodiversity, Conservation and Attractions.

A. BACKGROUND / DETAILS

The Butlers Corella (*cacatua pastinator butleri*) Western or long billed Corella (*cacatua pastinator derbyi*) commonly referred to as white cockies) have over recent years caused damage and nuisance within the Shire of Northam. The issue is obviously not isolated to the Shire however a number of other local authorities have developed a management plan in order to assist with the control of the birds in their local area.

Council has previously obtained a licence from the (then) Department of Parks and Wildlife to control/scare birds in 2015. However due to restrictions regarding the use of firearms this proved difficult to implement.

Since then various attempts have been made to manage the Corella issue with limited success. Most recently Ranger Services and some Parks and

Gardens staff have used various methods (including starting pistols) to disturb the nesting of the corellas but these have not been successful.

A report was considered by Council at its strategic meeting held in May 2018 where the option of preparing a corella management strategy was generally agreed to as per the below extract from the meeting notes –

The general consensus of the Council was that this issue warranted further investigation which is to be undertaken in the context of the work already undertaken by WALGA and the City of Geraldton.

Since that meeting the regulations regarding the protection of the corellas has changed significantly and hence the need for a specific management plan has been reduced. It is proposed that following the trial (if approved) a basic management plan/operating procedure will be prepared.

Council considered a report on the management of corellas at its meeting held on 15th May 2019 where an alternate resolution was made to the officer's recommendation as follows-

That Council defer the decision on corella management to allow discussion with other local government authorities in the region, with the intended outcome being a collaborative, sustained regional approach to corella management.

Following that resolution various attempts have been made to coordinate a regional approach to the management of corellas with the AROC and surrounding shires with little success. There has been general support for a regionally collaborative approach however there has been no plans or strategies put in place.

In this regard the Avon Regional Organisation of Councils (AROC) considered the matter at its meeting held on 2nd December 2019 where it resolved the following

That the Shire of Goomalling gather latest research and bring back to the next CEO and then President's meeting.

Council in adopting the 2019-20 Budget included an allocation for corella management (\$11,000). Some preliminary additional work has been undertaken regarding potential "scare" mechanisms which aims to protect key infrastructure such as playing fields.

In addition there has been little progress with respect to the WALGA work, with several other local authorities proceeding with the culling option.

B. CONSIDERATIONS

B.1 Strategic Community / Corporate Business Plan

Theme Area 5: Infrastructure & Service Delivery.

Outcome 5.2: Environmental risks are proactively managed to minimise impact on residents.

B.2 Financial / Resource Implications

There will be an initial cost to Council of up to \$11,000 to contract out the corella culling. As indicated elsewhere in this report depending on the success of the trial an annual allocation may be required.

There will be some staff time involved in feeding the birds at the nesting site however considerable cost is already expended by Council in terms of staff time in attempting to move the birds on and in repairing damage and mess caused by the birds.

B.3 Legislative Compliance

The control of the corellas is controlled under the Biodiversity Conservation Act 2016 and Regulations 2018.

The regulations have included the Butlers Corella, Western Corella and Eastern long billed corella as a “Managed Fauna” for the purposes of the Act, meaning that they are able to be taken within a “Managed Area”, the Shire of Northam is included within the “Managed Area” definition for all three species within the Regulations.

B.4 Policy Implications

There is no applicable policy.

B.5 Stakeholder Engagement / Consultation

Initial stakeholder consultation has been limited to other local authorities that have prepared similar strategies and the WALGA coordinated Corella Control Program (currently based in the Perth Metropolitan Area).

Initial discussion have been held with the owner of the land proposed for the trapping, the Northam Country Club, and they have been supportive of the proposal.

B.6 Risk Implications

Risk Category	Description	Rating (likelihood x consequence)	Mitigation Action
Financial	The risk is moderate given that it is	Moderate(6)	If it is successful there may be an

	unknown how successful it will be	(Possible/Minor)	ongoing recurrent cost for Council on annual basis.
Health Safety &	There is risk to the general public with any culling activities	Moderate(8) (Likely/Minor)	The use of a licenced and experienced contractor will help mitigate the legal concerns with the proposal. In addition it is proposed that any trapping and culling be undertaken on private land
Reputation	There is a risk to the organisations reputation if additional active mechanisms are not undertaken to control the corellas. The attempted "moving on" of the birds have not been successful and if Council does not take any further action it could be deemed to be not acting on There is also a reputation risk to Council with respect to the undertaking of culling animals generally including animal welfare issues.	High(12) (Likely/Medium) Moderate(9) (Possible/Medium)	The risk is mitigated by undertaking various control options as highlighted in this report This risk is mitigated by ensuring any culling activity is undertaken by experienced and licenced contractors in accordance with

			established guidelines in a humane manner
Service Interruption	Nil.		
Compliance	Non Compliance with current legislation	Moderate(6) (Possible/Minor)	The management of corellas has been controlled through the Department of Parks and Wildlife. Currently permits are no longer required to trap or destroy corellas.
Property	Damage to critical infrastructure is currently being caused by the corellas.	High(12) (Likely/Medium)	Undertaking "scare" tactics and culling should assist in protecting that infrastructure.
Environment	Damage to the Environment caused by excessive numbers of corellas	High(12) (Likely/Medium)	Undertaking control mechanism should reduce the impact on the local environment

OFFICER'S COMMENT

The proliferation of the corella has caused significant damage to playing surfaces, native vegetation and physical infrastructure (such as the CCTV network with damage costing 20k). Previous attempts at relocating them have not been successful and staff are of the opinion that culling, in association with other control measures is the only viable alternative. The engagement of a suitably qualified, experienced and insured contractor is seen as being the most practical and safe option to pursue.

The undertaking of a regional coordinate approach is seen as a sound long term solution however staff are concerned that delaying any action whilst waiting for the regional approach will result in the problem escalating.

RECOMMENDATION / COUNCIL DECISION

Minute No: C.3862

Moved: Cr Ryan
Seconded: Cr Della

That Council

- 1. Resolves to authorise the commencement of an annual culling program for the Butlers Corella within the Shire of Northam in accordance with provisions of the Biodiversity Conservation Act 2016 and Biodiversity Conservation Regulations 2018.**
- 2. Continues to support a regionally collaborative approach to the management of corellas through AROC.**

CARRIED 8/2

Debate was held around the motion. Cr Ryan, Cr Della, Cr Tinetti and Cr Little spoke for the motion. Cr Williams spoke against the motion. Cr Ryan used his right of reply to close the debate.

Attachment 1



Department of Biodiversity,
Conservation and Attractions

FAUNA NOTES

Corellas and Other Flocking Cockatoos

Identification, Distribution and Behaviour

There are a variety of corellas and other flocking cockatoos that are native to Australia, but not all of these naturally occur in Western Australia. The western corella *Cacatua pastinator* is one of the species endemic to WA, and is made up of two subspecies: Muir's corella *Cacatua pastinator pastinator* and Butler's corella *Cacatua pastinator butleri*. Muir's corella was once widely distributed across WA but is now confined to small areas around Bridgetown and Manjimup. Butler's corella occur in the northern Wheatbelt and their range has expanded considerably since the establishment of crops and farm dams in this region. Two subspecies of the little corella, *Cacatua sanguinea westralensis* and *Cacatua sanguinea sanguinea*, naturally occur in the Pilbara and Kimberley regions of WA. Refer to www.naturemap.dpaw.wa.gov.au to find further information on the species distribution.

Several cockatoo species that are native to Australia, including the eastern long-billed corella *Cacatua tenuirostris* and eastern subspecies of the little corella *Cacatua sanguinea*, have become established in WA, despite not naturally occurring in the state. They have expanded their range through much of the Perth metropolitan area and regional towns in the past 20 years. A field guide for Australian birds can be used to differentiate between the different species of corellas and flocking cockatoos.



Eastern long-billed corellas (top) and a little corella (bottom). Photos: R. Kirkby.

Corellas and other flocking cockatoos opportunistically search for food resources, feeding on grass seeds and bulbs in paddocks and other grass areas in the spring, wheat stubble remaining after harvest in the summer, and grain from stock feed troughs, animal dung and hay bales in the late summer and autumn. They roost at night in trees in large flocks. During breeding season, pairs nest in tree hollows, laying 2-3 (occasionally 4) eggs from July to October. Parents share the incubation duties and care of the young while the nestling remains in the hollow for approximately 7 weeks. After fledging, young birds and their parents join a large nomadic foraging flock.

The information provided does not apply to the three threatened black cockatoo species. Further information on these species is available on the species webpage and information sheets on the Department's website.

Environmental Law

All fauna native to Australia are afforded protection under both State and Commonwealth legislation. Muir's corella *Cacatua pastinator pastinator* is listed as fauna that is Conservation Dependent (Specially Protected) under Western Australian legislation.

Depending on the type of fauna-related activity, a licence issued by the Department of Biodiversity, Conservation and Attractions may be required. It is an offence to intentionally or recklessly kill, injure, trade, keep or move them unless authorised by a permit. To obtain a licence, the applicant needs to demonstrate that all reasonable non-lethal methods have been attempted and environmental impacts have been assessed. Further information is available on the Department's [website](#).

Import Restrictions

Sulphur crested cockatoos and little corellas may only be imported into WA under permit and strict conditions. Importation is prohibited except where the bird is a family pet that has been owned for 2 years and the owner is permanently moving to the state. The owner must demonstrate that these criteria have been met via a statutory declaration. The bird may not be sold or given away once in WA, and strict keeping conditions must be adhered to.

FAUNA NOTES – Corellas and Other Flocking Cockatoos

Impacts to Biodiversity

The biodiversity impact of introduced corellas and other flocking cockatoos in south-west WA is difficult to quantify. The damage they cause to trees is a long term issue, particularly for trees that are potential nest sites for other species including the three Threatened black cockatoo species. They are also significant competitors for nesting hollows with black cockatoo species and other native hollow nesters (parrots, owls, raptors and some duck species). Corella species have also been recorded hybridising in the wild and this loss of genetic purity between the species and subspecies is considered a threatening process to WA's endemic native corellas and cockatoos.

Corella-Human Interactions

Large flocks of corellas and other cockatoos make a large amount of noise when attracted to feeding sites and congregating at roost sites, and droppings can foul trees, washing on clothes lines, buildings, recreational areas and vehicles. Flocks can also cause damage to the grass surfaces of sport fields and golf courses when they are digging for corns, bulbs and roots. Natural branch trimming behaviour while roosting can affect the health of trees when the behaviour is repeated in the same trees over time, and can lead to an increase in park and street maintenance costs. Corellas will also use artificial structures, such as telecommunication towers, as temporary roost sites and will often damage the cabling and other fixings while chewing to maintain their bills. The additional repair costs can be high for the communication operators, and ultimately the customers using those services. Corellas and other flocking cockatoos can also cause damage to homes when chewing on light fittings, aerials and roofing materials. Some of these nuisance problems originate from people deliberately feeding the birds. This is strongly discouraged. There is additional information about the negative impacts of [feeding wild animals](#) on the Department's website.

Corellas and other flocking cockatoos can also be a nuisance in agricultural areas, as they will dig up newly planted seeds of wheat and oats and feed on grain supplied for stock during the summer and autumn periods. Growers should be prepared for peak periods of activity, and should aim to address the problem before the corellas develop a habit of feeding on the crop. Corellas have also been recorded pulling up or cutting down the seedlings of blue gums, lettuce, cabbage and other root vegetable crops. They can also damage reticulation systems used for intensive horticulture. However, it should not be assumed that crops have been damaged just because birds are present. Crops should be checked for visible signs of damage, and they should be monitored throughout the region.

If you find a sick or injured corella or cockatoo contact the [Wildcare Helpline](#) on (08) 9474 9055 for information on registered wildlife rehabilitators.

Disease Risk

Like other wildlife, corellas and other flocking cockatoos can carry bacteria and viruses. Psittacosis and Chlamydia are diseases that are common in parrots and can be passed onto human through bites, scratches, contact with faeces and inhalation of feather dust. The risk of infection can be managed by following proper handling procedures, which includes wearing appropriate personal protective equipment.

Damage Prevention and Control

The key to minimising damage by corellas and other flocking cockatoos is to understand their behaviour patterns. Flocks will use regular flight paths and roost sites and will repeatedly return to favourable feeding sites. They will also opportunistically join other flocks that they see feeding. Effective damage control programs are well planned, based on an understanding of the behaviour of the birds, varied frequently, integrated with a number of different methods and persistent.

Fertility control and the use of poisons or anaesthetics are considered ineffective, impractical and inhumane methods of damage control, and the use of these methods can also present a significant risk to non-target animals. The most effective damage control methods involve limiting access to food, scaring techniques and, in some cases, population control by shooting or trapping. Ideally, one or more control measures should be undertaken before a flock becomes established in an area. The effectiveness of measures can decrease over time, as cockatoos have been known to habituate to many strategies that are employed consistently.

Limiting Access

Visual screens can be used to protect and hide newly planted seedlings, materials, small playing fields, fruit and nut orchards, vegetable crops, feed and water troughs, hay stacks and silage covers. Corellas like to have a clear view

FAUNA NOTES – Corellas and Other Flocking Cockatoos

when they are feeding, so visual screens can also make a feeding location unattractive to them.

- For newly planted seedlings, erect a screen 0.6-1m high. The screen can be a fence lined with hessian or shade cloth, or rows of native vegetation and/or tall grass. Direct seeding may also reduce the risk of plants being uprooted by the birds.
- Cover materials, such as timber, with metal or shade cloth.
- For small playing fields, such as bowling greens, erect a 2.5m high removable screen made of shade cloth or hessian.
- For orchards and crops, erect a 2.5m high visual screen of shade cloth around the crops. Netting the orchard or crops to exclude the birds may also be cost effective, particularly in areas adjacent roost sites.
- For food and water troughs, place a hood over the trough or erect shade cloth screen on three sides and above the trough.
- For hay bales and stacks, erect 2.5m high walls of shade cloth around the hay. Chicken wire can also inhibit corellas from attacking any but the outermost bales of a haystack.
- For silage covers, erect 2.5m high shade cloth or hessian walls to prevent cockatoos from perching and perforating the covers with their powerful bills.

Minimising the amount of food available in agricultural areas will help to decrease the overall corella population size, as their survival rates are linked to food availability. It is important for all farmers in an area to sow at the recommended rate, cover all grain and clean up spills, minimise residual grain in stubble, and direct drill and sow at the same time as neighbours. Locating crops away from watering points and roosting trees may also reduce the impacts of birds. Feed trails for stock should be placed out late in the day when cockatoos are returning to the roosts to allow the stock to feed through the night undisturbed. The aim should be to release just enough grain so that little residue remains in the morning. Young cockatoos are attracted to the undigested grain in cattle droppings, so regularly clear up droppings in feed lots. Removing particular plants that corellas like to feed on, such as onion grass, from agricultural areas, playing fields and other recreational areas will also make a site less attractive to the corellas.

In areas where buildings and fixtures are prone to damage by cockatoos, prudent design and material selection can prevent damage. Using hardwood or metal fixings instead of timber and replacing loose roofing nail with roofing screws will prevent damage by cockatoos. In extreme circumstances, power lines can be laid underground to prevent damage to cabling. Installing commercial wires and spikes and encasing light fittings, cables and aerials with a rotating PVC or poly-pipe can be a useful tool for preventing birds from perching and damaging homes.

Scaring Techniques

Effective scaring and decoy campaigns aimed at disturbing a cockatoo roost can often move the problem onto a neighbour who has not been employing the same level of control measures. Therefore, it is important that control programs are implemented community-wide to adequately address the problem on a larger and long-term scale. Switching between different scaring methods, and changing how the method is employed, will reduce the likelihood of the birds becoming accustomed to the techniques.

A combination of pyrotechnic cartridges and taped alarm calls, with spotlights at night roosts, is the most effective method from deterring birds from roosts. It may take a week or more for this control program to move the flock to another roost. This method requires public notification and careful management in rural towns and urban areas, as this level of noise may disturb in more heavily populated areas.

Manual scaring techniques like pyrotechnic cartridges can be expensive and time consuming, often required a farmer growing a rotation of summer and winter crops to devote 4-6 hours a day over 6-8 weeks. An alternative that is commonly used to scare flocks of birds is gas guns. They should be set to operate at long intervals, and only used when the birds are feeding on the crop early and late in the day. Gas guns are most effective if hidden by hides and should be moved every two or three days. They should also be moved out of sight when not in use.

Corellas and cockatoos are scared by birds of prey. Kites that simulate birds of prey may be effective for small paddocks but they should be shifted often.

Some potential exists to lure a flock of birds away from high value crops by supplying abundant food in an alternative location. Some farmers plough an area to expose onion grass corms to lure birds to an alternative site while sowing.

The lure should be placed at least 500m away so that scaring techniques being employed at the crop site does not

FAUNA NOTES – Corellas and Other Flocking Cockatoos

disturb the birds at the decoy site. The most effective decoy sites are those under flight paths and near trees that can be used for perching or roosting.

Population Control

Population control using lethal methods should be viewed as a last resort after all other control options have been attempted. Guidelines for approved control techniques for introduced corellas can be obtained from Parks and Wildlife upon request.

The Department has previously trialled programs to control introduced corellas in the Perth metropolitan area, and trapping has proved to be the most effective means of removing over-abundant birds and breaking up large flocks habitually feeding in an area. Trapping programs rely on understanding the daily and seasonal movements of the flocks, including knowledge of feeding habits, the number of flocks, flock structure, the presence of non-target species, roosting locations and flight paths. Such information must be determined prior to undertaking a trapping program.

Most of the introduced corella species prevalent in the Perth area usually feed in the open in public space, so trapping using walk-in cage traps will have limited use and may be difficult to manage due to interference from vandals or other members of the public. For these reasons, trapping is best applied using nets at a control site that does not have public access. Trapping must only be undertaken by fully trained and qualified personnel, and must be conducted under the conditions of a licence obtained from the Department.

It can be difficult to manage the efficient, humane and safe disposal of trapped birds, so trapping activities must be controlled through the use of specific and clear operating protocols and management procedures. Any non-target species that are trapped must be released unharmed as soon as possible, and birds must not be excessively distressed or injured in the process of trapping. Any suffering must be alleviated as quickly as possible. Frightened corellas will injure themselves and other birds, so they must be euthanased as quickly and humanely as possible after trapping.

When using a trap, shooting using a low powered licenced firearm is the most practical, quick and effective means to humanely euthanase an animal. Local police in the relevant area should be informed in advance and written permission must be obtained from the owner or occupier of the property prior to any control actions being undertaken. The reaction of members of the public should also be considered when selecting a trapping site and undertaking trapping and euthanasia methods.

Citation

Department of Biodiversity, Conservation and Attractions. (2017). *Fauna Notes – Corellas and Other Flocking Cockatoos*. Retrieved from <http://www.dbca.wa.gov.au/>

Disclaimer

The State of Western Australia and its employees do not guarantee that this publication is without flaw of any kind or is wholly appropriate for your particular purposes and therefore disclaims all liability for any error, loss or other consequence that may arise from you relying on any information in this publication.

For more information see the department's
website www.dbca.wa.gov.au



Department of Biodiversity,
Conservation and Attractions

12.4 CORPORATE SERVICES

12.4.1 Accounts & Statements of Accounts – December 2019

Address:	N/A
Owner:	N/A
Applicant:	N/A
File Reference:	2.1.3.4
Reporting Officer:	Kathy Scholz, Creditors Officer
Responsible Officer:	Colin Young, Executive Manager Corporate Service
Officer Declaration of Interest:	Nil
Voting Requirement:	Simple Majority
Press release to be issued:	No

BRIEF

For Council to receive the accounts for the period from 1 December 2019 to 31 December 2019.

ATTACHMENTS

Attachment 1: Accounts & Statements of Accounts – December 2019.
Attachment 2: Declaration.

A. BACKGROUND / DETAILS

The reporting of monthly financial information is a requirement under section 6.4 of the Local Government Act 1995, and Regulation 34 of the Local Government (Financial Management) Regulations.

Pursuant to Financial Management Regulation 13, a list of payments made from Municipal and Trust accounts is required to be presented to Council on a periodical basis. These details are included as Attachment 1. In accordance with Financial Management Regulation 12, the Chief Executive Officer has delegated authority to make these payments.

B. CONSIDERATIONS

B.1 Strategic Community / Corporate Business Plan

Theme Area 6: Governance & Leadership.

Outcome 6.3: The Shire of Northam council is a sustainable, responsive, innovative and transparent organisation.

B.2 Financial / Resource Implications

Payments of accounts are in accordance with Council's 2019/20 Budget.

B.3 Legislative Compliance

Section 6.4 & 6.26(2) (g) of the Local Government Act 1995.
Financial Management Regulations 2007, Regulation 12 & 13.

B.4 Policy Implications

Nil.

B.5 Stakeholder Engagement / Consultation

Not applicable.

B.6 Risk Implications

Risk Category	Description	Rating (consequence x likelihood)	Mitigation Action
Financial	Figures not reflecting the true financial situation	Low	There are processes in place to show compliance with relevant legislation
Health & Safety	N/A	N/A	N/A
Reputation	N/A	N/A	N/A
Service Interruption	N/A	N/A	N/A
Compliance	Report not being accepted by Council	Low	There are processes in place to show compliance with relevant legislation
Property	N/A	N/A	N/A
Environment	N/A	N/A	N/A

C. OFFICER'S COMMENT

The matter of Council 'supporting local business' has been raised over a long period. To assist in providing a greater understanding of the purchasing patterns of the Shire of Northam, the following graph summarises the payments made locally for the month of December 2019;

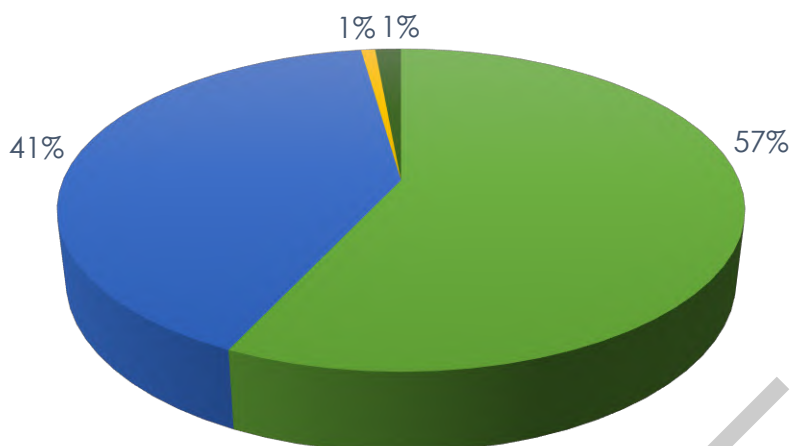

- Purchased from Shire of Northam Businesses or Individuals
- No Organisation or Business in Shire of Northam that can offer service required
- Purchase from Businesses or Individuals outside Shire of Northam
- Contract has gone to Tender

RECOMMENDATION / COUNCIL DECISION

Minute No: C.3863

Moved: Cr Mencshelyi

Seconded: Cr Galloway

That Council endorse the payments for the period 1 December 2019 to 31 December 2019, as listed, which have been made in accordance with the delegated authority reference number (M/F/F/Regs LGA 1995 S5.42).

CARRIED 10/0

Attachment 1

Date: 07/01/2020
Time: 8:12:43AM

Shire of Northam

USER: Kathy Scholz
PAGE: 1

Cheque /EFT No	Date	Name	Invoice Description	Bank Code	INV Amount	Amount
EFT34994	06/12/2019	DONALD VEAL CONSULTANTS PTY LTD	CONSULTANT SERVICES FOR NORTHAM BIKE PLAN 2019 DATED AUGUST2019 AS SET OUT IN TABLE 5.1 SEE ATTACHED	1		6,032.40
INV 1904000506/11/2019		DONALD VEAL CONSULTANTS PTY LTD	CONSULTANT SERVICES FOR NORTHAM BIKE PLAN 2019 DATED AUGUST2019 AS SET OUT IN TABLE 5.1 SEE ATTACHED	1	6,032.40	
EFT34995	06/12/2019	ABBOTTS FORGE	SUPPLY AND FIT 12 X BRACE BARS FOR HIGH FENCES MATERIALS AS PER QUOTE 0003759	1		3,350.00
INV 0000376711/10/2019		ABBOTTS FORGE	REMOVE STEEL STRIP FROM ROAD GRATE ON EAST STREET 3/4H	1	150.00	
INV 0000375901/11/2019		ABBOTTS FORGE	SUPPLY AND FIT 12 X BRACE BARS FOR HIGH FENCES MATERIALS AS PER QUOTE 0003759	1	3,200.00	
EFT34996	06/12/2019	ACCESS UNLIMITED INTERNATIONAL PTY LTD	SCBA TRAINING	1		1,900.00
INV 129620	29/10/2019	ACCESS UNLIMITED INTERNATIONAL PTY LTD	SCBA TRAINING	1	1,900.00	
EFT34997	06/12/2019	ADVANCED TRAFFIC MANAGEMENT (WA) PTY LTD	2019 AVON RIVER FESTIVAL - SIGNAGE & TRAFFIC CONTROLLERS	1		4,323.00
INV 0012876105/08/2019		ADVANCED TRAFFIC MANAGEMENT (WA) PTY LTD	2019 AVON RIVER FESTIVAL - SIGNAGE & TRAFFIC CONTROLLERS	1	4,323.00	
EFT34998	06/12/2019	AG IMPLEMENTS NORTHAM PTY LTD	1X SET OF 72 BLADES (SET OF 3)	1		1,388.39
INV 379360	28/10/2019	AG IMPLEMENTS NORTHAM PTY LTD	1X SET OF 72 BLADES (SET OF 3)	1	796.80	
INV 379647	29/10/2019	AG IMPLEMENTS NORTHAM PTY LTD	REMOVE AND REPLACE BELT AND BATTERY AND TEST START.	1	587.98	
INV 379897	30/10/2019	AG IMPLEMENTS NORTHAM PTY LTD	BUSH CONVERT B351	1	3.61	
EFT34999	06/12/2019	ALL-WAYS FOODS	STOCK PURCHASES FOR NORTHAM POOL.	1		624.02
INV 44989	12/11/2019	ALL-WAYS FOODS	STOCK PURCHASES FOR NORTHAM POOL.	1	624.02	
EFT35000	06/12/2019	ALLSTRONG OUTDOOR GARAGE DOORS	KILLARA COTTAGE, REPAIR ELECTRIC ROLLER DOOR, NOT OPERATING PROPERLY.	1		198.00

Ordinary Council Meeting Minutes
22 January 2020



Date: 07/01/2020
Time: 8:12:43AM

Shire of Northam

USER: Kathy Scholz
PAGE: 2

Cheque /EFT No	Date	Name	Invoice Description	Bank Code	INV Amount	Amount
INV 0000100821	11/2019	ALLSTRONG OUTDOOR GARAGE DOORS	KILLARA COTTAGE REPAIR ELECTRIC ROLLER DOOR, NOT OPERATING PROPERLY.	1	198.00	
EFT35001	06/12/2019	ANDY'S PLUMBING SERVICE	KURINGAL VILLAGE UNIT 2. PICK UP FROM BETTA ELECTRICAL AND INSTALL NEW GAS OVEN. DELIVER OLD UNIT TO THE NORTHAM DEPOT.	1		2,689.50
INV A18518	30/09/2019	ANDY'S PLUMBING SERVICE	KURINGAL VILLAGE UNIT 2. PICK UP FROM BETTA ELECTRICAL AND INSTALL NEW GAS OVEN. DELIVER OLD UNIT TO THE NORTHAM DEPOT.	1	1,199.00	
INV A18565	18/11/2019	ANDY'S PLUMBING SERVICE	REPAIRS TO KITCHEN SINK TAP IN COTTAGE	1	280.50	
INV A18562	18/11/2019	ANDY'S PLUMBING SERVICE	KURINGAL VILLAGE, UNIT 4. PLEASE REPAIR GAS LEAK TO BOTTLES.	1	374.00	
INV A18563	18/11/2019	ANDY'S PLUMBING SERVICE	KILLARA DAY RESPITE CARE. 6 MONTHLY GREASE TRAP EMPTYING AND REPORT TO WATER CORP	1	528.00	
INV A18564	18/11/2019	ANDY'S PLUMBING SERVICE	MEMORIAL HALL. INVESTIGATE PIPES THAT ARE MAKING NOISES IN FEMALES TOILETS.	1	308.00	
EFT35002	06/12/2019	APPLIED INDUSTRIAL TECHNOLOGIES T/A NORTHAM BEARINGS	YAR207-105-2F - BEARING	1		83.72
INV 6395888	22/10/2019	APPLIED INDUSTRIAL TECHNOLOGIES T/A NORTHAM BEARINGS	YAR207-105-2F - BEARING	1	81.18	
INV 0141788	22/10/2019	APPLIED INDUSTRIAL TECHNOLOGIES T/A NORTHAM BEARINGS	YAR207-105-2F - BEARING	1	-59.53	
INV 6395998	22/10/2019	APPLIED INDUSTRIAL TECHNOLOGIES T/A NORTHAM BEARINGS	YAR207-105-2F - BEARING	1	62.07	
EFT35003	06/12/2019	ASLAB PTY LTD	SPENCER BROOKE ROAD SLK 16.47 - 19.55 = 6 CORES SAMPLES, 11 PSD's & PT's	1		12,315.76
INV 0002264623	09/2019	ASLAB PTY LTD	SPENCER BROOK ROAD SLK 12.00-12.08 = 4 CORE SAMPLES, 7 PSD's & PT's	1	4,301.00	
INV 0002254623	09/2019	ASLAB PTY LTD	AS PER QUOTE 00022546 - PROFILE CORES, PSD's & PT's, WET GRADING, FIELD WORK, TRAVELLING.	1	1,260.76	
INV 0002256923	09/2019	ASLAB PTY LTD	SPENCER BROOKE ROAD SLK 16.47 - 19.55 = 6 CORES SAMPLES, 11 PSD's & PT's	1	6,754.00	
EFT35004	06/12/2019	ATTILA JOHN MENC SHELYI	COUNCILLOR PAYMENTS FOR NOVEMBER 2019	1		1,905.73
INV NOVEMEB0	11/2019	ATTILA JOHN MENC SHELYI	COUNCILLOR PAYMENTS FOR NOVEMBER 2019	1	1,905.73	

Ordinary Council Meeting Minutes
22 January 2020

Date: 07/01/2020
Time: 8:12:43AM

Shire of Northam

USER: Kathy Scholz
PAGE: 3

Cheque /EFT No	Date	Name	Invoice Description	Bank Code	INV Amount	Amount
EFT35005	06/12/2019	AUS RECORD	x 300 TUBE CLIP SETS	1		181.50
INV 0008985211/11/2019		AUS RECORD	x 300 TUBE CLIP SETS	1	181.50	
EFT35006	06/12/2019	AUSTRALIAN PAPER	x 3000 WINDOW FACED ENVELOPES 140034	1		119.46
INV 9621339824/10/2019		AUSTRALIAN PAPER	x 3000 WINDOW FACED ENVELOPES 140034	1	119.46	
EFT35007	06/12/2019	AUSTRALIAN SAFETY ENGINEERS	REFILL BREATHING APPARATUS AIR TANK.	1		16.50
INV 0146379W07/11/2019		AUSTRALIAN SAFETY ENGINEERS	REFILL BREATHING APPARATUS AIR TANK.	1	16.50	
EFT35008	06/12/2019	AUTOPRO NORTHAM	REPLACEMENT SISSOR JACK FOR REGO N9467 (PN1621)	1		32.37
INV 810212	28/10/2019	AUTOPRO NORTHAM	REPLACEMENT SISSOR JACK FOR REGO N9467 (PN1621)	1	32.37	
EFT35009	06/12/2019	AVON DEMOLITION & EARTHMOVING	MANAGEMENT OF INKPEN WASTE MANAGEMENT FACILITY 05/11/2019-178/11/2019	1		3,136.00
INV 0020	17/11/2019	AVON DEMOLITION & EARTHMOVING	MANAGEMENT OF INKPEN WASTE MANAGEMENT FACILITY 05/11/2019-178/11/2019	1	1,568.00	
INV 0021	01/12/2019	AVON DEMOLITION & EARTHMOVING	MANAGEMENT OF INKPEN WASTE MANAGEMENT FACILITY 19/11/2019 TO 01/12/2019.	1	1,568.00	
EFT35010	06/12/2019	AVON PAPER SHRED	EMPTYING OF SHREDDER BIN - ADMIN	1		65.00
INV 1516	12/11/2019	AVON PAPER SHRED	EMPTYING OF SHREDDER BIN - ADMIN	1	65.00	
EFT35011	06/12/2019	AVON VALLEY ARTS SOCIETY (INC)	STOCK PURCHASES FOR VISITORS CENTRE.	1		67.50
INV 48828	18/11/2019	AVON VALLEY ARTS SOCIETY (INC)	STOCK PURCHASES FOR VISITORS CENTRE.	1	67.50	
EFT35012	06/12/2019	AVON VALLEY CONTRACTORS	NORTHAM LIBRARY. SUPPLY EWP FOR BLOCKWORK REPAIRS.	1		478.00
INV 27716	20/11/2019	AVON VALLEY CONTRACTORS	PER CUBIC METRE OF VEGE MIX	1	128.00	
INV 27717	21/11/2019	AVON VALLEY CONTRACTORS	NORTHAM LIBRARY. SUPPLY EWP FOR BLOCKWORK REPAIRS.	1	350.00	
EFT35013	06/12/2019	AVON VALLEY ENVIRONMENTAL SOCIETY	GUIDED RIVER WALK (YERECOIN P.S VISIT TO BKB) 19/11/2019	1		150.00

Ordinary Council Meeting Minutes
22 January 2020



Date: 07/01/2020
Time: 8:12:43AM

Shire of Northam

USER: Kathy Scholz
PAGE: 4

Cheque /EFT No	Date	Name	Invoice Description	Bank Code	INV Amount	Amount
INV 9	19/11/2019	AVON VALLEY ENVIRONMENTAL SOCIETY	GUIDED RIVER WALK (YERECOMP.S VISIT TO BKB) 19/11/2019	1	150.00	
EFT35014	06/12/2019	AVON VALLEY GLASS	HOSPITALITY ROOM - REPLACE 4 X NEW STRAPS ON EXISTING ROLLER SHUTTER WILL REQUIRE TWO PEOPLE AS NEED TO PULL DOWN ROLLER SHUTTER	1		1,247.40
INV 0001031011/11/2019		AVON VALLEY GLASS	HOSPITALITY ROOM - REPLACE 4 X NEW STRAPS ON EXISTING ROLLER SHUTTER WILL REQUIRE TWO PEOPLE AS NEED TO PULL DOWN ROLLER SHUTTER	1	1,247.40	
EFT35015	06/12/2019	AVON VALLEY PLANT & EQUIPMENT PTY LTD	35 TONNE OF CRACKER DUST	1		649.41
INV IV10456	30/10/2019	AVON VALLEY PLANT & EQUIPMENT PTY LTD	35 TONNE OF CRACKER DUST	1	649.41	
EFT35016	06/12/2019	AVON WASTE	MANAGEMENT OF THE OLD QUARRY ROAD WASTE MANAGEMENT FACILITY NOVEMBER 2019	1		46,734.38
INV 0003642922/11/2019		AVON WASTE	MANAGEMENT OF THE OLD QUARRY ROAD WASTE MANAGEMENT FACILITY NOVEMBER 2019	1	46,734.38	
EFT35017	06/12/2019	BALLANTYNES JEWELLERS	LEAVING GIFT FOR JAIMIE JONES	1		119.00
INV 001-465104/11/2019		BALLANTYNES JEWELLERS	LEAVING GIFT FOR JAIMIE JONES	1	119.00	
EFT35019	06/12/2019	BOEKEMAN MACHINERY	INVESTIGATE AND REPAIR MACHINE.	1		183.07
INV 269409	25/07/2019	BOEKEMAN MACHINERY	CREDIT FOR REPLACEMENT FILTERS SUPPLIED BY JCB.	1	-130.43	
INV 274571	18/10/2019	BOEKEMAN MACHINERY	INVESTIGATE AND REPAIR MACHINE.	1	313.50	
EFT35020	06/12/2019	BOQ ASSET FINANCE & LEASING PTY LTD	LEASE FEE FOR PHOTOCOPIER FOR CO WORKING SPACE /COMMUNITY DEVELOPMENT TEAM	1		145.56
INV 85342	06/11/2019	BOQ ASSET FINANCE & LEASING PTY LTD	LEASE FEE FOR PHOTOCOPIER FOR CO WORKING SPACE /COMMUNITY DEVELOPMENT TEAM	1	145.56	
EFT35021	06/12/2019	BROOKLANDS SUPER PTY LTD	COUNCILLOR PAYMENTS FOR NOVEMBER 2019	1		1,100.00
INV NOVEMEB0/11/2019		BROOKLANDS SUPER PTY LTD	COUNCILLOR PAYMENTS FOR NOVEMBER 2019	1	1,100.00	
EFT35022	06/12/2019	BUNNINGS BUILDING SUPPLIES P/L	1.8M STEP LADDER	1		225.15

Ordinary Council Meeting Minutes
22 January 2020

Date: 07/01/2020
Time: 8:12:43AM

Shire of Northam

USER: Kathy Scholz
PAGE: 5

Cheque /EFT No	Date	Name	Invoice Description	Bank Code	INV Amount	Amount
INV 2180/01126/11/2019		BUNNINGS BUILDING SUPPLIES P/L	1.8M STEP LADDER	1	225.15	
EFT35023	06/12/2019	BURGESS RAWSON (WA) PTY LTD	WATER & SEWERAGE MONTHLY RATES FOR DUMP POINT ON PEEL TERRACE FOR 1/7/2019 TO 30/06/2020	1		58.87
INV 6358	15/11/2019	BURGESS RAWSON (WA) PTY LTD	WATER & SEWERAGE MONTHLY RATES FOR DUMP POINT ON PEEL TERRACE FOR 1/7/2019 TO 30/06/2020	1	58.87	
EFT35024	06/12/2019	BUSHLOLLY ENTERPRISES PTY LTD T/A BUSHLOLLY ABORIGINAL AUSTRALIAN NATIVE FOODS	BUSH FOODS & JAMS FOR STOCK AT BKB	1		449.25
INV INV-170518/11/2019		BUSHLOLLY ENTERPRISES PTY LTD T/A BUSHLOLLY ABORIGINAL AUSTRALIAN NATIVE FOODS	BUSH FOODS & JAMS FOR STOCK AT BKB	1	449.25	
EFT35025	06/12/2019	BUZZINROUND PTY LTD T/A BR. COMMS	PROGRAM HUNT GROUP IN PABX	1		121.00
INV 0000283720/11/2019		BUZZINROUND PTY LTD T/A BR. COMMS	PROGRAM HUNT GROUP IN PABX	1	121.00	
EFT35026	06/12/2019	CAMERON VAN DER DOES T/AS CAMERON THE MAGICIAN	MEERILINGA GRANT - MAGIC SHOW - CHILDREN'S WEEK AT NORTHAM LIBRARY	1		400.00
INV 2210201922/10/2019		CAMERON VAN DER DOES T/AS CAMERON THE MAGICIAN	MEERILINGA GRANT - MAGIC SHOW - CHILDREN'S WEEK AT NORTHAM LIBRARY	1	400.00	
EFT35027	06/12/2019	CANNON HYGIENE AUSTRALIA PTY LTD	VISITORS CENTRE. STEAM HYGIENE TREATMENT OF THE URINAL.	1		635.72
INV 9649860114/10/2019		CANNON HYGIENE AUSTRALIA PTY LTD	VISITORS CENTRE. MONTHLY SANITARY UNIT SERVICE 14/11/2019-13/05/2020	1	283.72	
INV 9652159214/11/2019		CANNON HYGIENE AUSTRALIA PTY LTD	VISITORS CENTRE. STEAM HYGIENE TREATMENT OF THE URINAL.	1	352.00	
EFT35028	06/12/2019	CARL PHILLIP DELLA	COUNCILLOR PAYMENTS FOR NOVEMBER 2019	1		1,905.73
INV NOVEMBER/11/2019		CARL PHILLIP DELLA	COUNCILLOR PAYMENTS FOR NOVEMBER 2019	1	1,905.73	
EFT35029	06/12/2019	CENTRAL MOBILE MECHANICAL REPAIRS	SUPPLY HIAB VALVE.	1		8,148.86
INV 0000295801/12/2019		CENTRAL MOBILE MECHANICAL REPAIRS	EMERGENCY REPAIRS (SAFETY ISSUES) TO TAILGATE ON PN0913 - REGO N3805	1	635.80	
INV 0000295901/12/2019		CENTRAL MOBILE MECHANICAL REPAIRS	SUPPLY HIAB VALVE.	1	1,681.90	

Ordinary Council Meeting Minutes
22 January 2020



Date: 07/01/2020
Time: 8:12:43AM

Shire of Northam

USER: Kathy Scholz
PAGE: 6

Cheque /EFT No	Date	Name	Invoice Description	Bank Code	INV Amount	Amount
INV 0000296001/12/2019		CENTRAL MOBILE MECHANICAL REPAIRS	120,000KM SERVICE ON PN0913 - REGO N3805	1	828.63	
INV 0000296401/12/2019		CENTRAL MOBILE MECHANICAL REPAIRS	3750HR SERVICE ON KOMATSU LOADER PN1003 - REGO N3856 REPORT AT TIME OF ANY ISSUES	1	1,216.16	
INV 0000295701/12/2019		CENTRAL MOBILE MECHANICAL REPAIRS	4850HOUR SERVICE TO TOYOTA FORKLIFT	1	510.46	
INV 0000296601/12/2019		CENTRAL MOBILE MECHANICAL REPAIRS	PN1405 INSPECT CLUTCH ISSUE/ CHECK FOR ANY GAS LEAKS REPORT ON ISSUES AT THE TIME	1	268.40	
INV 0000296301/12/2019		CENTRAL MOBILE MECHANICAL REPAIRS	FIT NEW WIPER MOTOR/NEW WIPER ARM/BLADES - FIND REPORTED OIL LEAK (APPEARS TO HAPPEN UNDER PRESSURE) REPORT ANY ISSUES PN0916 - REGO N006	1	132.00	
INV 0000296701/12/2019		CENTRAL MOBILE MECHANICAL REPAIRS	SERVICE PIG TAIL PN1009A ALSO REPLACE MISSING/BLOACKED GREESE NIPPLES (THIS WILL BE ATTACHED TO PN1515	1	440.00	
INV 0000296501/12/2019		CENTRAL MOBILE MECHANICAL REPAIRS	100,000KM SERVICE MITSUBISHI FUSCO TWO WAY TIP TRUCK PN1515 - REGO N11187 PLEASE REPORT ON ANY ISSUES AT THE TIME	1	1,367.52	
INV 0000296801/12/2019		CENTRAL MOBILE MECHANICAL REPAIRS	RADIATOR IS OVERHEATING WHEN FULLY LOADED/GOING UP HILLS. PLEASE INSPECT AND FIX IN PN1201 - REGO N.008 ALSO CHECK ISSUE WITH AIRCOND RETIFLY IF NEEDED TO STOP SUCKING AIR IN FROM OUTSIDE. REPORT/ PHOTOS	1	574.20	
INV 0000296201/12/2019		CENTRAL MOBILE MECHANICAL REPAIRS	REPAIRS TO STEEL DRUM ROLLER PN1006	1	295.79	
INV 0000296101/12/2019		CENTRAL MOBILE MECHANICAL REPAIRS	REMOVE RANGER POD FROM PN1514 TO STORE AT DEPO AS SPARE	1	198.00	
EFT35030	06/12/2019	CHRISTOPHER RICHARD ANTONIO	COUNCILLOR PAYMENTS NOVEMBER 2019	1		5,860.76
INV NOVEMB0/11/2019		CHRISTOPHER RICHARD ANTONIO	COUNCILLOR PAYMENTS NOVEMBER 2019	1	5,860.76	
EFT35031	06/12/2019	CLACKLINE FENCING CONTRACTORS	EMERGENCY REPAIRS TO SECURE SITE. FOR THE WEEKEND. SUPPLY AND INSTALL NEW GATES, STRAINER AND STRUT,	1		2,440.00
INV 1266	14/11/2019	CLACKLINE FENCING CONTRACTORS	EMERGENCY REPAIRS TO SECURE SITE. FOR THE WEEKEND. SUPPLY AND INSTALL NEW GATES, STRAINER AND STRUT,	1	2,440.00	

Ordinary Council Meeting Minutes
22 January 2020



Date: 07/01/2020
Time: 8:12:43AM

Shire of Northam

USER: Kathy Scholz
PAGE: 7

Cheque /EFT No	Date	Name	Invoice Description	Bank Code	INV Amount	Amount
EFT35032	06/12/2019	CLARK EQUIPMENT	WIPER MOTOR PART NUMBER 6679476 EX EAST FOR PN0916 - REGO N006	1		452.83
INV 0820087807/11/2019		CLARK EQUIPMENT	WIPER MOTOR PART NUMBER 6679476 EX EAST FOR PN0916 - REGO N006	1	452.83	
EFT35033	06/12/2019	CLEANAWAY DANIELS SERVICES PTY LTD	BAKERS HILL HOOPER PARK TOILETS. FORTNIGHTLY SHARP DISPOSAL SERVICE UNTIL DEC 2019.	1		989.61
INV 1802692	31/10/2019	CLEANAWAY DANIELS SERVICES PTY LTD	BAKERS HILL HOOPER PARK TOILETS. FORTNIGHTLY SHARP DISPOSAL SERVICE UNTIL DEC 2019.	1	188.50	
INV 1802689	31/10/2019	CLEANAWAY DANIELS SERVICES PTY LTD	BAKERS HILL HOOPER PARK TOILETS. FORTNIGHTLY SHARP DISPOSAL SERVICE UNTIL DEC 2019.	1	282.74	
INV 1802691	31/10/2019	CLEANAWAY DANIELS SERVICES PTY LTD	APEX PARK TOILETS. FORTNIGHTLY SHARP DISPOSAL SERVICE UNTIL DEC 2019.	1	235.62	
INV 1802690	31/10/2019	CLEANAWAY DANIELS SERVICES PTY LTD	BERNARD PARK TOILETS. MONTHLY SHARP DISPOSAL SERVICE UNTIL DEC 2019.	1	188.50	
INV 1802693	31/10/2019	CLEANAWAY DANIELS SERVICES PTY LTD		1	94.25	
EFT35034	06/12/2019	COCA-COLA AMATIL (AUST) PTY LTD	STOCK PURCHASES NORTHAM POOL.	1		453.20
INV 2213076413/11/2019		COCA-COLA AMATIL (AUST) PTY LTD	STOCK PURCHASES NORTHAM POOL.	1	453.20	
EFT35035	06/12/2019	COMBINED TYRES	SUPPLY AND FIT BF GOODRICH KO2'S 265/70R16 FOR PN1710 - REGO N79 PLEASE HAVE THE WHITE WRITING OF TYRE TO OUTSIDE	1		2,113.10
INV INV-329607/11/2019		COMBINED TYRES	BRIDGESTONE 235/85R16 TYRE REPLACE	1	441.10	
INV INV-332008/11/2019		COMBINED TYRES	SUPPLY AND FIT BF GOODRICH KO2'S 265/70R16 FOR PN1710 - REGO N79 PLEASE HAVE THE WHITE WRITING OF TYRE TO OUTSIDE	1	1,672.00	
EFT35036	06/12/2019	COUNTRY COMFORTSTYLE NORTHAM	FURNITURE FOR THE LIBRARY	1		1,725.00
INV 8346	02/10/2019	COUNTRY COMFORTSTYLE NORTHAM	FURNITURE FOR THE LIBRARY	1	1,725.00	
EFT35037	06/12/2019	COUNTRY COPIERS NORTHAM	COLOUR COPIER SERVICE/METER READING FOR ADMIN	1		4,591.69
INV S8022	05/11/2019	COUNTRY COPIERS NORTHAM	PRINTING CHARGES - SPREEDSHEET ATTACHED DEPO 01-08-2019 TO 04-11-2019	1	972.30	
INV S8023	05/11/2019	COUNTRY COPIERS NORTHAM	VC PRINTER READING NOVEMBER 2019	1	913.33	

Ordinary Council Meeting Minutes
22 January 2020



Date: 07/01/2020
Time: 8:12:43AM

Shire of Northam

USER: Kathy Scholz
PAGE: 8

Cheque /EFT No	Date	Name	Invoice Description	Bank Code	INV Amount	Amount
INV S8020	05/11/2019	COUNTRY COPIERS NORTHAM	COLOUR COPIER METER READINGS FROM 30/05/19 - 29/10/19 FOR KILLARA PHOTOCOPIER	1	842.60	
INV S8021	05/11/2019	COUNTRY COPIERS NORTHAM	Library photocopier service	1	550.69	
INV S8048	28/11/2019	COUNTRY COPIERS NORTHAM	COLOUR COPIER SERVICE/METER READING FOR ADMIN	1	1,312.77	
EFT35038	06/12/2019	COUNTRYWIDE GROUP	9605101-63 TC238 CATCHER RIDE ON MOWER	1		9,521.79
INV 28325	24/10/2019	COUNTRYWIDE GROUP	CHLORINE FOR POOLS	1	780.78	
INV 28389	04/11/2019	COUNTRYWIDE GROUP	KUBOTTA 24 1/2" X 3" X 72 PRO BLADE PN1005	1	187.00	
INV 28465	18/11/2019	COUNTRYWIDE GROUP	KUBOTTA 24 1/2" X 3" X 72 PRO BLADE PN1005	1	93.50	
INV 28463	18/11/2019	COUNTRYWIDE GROUP	15 LIQUID CHLORINE.	1	114.51	
INV 28466	18/11/2019	COUNTRYWIDE GROUP	HUSQVANA BRUSHCUTTER 525RS 9672108-01 WITH ALUMINIUM HEAD	1	690.93	
INV 28488	20/11/2019	COUNTRYWIDE GROUP	9605101-63 TC238 CATCHER RIDE ON MOWER	1	4,353.64	
INV 28499	21/11/2019	COUNTRYWIDE GROUP	1000HR SERVICE, FIXING STARTING ISSUE, RETICTIFIC AND REPAIR ISSUES AS DISCUSSEED, REPLACE WORN DECK WHEELS/ PN1005 - REGO N.3862	1	3,201.43	
INV 28502	22/11/2019	COUNTRYWIDE GROUP	EDGER BLADES PER PACK OF 10	1	100.00	
EFT35039	06/12/2019	CTI SECURITY SERVICES PTY LTD	SECURITY MONITORING RSL MEMORIAL HALL 01/11/2019-30/11/2019	1		850.25
INV CINS307415/10/2019		CTI SECURITY SERVICES PTY LTD	SECURITY MONITORING RSL MEMORIAL HALL 01/11/2019-30/11/2019	1	90.56	
INV CINS307415/10/2019		CTI SECURITY SERVICES PTY LTD	SECURITY MONITORING BERT HAWKE OVAL 01/11/2019-30/11/2019	1	53.00	
INV CINS307415/10/2019		CTI SECURITY SERVICES PTY LTD	SECURITY MONITORING SES BUILDING 01/11/2019-30/11/2019	1	87.96	
INV CINS307415/10/2019		CTI SECURITY SERVICES PTY LTD	SECURITY MONITORING NORTHAM REC CENTRE 01/11/2019-30/11/2019	1	61.97	
INV CINS307415/10/2019		CTI SECURITY SERVICES PTY LTD	SECURITY MONITORING 01/11/2019-30/11/2019	1	87.96	
INV CINS307415/10/2019		CTI SECURITY SERVICES PTY LTD	SECURITY MONITORING FOR BKB 01/11/2019-30/11/2019	1	61.96	
INV CINS307415/10/2019		CTI SECURITY SERVICES PTY LTD	SECURITY MONITORING FOR NORTHAM LIBRARY 01/11/2019-30/11/2019	1	61.96	

Ordinary Council Meeting Minutes
22 January 2020



Date: 07/01/2020
Time: 8:12:43AM

Shire of Northam

USER: Kathy Scholz
PAGE: 9

Cheque /EFT No	Date	Name	Invoice Description	Bank Code	INV Amount	Amount
INV CINS307415/10/2019		CTI SECURITY SERVICES PTY LTD	OLD GIRLS SCHOOL. SECURITY MONITORING FROM 01/11/2019 to 30/11/2019.	1	61.96	
INV CINS307415/10/2019		CTI SECURITY SERVICES PTY LTD	SECURITY MONITORING FOR OLD RAILWAY STATION 01/11/2019-30/11/2019	1	61.96	
INV CINS307415/10/2019		CTI SECURITY SERVICES PTY LTD	SECURITY MONITORING FOR WUNDOWIE LIBRARY 01/11/2019-30/11/2019	1	53.00	
INV CINS307415/10/2019		CTI SECURITY SERVICES PTY LTD	SECURITY MONITORING FOR VISITORS CENTRE 01/11/2019-30/11/2019	1	61.96	
INV CINS307415/10/2019		CTI SECURITY SERVICES PTY LTD	SECURITY MONITORING FOR NORTHAM SWIMMING POOL 01/11/2019-30/11/2019	1	53.00	
INV CINS307415/10/2019		CTI SECURITY SERVICES PTY LTD	SECURITY MONITORING MORBY COTTAGE 01/11/2019-30/11/2019	1	53.00	
EFT35040	06/12/2019	CTI SECURITY SYSTEMS PTY LTD T/AS SECURUS	SES SHED. REPLACE PANEL BATTERY FROM SERVICE.	1		110.00
INV 116730	24/10/2019	CTI SECURITY SYSTEMS PTY LTD T/AS SECURUS	SES SHED. REPLACE PANEL BATTERY FROM SERVICE.	1	55.00	
INV 116729	24/10/2019	CTI SECURITY SYSTEMS PTY LTD T/AS SECURUS	SES BUILDING. REPLACE PANEL BATTERY FROM SERVICE.	1	55.00	
EFT35041	06/12/2019	CUTTING EDGES EQUIPMENT PARTS	GB6658HT GRADER BLADE HT CURV (RED) 1828 X 16 X 13H (5/8")	1		2,326.73
INV 3264918	08/11/2019	CUTTING EDGES EQUIPMENT PARTS		1	2,163.69	
INV 3265460	13/11/2019	CUTTING EDGES EQUIPMENT PARTS	2D5572 KNOCK ON RIPPER BOOTS FOR GRADERS	1	163.04	
EFT35042	06/12/2019	DAMIAN'S PLUMBING	INSTALLATION OF EYEWASH, CONCRETE PAD AND SHOWER - BURY COPPER PIPE.	1		1,375.00
INV 4610	18/11/2019	DAMIAN'S PLUMBING	INSTALLATION OF EYEWASH, CONCRETE PAD AND SHOWER - BURY COPPER PIPE.	1	1,375.00	
EFT35043	06/12/2019	DAVID HOWARD GOLDSMITH	RATES CREDIT REFUND FOR ASSESSMENT A10103	1		400.00
INV A.10103	06/12/2019	DAVID HOWARD GOLDSMITH	RATES CREDIT REFUND FOR ASSESSMENT A10103		400.00	
EFT35044	06/12/2019	DAVID JAMES GALLOWAY	COUNCIL PAYMENTS FOR MONTH OF NOVEMBER 2019	1		2,268.33
INV NOVEMBER0/11/2019		DAVID JAMES GALLOWAY	COUNCIL PAYMENTS FOR MONTH OF NOVEMBER 2019	1	2,268.33	

Ordinary Council Meeting Minutes
22 January 2020



Date: 07/01/2020
Time: 8:12:43AM

Shire of Northam

USER: Kathy Scholz
PAGE: 10

Cheque /EFT No	Date	Name	Invoice Description	Bank Code	INV Amount	Amount
EFT35045	06/12/2019	DEBBIE HUGHES - PERTH FACE PAINTING COMPANY	MEERILINGA GRANT - FACEPAINTER 1.5HRS	1		165.00
INV 3126	03/11/2019	DEBBIE HUGHES - PERTH FACE PAINTING COMPANY	MEERILINGA GRANT - FACEPAINTER 1.5HRS	1	165.00	
EFT35046	06/12/2019	DEPARTMENT OF LOCAL GOVERNMENT, SPORT AND CULTURAL INDUSTRIES	50% ELECTRICITY CHARGES-298 FITZGERALD ST FOR NOVEMBER.	1		134.08
INV RI02483214/11/2019	06/12/2019	DEPARTMENT OF LOCAL GOVERNMENT, SPORT AND CULTURAL INDUSTRIES	50% ELECTRICITY CHARGES-298 FITZGERALD ST FOR NOVEMBER.	1	134.08	
EFT35047	06/12/2019	DEPENDABLE LAUNDRY SOLUTIONS	FOLLOWING INSPECTION OF WASHING MACHINE TECHNICIAN FOUND AIR TRAP FAULTY AND REQUIRED REPLACEMENT. FAULTY AIR TRAP REMOVED AND REPLACED. CALLOUT FEE & LABOUR	1		297.00
INV DI20190315/10/2019	06/12/2019	DEPENDABLE LAUNDRY SOLUTIONS	FOLLOWING INSPECTION OF WASHING MACHINE TECHNICIAN FOUND AIR TRAP FAULTY AND REQUIRED REPLACEMENT. FAULTY AIR TRAP REMOVED AND REPLACED. CALLOUT FEE & LABOUR	1	297.00	
EFT35048	06/12/2019	DROMEDAIRY AUSTRALIA	STOCK PURCHASES FOR VISITORS CENTRE.	1		113.60
INV 2369	12/11/2019	DROMEDAIRY AUSTRALIA	STOCK PURCHASES FOR VISITORS CENTRE.	1	113.60	
EFT35049	06/12/2019	EFIRE & SAFETY	NORTHAM REC CENTRE. FIRE DETECTION SYSTEM MONTHLY SERVICING FROM 01ST JULY 2019 TILL 30/06/2020.	1		399.30
INV 511172	31/10/2019	EFIRE & SAFETY	TOWN HALL. FIRE DETECTION SYSTEM MONTHLY SERVICING. FROM 01 JUL 2019 TILL 30/06/2020.	1	162.80	
INV 511162	04/11/2019	EFIRE & SAFETY	NORTHAM REC CENTRE. FIRE DETECTION SYSTEM MONTHLY SERVICING FROM 01ST JULY 2019 TILL 30/06/2020.	1	236.50	
EFT35050	06/12/2019	ELDERS LIMITED	20L GLY SOPHATE PER DRUM	1		480.00
INV AX5074511/11/2019	06/12/2019	ELDERS LIMITED	20L GLY SOPHATE PER DRUM	1	480.00	
EFT35052	06/12/2019	FRANK DAVIS	SENIORS DAY BKB ACTIVITY INC WELCOME TO COUNTRY	1		1,100.00

Ordinary Council Meeting Minutes
22 January 2020



Date: 07/01/2020
Time: 8:12:43AM

Shire of Northam

USER: Kathy Scholz
PAGE: 11

Cheque /EFT No	Date	Name	Invoice Description	Bank Code	INV Amount	Amount
INV 8	21/10/2019	FRANK DAVIS	FRANK DAVIS - WELCOME TO COUNTRY (FORM FAMILY DAY 21/10/2019)	1	300.00	
INV 9	14/11/2019	FRANK DAVIS	DIDGERIDOO PLAYING & STORY TELLING (YEREGGIN P.S VISIT TO BKB) 19-11-2019	1	300.00	
INV 10	14/11/2019	FRANK DAVIS	SENIORS DAY BKB ACTIVITY INC WELCOME TO COUNTRY	1	500.00	
EFT35053	06/12/2019	FRESH START RECOVERY PROGRAMME	CATERING FOR SENIORS WEEK AT BKB	1		396.00
INV 0029173512	11/2019	FRESH START RECOVERY PROGRAMME	CATERING FOR SENIORS WEEK AT BKB	1	396.00	
EFT35054	06/12/2019	GARRY RAYMOND HOST	PRIZE DONATED BY TOODYAY COMMUNITY BANK (BENDIGO) FOR EARLY RATES INCENTIVE A12357	1		500.00
INV CY2811208	11/2019	GARRY RAYMOND HOST	PRIZE DONATED BY TOODYAY COMMUNITY BANK (BENDIGO) FOR EARLY RATES INCENTIVE A12357	1	500.00	
EFT35055	06/12/2019	GDR CIVIL CONTRACTING PTY LTD	P/U Drum Roller from Spencers Brook Rd and Deliver to Beering Rd where the bitumen ends and the gravel begins on Friday 01/11/2019	1		2,475.00
INV 001557	10/09/2019	GDR CIVIL CONTRACTING PTY LTD	COLLECT MULTITIRE ROLLER FROM INTERSECTION OF THROSSEL & CRORKAN RD NORTHAM AND DELIVER TO JUBILEE SHOWGROUNDS.	1	495.00	
INV 001558	13/09/2019	GDR CIVIL CONTRACTING PTY LTD	COLLECT MULTITIRE ROLLER FORM SHOWGROUNDS AND DELIVER TO INTERSECTION OF THROSSELL ST & BURN ST NORTHAM.	1	660.00	
INV 001580	03/11/2019	GDR CIVIL CONTRACTING PTY LTD	P/U Drum Roller from Spencers Brook Rd and Deliver to Beering Rd where the bitumen ends and the gravel begins on Friday 01/11/2019	1	1,320.00	
EFT35056	06/12/2019	GLENN STUART BEVERIDGE	ASBESTOS CLEAN UP AT A15663 AND A15662 - 65 AND 65A KINGIA ROAD, WUNDOWIE COPY OF REPORT TO BE PROVIDED AS PER STANDARD REQUIREMENTS.	1		1,848.00
INV 30	05/11/2019	GLENN STUART BEVERIDGE	REPLACE MISSING TILES ON NORTHAM POOL	1	770.00	
INV 32	05/11/2019	GLENN STUART BEVERIDGE	REPAIR TO SMALL DRILL HOLES IN WALL AND REPAINT SECTION OF WALL AT NORTHAM REC CENTRE	1	198.00	

Ordinary Council Meeting Minutes
22 January 2020

Date: 07/01/2020
Time: 8:12:43AM

Shire of Northam

USER: Kathy Scholz
PAGE: 12

Cheque /EFT No	Date	Name	Invoice Description	Bank Code	INV Amount	Amount
INV 31	05/11/2019	GLENN STUART BEVERIDGE	ASBESTOS CLEAN UP AT A15663 AND A15662 - 65 AND 65A KINGIA ROAD, WUNDOWIE COPY OF REPORT TO BE PROVIDED AS PER STANDARD REQUIREMENTS.	1	880.00	
EFT35057	06/12/2019	GOOLARRI MEDIA ENTERPRISES PTY LTD	ORAL HISTORY AND PLACE PUBLIC LECTURE - DR. ELAINE RABBITT, 12TH NOVEMBER 2019	1		550.00
INV G104638	07/11/2019	GOOLARRI MEDIA ENTERPRISES PTY LTD	ORAL HISTORY AND PLACE PUBLIC LECTURE - DR. ELAINE RABBITT, 12TH NOVEMBER 2019	1	550.00	
EFT35058	06/12/2019	GRAFTON ELECTRICS	CONNECT AND DISCONNECT POWER TO DEPOT DURING POWER OUTAGE TUESDAY 22/10/2019.	1		1,020.10
INV 6385	29/10/2019	GRAFTON ELECTRICS	CONNECT AND DISCONNECT POWER TO DEPOT DURING POWER OUTAGE TUESDAY 22/10/2019.	1	429.00	
INV 6401	29/10/2019	GRAFTON ELECTRICS	SES BUILDING. SAFETY CHECK ON ELECTRICS AND CHECK/REPAIR LIGHT SWITCH TO MANAGERS OFFICE.	1	133.10	
INV 6415	06/11/2019	GRAFTON ELECTRICS	NORTHAM DEPOT. EMERGENCY REPLACEMENT OF FAULTY FUSES IN MAIN ELECTRICITY POLE.	1	242.33	
INV 6429	14/11/2019	GRAFTON ELECTRICS	VISITORS CENTRE. REPORT ON LIGHT SWITCHING AND LABEL LIGHT SWITCHES. REPORT ON WHERE CENTRE CORRIDOOR LIGHTS ARE ACTIVATED.	1	215.67	
EFT35059	06/12/2019	GRASS VALLEY BUSH FIRE BRIGADE	FIRE MITIGATION WORKS AT GRASS VALLEY BMX SITE	1		200.00
INV 2019111313	11/2019	GRASS VALLEY BUSH FIRE BRIGADE	FIRE MITIGATION WORKS AT GRASS VALLEY BMX SITE	1	200.00	
EFT35060	06/12/2019	GROVE WESLEY DESIGN ART	COUNCIL NAME BADGES: CR MICHAEL RYAN, CR JULIE WILLIAMS, CR MARIA GIRAK, CR DAVID GALLOWAY	1		545.60
INV 5788	18/11/2019	GROVE WESLEY DESIGN ART	COUNCIL NAME BADGES: CR MICHAEL RYAN, CR JULIE WILLIAMS, CR MARIA GIRAK, CR DAVID GALLOWAY	1	441.10	
INV 5803	25/11/2019	GROVE WESLEY DESIGN ART	1 BOX BUSINESS CARDS - CR GALLOWAY	1	104.50	
EFT35061	06/12/2019	HEARTLANDS VETERINARY HOSPITAL - YORK	TREATMENT FOR INJURED, IMPOUNDED DOG	1		200.00
INV 975170	18/11/2019	HEARTLANDS VETERINARY HOSPITAL - YORK	TREATMENT FOR INJURED, IMPOUNDED DOG	1	200.00	

Ordinary Council Meeting Minutes
22 January 2020



Date: 07/01/2020
Time: 8:12:43AM

Shire of Northam

USER: Kathy Scholz
PAGE: 13

Cheque /EFT No	Date	Name	Invoice Description	Bank Code	INV Amount	Amount
EFT35062	06/12/2019	HEMA MAPS PTY LTD	STOCK PURCHASES FOR VISITORS CENTRE.	1		95.79
INV INV-356726/11/2019		HEMA MAPS PTY LTD	STOCK PURCHASES FOR VISITORS CENTRE.	1	95.79	
EFT35063	06/12/2019	ISOBEL ROBERTS T/AS CHICKEN LEGS	STOCK PURCHASES FOR VISITORS CENTRE.	1		30.00
INV 39	02/12/2019	ISOBEL ROBERTS T/AS CHICKEN LEGS	STOCK PURCHASES FOR VISITORS CENTRE.	1	30.00	
EFT35064	06/12/2019	IKOM OPERATIONS PTY LTD	920KG DRUM OF LIQUIFIED CHLORINE GAS	1		6,609.21
INV 6169285	23/10/2019	IKOM OPERATIONS PTY LTD	920KG DRUM OF LIQUIFIED CHLORINE GAS	1	3,116.30	
INV 6173105	31/10/2019	IKOM OPERATIONS PTY LTD	CHLORINE MONTHLY SERVICE FEE FOR TREATED WASTE WATER RETICULATION FOR THE PERIOD 01/07/2019 TO 30/06/2020 X 2 BOTTLES	1	376.61	
INV 6180906	20/11/2019	IKOM OPERATIONS PTY LTD	920KG CHLORINE GAS FRO NORTHAM WASTE WATER TREATMENT PLANT.	1	3,116.30	
EFT35065	06/12/2019	JAMES PAYNTER	RATES CREDIT REFUND FOR ASSESSMENT A1840	1		514.00
INV A1840	06/12/2019	JAMES PAYNTER	RATES CREDIT REFUND FOR ASSESSMENT A1840		514.00	
EFT35066	06/12/2019	JH COMPUTER SERVICES PTY LTD	UBIQUITI EDGEROUTER POE 5 PORT GIGABIT SWITCH ROUTER	1		264.00
INV 0000192422/11/2019		JH COMPUTER SERVICES PTY LTD	UBIQUITI EDGEROUTER POE 5 PORT GIGABIT SWITCH ROUTER	1	264.00	
EFT35067	06/12/2019	JOHN KELLY	CULTURAL DANCE SESSION (GREENMOUNT PRIMARY SCHOOL)	1		300.00
INV 2	15/11/2019	JOHN KELLY	CULTURAL DANCE SESSION (GREENMOUNT PRIMARY SCHOOL)	1	300.00	
EFT35068	06/12/2019	JR & A HERSEY PTY LTD	TOOLS FOR DEPOT.	1		368.79
INV 44743	26/11/2019	JR & A HERSEY PTY LTD	TOOLS FOR DEPOT.	1	368.79	
EFT35069	06/12/2019	JS TECHNOLOGY & DIGITAL PTY LTD	PHONE COVER & SCREEN PROTECTOR.	1		40.00
INV 6331	19/11/2019	JS TECHNOLOGY & DIGITAL PTY LTD	PHONE COVER & SCREEN PROTECTOR.	1	40.00	
EFT35070	06/12/2019	JULIE ELLEN GREENFIELD WILLIAMS	COUNCILLOR PAYMENTS NOVEMBER 2019	1		2,843.23

Date: 07/01/2020
Time: 8:12:43AM

Shire of Northam

USER: Kathy Scholz
PAGE: 14

Cheque /EFT No	Date	Name	Invoice Description	Bank Code	INV Amount	Amount
INV NOVEME30/11/2019		JULIE ELLEN GREENFIELD WILLIAMS	COUNCILLOR PAYMENTS NOVEMBER 2019	1	2,843.23	
EFT35071	06/12/2019	KLEENWEST DISTRIBUTORS	CHEMICALS, CONTAINERS, TOILET ROLLS, TISSUES & HAND TOWELS FOR KILLARA	1		271.21
INV 0004182806/11/2019		KLEENWEST DISTRIBUTORS	CHEMICALS, CONTAINERS, TOILET ROLLS, TISSUES & HAND TOWELS FOR KILLARA	1	271.21	
EFT35072	06/12/2019	KOMATSU AUSTRALIA PTY LTD	AF-NAC 20LT COOLANT FOR KOMATSU PC45 (PN1703 -REGO N.4346)	1		123.20
INV 0016642921/11/2019		KOMATSU AUSTRALIA PTY LTD	AF-NAC 20LT COOLANT FOR KOMATSU PC45 (PN1703 -REGO N.4346)	1	123.20	
EFT35073	06/12/2019	LANDMARK	20L GLADIATOR HERBICIDE	1		967.21
INV 9022333002/10/2019		LANDMARK	20L GLADIATOR HERBICIDE	1	525.80	
INV 9022761417/10/2019		LANDMARK	GAS REFILL	1	66.39	
INV 9022983124/10/2019		LANDMARK	ADMIN BUILDING. SUPPLY AND DELIVER 1 X GAS BOTTLE. PLUS DELIVERY COST	1	375.02	
EFT35074	06/12/2019	LEE ELLEN MAREE EDMONDS	PARKING FOR TRAINING COURSE	1		17.00
INV 04957	19/11/2019	LEE ELLEN MAREE EDMONDS	PARKING FOR TRAINING COURSE	1	17.00	
EFT35075	06/12/2019	LGC TRAFFIC MANAGEMENT	TRAFFIC MANAGERMENT (2 X TRAFFIC CONTROLLERS FOR CORE TESTING BY ASLAB ON MARTIN	1		1,126.13
INV WS-141731/10/2019		LGC TRAFFIC MANAGEMENT	TRAFFIC MANAGERMENT (2 X TRAFFIC CONTROLLERS FOR CORE TESTING BY ASLAB ON MARTIN	1	1,126.13	
EFT35076	06/12/2019	LGIS - LOCAL GOVERNMENT INSURANCE SERVICES	MOTOR VEHICLE PREMIUM 30/06/2019-30/06/2019	1		3,008.90
INV 062-2064305/11/2019		LGIS - LOCAL GOVERNMENT INSURANCE SERVICES	MOTOR VEHICLE PREMIUM 30/06/2019-30/06/2019	1	3,008.90	
EFT35078	06/12/2019	LGIS WA	PROPERTY INSURANCE 30/06/2018-30/06/2019	1		7,207.43
INV 100-136661/10/2019		LGIS WA	PROPERTY INSURANCE 30/06/2018-30/06/2019	1	7,207.43	
EFT35079	06/12/2019	LLOYDS EARTHMOVING	SYZGIUM BNUSH CHERRY 5LT	1		495.00
INV INV-153605/11/2019		LLOYDS EARTHMOVING	SYZGIUM BNUSH CHERRY 5LT	1	495.00	

Ordinary Council Meeting Minutes
22 January 2020



Date: 07/01/2020
Time: 8:12:43AM

Shire of Northam

USER: Kathy Scholz
PAGE: 15

Cheque /EFT No	Date	Name	Invoice Description	Bank Code	INV Amount	Amount
EFT35080	06/12/2019	LUME BRASSERIE	CATERING FOR INFLUENCERS EVENT	1		600.00
INV 2509201925/09/2019		LUME BRASSERIE	CATERING FOR INFLUENCERS EVENT	1	600.00	
EFT35082	06/12/2019	MADDISON LOBB	REIMBURSEMENT FOR LIFE GUARD TRAINING	1		299.00
INV WEB-12901/09/2019		MADDISON LOBB	REIMBURSEMENT FOR LIFE GUARD TRAINING	1	299.00	
EFT35083	06/12/2019	MAJOR MOTORS	PART - FUEL SENDER	1		177.35
INV 823977	14/10/2019	MAJOR MOTORS	PART - FUEL SENDER	1	177.35	
EFT35084	06/12/2019	MARIA IRENE GIRAK	COUNCILLOR PAYMENTS FOR THE NOVEMBER 2019	1		1,905.73
INV NOVEMBER 30/11/2019		MARIA IRENE GIRAK	COUNCILLOR PAYMENTS FOR THE NOVEMBER 2019	1	1,905.73	
EFT35085	06/12/2019	MARKETFORCE	DUTY POOL MANAGER IN THE AVON VALLEY ADVOCATE ON 2 OCTOBER 2019, SEEK AND LGASSIST	1		4,318.56
INV 30391	29/10/2019	MARKETFORCE	DUTY POOL MANAGER IN THE AVON VALLEY ADVOCATE ON 2 OCTOBER 2019, SEEK AND LGASSIST	1	1,213.27	
INV 30396	29/10/2019	MARKETFORCE	PUBLIC NOTICE FOR THE ADOPTION OF LPP NO. 25 - SCA	1	288.13	
INV 30389	29/10/2019	MARKETFORCE	EMPLOYMENT ADVERT IN THE AVON VALLEY ADVOCATE 04/09/2019 FOR SAFETY OFFICER	1	225.50	
INV 30397	29/10/2019	MARKETFORCE	NOTICE IN THE AVON VALLEY ADVOCATE FOR THE TEMPORARY CLOSURE OF GORDON PLACE - 30/10/2019	1	311.83	
INV 30395	29/10/2019	MARKETFORCE	PUBLIC NOTICE IN THE AVON VALLEY ADVOCATE ON 23/10/2019 FOR THE CHANGE OF MEETING LOCATION - NOVEMBER 2019 FORUM AND ORDINARY COUNCIL MEETING	1	240.75	
INV 30392	29/10/2019	MARKETFORCE	GENERAL LABOURER - ROAD/CIVIL CONSTRUCTION IN THE AVON VALLEY ADVOCATE ON 9 OCTOBER 2019 AND SEEK	1	857.62	
INV 30390	29/10/2019	MARKETFORCE	LOCAL GOVERNMENT ORDINARY POSTAL ELECTION NOTICE IN THE AVON VALLEY ADVOCATE ON 2 OCTOBER 2019	1	676.27	
INV 30393	29/10/2019	MARKETFORCE	ADVERT IN THE AVON VALLEY ADVOCATE ON 16/10/2019 FOR DISPOSAL OF PORTION HANGAR 19	1	264.44	

Ordinary Council Meeting Minutes
22 January 2020



Date: 07/01/2020
Time: 8:12:43AM

Shire of Northam

USER: Kathy Scholz
PAGE: 16

Cheque /EFT No	Date	Name	Invoice Description	Bank Code	INV Amount	Amount
INV 30394	29/10/2019	MARKETFORCE	ADVERT IN THE AVON VALLEY ADVOCATE ON 16/10/2019 FOR SPECIAL COUNCIL MEETING ON 21/10/2019	1	240.75	
EFT35086	06/12/2019	MAYDAY EARTHMOVING	DRY HIRE OF WATER TRUCK	1		5,390.00
INV 0007332811	10/2019	MAYDAY EARTHMOVING	DRY HIRE OF WATER TRUCK	1	5,390.00	
EFT35087	06/12/2019	MEGA-FIX	1/2" DRIVE SOCKET SET	1		853.60
INV 78960	08/11/2019	MEGA-FIX	1/2" DRIVE SOCKET SET	1	853.60	
EFT35088	06/12/2019	MICHAEL PATRICK RYAN	COUNCILLOR PAYMENTS FOR NOVEMBER 2019	1		1,905.73
INV NOVEMBER0	11/2019	MICHAEL PATRICK RYAN	COUNCILLOR PAYMENTS FOR NOVEMBER 2019	1	1,905.73	
EFT35089	06/12/2019	MIDALLIA STEEL	EXTRA FITTINGS / CHAINMESH REQUIRED TO AMEND CHANGES - THESE WERE MISSED AT THE TIME	1		666.69
INV 6246294	28/08/2019	MIDALLIA STEEL	EXTRA FITTINGS / CHAINMESH REQUIRED TO AMEND CHANGES - THESE WERE MISSED AT THE TIME	1	666.69	
EFT35090	06/12/2019	MINT CIVIL PTY LTD T/AS IMMACU SWEEP	STREET SWEEPING/GULLY EDUCATION SERVICES (CLEANING TOWN ROADS) FROM 11/11/2019 TO 17/11/2019.	1		7,524.00
INV N2368	18/11/2019	MINT CIVIL PTY LTD T/AS IMMACU SWEEP	STREET SWEEPING/GULLY EDUCATION SERVICES (CLEANING TOWN ROADS) FROM 11/11/2019 TO 17/11/2019.	1	3,762.00	
INV N2367	18/11/2019	MINT CIVIL PTY LTD T/AS IMMACU SWEEP	STREET SWEEPING/GULLY EDUCATION SERVICES (CLEANING TOWN ROADS) FROM 04/11/2019 TO 10/11/2019.	1	3,762.00	
EFT35091	06/12/2019	MM ELECTRICAL MERCHANDISING	DUAL MONITOR ARMS	1		76.95
INV 164947-602	12/2019	MM ELECTRICAL MERCHANDISING	DUAL MONITOR ARMS	1	76.95	
EFT35092	06/12/2019	MODERN TEACHING AIDS PTY LTD	WUNDOWIE LIBRARY - CHILDREN'S ROOM DIVIDER WITH STORAGE	1		919.59
INV 4380295425	10/2019	MODERN TEACHING AIDS PTY LTD	WUNDOWIE LIBRARY - CHILDREN'S ROOM DIVIDER WITH STORAGE	1	919.59	

Ordinary Council Meeting Minutes
22 January 2020



Date: 07/01/2020
Time: 8:12:43AM

Shire of Northam

USER: Kathy Scholz
PAGE: 17

Cheque /EFT No	Date	Name	Invoice Description	Bank Code	INV Amount	Amount
EFT35093	06/12/2019	MONIQUE HILL	OVER CHARGED FOR ROOM HIRE BOOKING #4116.	1		45.00
INV #4116	30/10/2019	MONIQUE HILL	OVER CHARGED FOR ROOM HIRE BOOKING #4116.	1	45.00	
EFT35094	06/12/2019	MOORE STEPHENS (WA) PTY LTD	ROADS TO RECOVERY AUDIT 18/19 ANNUAL RETURN TO 30 JUNE 2019	1		2,200.00
INV 314459	31/10/2019	MOORE STEPHENS (WA) PTY LTD	ROADS TO RECOVERY AUDIT 18/19 ANNUAL RETURN TO 30 JUNE 2019	1	2,200.00	
EFT35095	06/12/2019	MORRIS PEST AND WEED CONTROL	INSPECTION.	1		805.00
INV INV-017131/10/2019		MORRIS PEST AND WEED CONTROL	INSPECTION.	1	625.00	
INV INV-017231/10/2019		MORRIS PEST AND WEED CONTROL	ADMIN BUILDING. TREAT INSIDE OF BUILDING FOR MOSQUITOS AND BUGS.	1	180.00	
EFT35096	06/12/2019	NAVIGATOR PHOTOGRAFIX	PURCHASE OF 10 IMAGES OF SHIRE OF NORTHAM LANDSCAPES WITH LOGO REMOVED.	1		850.00
			SELECETED PHOTOS AS PER PROOFING DOCUMENT: ROW 1, PHOTOS 1 AND 2 (FROM THE LEFT) ROW 2, PHOTO 2 (FROM THE LEFT) ROW 3, PHOTOS 2 AND 6 (FROM THE LEFT) ROW 4, PHOTO 1 (FROM THE LEFT) ROW 5, PHOTOS 1 AND 4 (FROM THE LEFT) ROW 6, PHOTOS 5 AND 6 (FROM THE LEFT)			
INV 1014	02/12/2019	NAVIGATOR PHOTOGRAFIX	PURCHASE OF 10 IMAGES OF SHIRE OF NORTHAM LANDSCAPES WITH LOGO REMOVED.	1	850.00	
			SELECETED PHOTOS AS PER PROOFING DOCUMENT: ROW 1, PHOTOS 1 AND 2 (FROM THE LEFT) ROW 2, PHOTO 2 (FROM THE LEFT) ROW 3, PHOTOS 2 AND 6 (FROM THE LEFT) ROW 4, PHOTO 1 (FROM THE LEFT) ROW 5, PHOTOS 1 AND 4 (FROM THE LEFT) ROW 6, PHOTOS 5 AND 6 (FROM THE LEFT)			
EFT35097	06/12/2019	NAVMAN WIRELESS PTY LTD	SUBSCRIPTION SERVICE FEE FOR TWO MONTHS	1		835.34
INV 9173082805/09/2019		NAVMAN WIRELESS PTY LTD	SUBSCRIPTION SERVICE FEE FOR TWO MONTHS	1	417.67	

Ordinary Council Meeting Minutes
22 January 2020

Date: 07/01/2020
Time: 8:12:43AM

Shire of Northam

USER: Kathy Scholz
PAGE: 18

Cheque /EFT No	Date	Name	Invoice Description	Bank Code	INV Amount	Amount
INV 9181016805/11/2019		NAVMAN WIRELESS PTY LTD	SUBSCRIPTION SERVICE FEE FOR TWO MONTHS	1	417.67	
EFT35098	06/12/2019	NORTHAM BETTA ELECTRICAL	SUNBEAM MULTI PROCESSOR PLUS FOOD PROCESSOR AND BLENDER	1		845.90
INV 2001000515/10/2019		NORTHAM BETTA ELECTRICAL	SUNBEAM MULTI PROCESSOR PLUS FOOD PROCESSOR AND BLENDER	1	426.90	
INV 2001000614/11/2019		NORTHAM BETTA ELECTRICAL	LOGITECH KEYBAORD TO SUIT IPAD IPAD PRO GEN1	1	260.00	
INV 2001000614/11/2019		NORTHAM BETTA ELECTRICAL	A1652 ML212 X/A	1		
INV 2001000728/11/2019		NORTHAM BETTA ELECTRICAL	PHONE4 CHARGE CABLE	1	30.00	
			OLLEE 10HR25 TABLET	1	129.00	
EFT35099	06/12/2019	NORTHAM FEED & HIRE	DOG & CAT FOOD & OTHER MISCELLANEOUS ITEMS	1		169.00
INV 0000246708/11/2019		NORTHAM FEED & HIRE	DOG & CAT FOOD & OTHER MISCELLANEOUS ITEMS	1	37.00	
INV 0000246811/11/2019		NORTHAM FEED & HIRE	DOG & CAT FOOD & OTHER MISCELLANEOUS ITEMS	1	16.50	
INV 0000246912/11/2019		NORTHAM FEED & HIRE	DOG & CAT FOOD & OTHER MISCELLANEOUS ITEMS	1	16.50	
INV 0000247014/11/2019		NORTHAM FEED & HIRE	DOG & CAT FOOD & OTHER MISCELLANEOUS ITEMS	1	16.50	
INV 0000247915/11/2019		NORTHAM FEED & HIRE	DOG & CAT FOOD & OTHER MISCELLANEOUS ITEMS	1	16.50	
INV 0000248019/11/2019		NORTHAM FEED & HIRE	DOG & CAT FOOD & OTHER MISCELLANEOUS ITEMS	1	16.50	
INV 0000248520/11/2019		NORTHAM FEED & HIRE	DOG & CAT FOOD & OTHER MISCELLANEOUS ITEMS	1	16.50	
INV 0000249322/11/2019		NORTHAM FEED & HIRE	DOG & CAT FOOD & OTHER MISCELLANEOUS ITEMS	1	16.50	
INV 0000249425/11/2019		NORTHAM FEED & HIRE	DOG & CAT FOOD & OTHER MISCELLANEOUS ITEMS	1	16.50	
EFT35100	06/12/2019	NORTHAM FLORIST	WREATH FOR REMBERANCE DAY WREATHS NORTHAM AND BAKERS HILL	1		430.00
INV 22012	11/11/2019	NORTHAM FLORIST	FLOWERS PLUS DELIVER: MESSAGE: WISHING YOU A SPEEDY RECOVERY FROM ALL AT NORTHAM SHIRE.	1	100.00	
INV 22036	18/11/2019	NORTHAM FLORIST	WREATH FOR REMBERANCE DAY WREATHS NORTHAM AND BAKERS HILL	1	130.00	
INV 22053	21/11/2019	NORTHAM FLORIST	FLOWERS FOR FERNIHOUGH FAMILY	1	100.00	
INV 22054	21/11/2019	NORTHAM FLORIST	FLOWERS FOR FERNIHOUGH FAMILY FROM STAFF AND CREWS IN ENGINEERING SERVICES.	1	100.00	

Ordinary Council Meeting Minutes
22 January 2020

Date: 07/01/2020
Time: 8:12:43AM

Shire of Northam

USER: Kathy Scholz
PAGE: 19

Cheque /EFT No	Date	Name	Invoice Description	Bank Code	INV Amount	Amount
EFT35101	06/12/2019	NORTHAM HOLDEN	SUPPLY ASM-FRT SUSP 42502717 FOR PN1707 - REGO N11120	1		490.75
INV 126525	18/11/2019	NORTHAM HOLDEN	SUPPLY ASM-FRT SUSP 42502717 FOR PN1707 - REGO N11120	1	490.75	
EFT35102	06/12/2019	NORTHAM MAZDA	60KM SERVICE (MAJOR) SERVICE ON PN1407 REGO N10996	1		645.93
INV 126448	12/11/2019	NORTHAM MAZDA	60KM SERVICE (MAJOR) SERVICE ON PN1407 REGO N10996	1	645.93	
EFT35103	06/12/2019	NORTHAM MITRE 10 SOLUTIONS	PALLET OF GREY CEMENT (56 BAGS/PALLET)	1		3,812.89
INV 1046471702/10/2019		NORTHAM MITRE 10 SOLUTIONS	REPAIRS AND REVAMP TO A FRAME SINAGE BOARDS AT REC CENTRE.	1	119.72	
INV 1046496802/10/2019		NORTHAM MITRE 10 SOLUTIONS	PAINT PRODUCTS FOR COTTAGE BATHROOMS	1	229.41	
INV 1046461902/10/2019		NORTHAM MITRE 10 SOLUTIONS	SUMP DRAIN.	1	26.65	
INV 1046463202/10/2019		NORTHAM MITRE 10 SOLUTIONS	PIPE FITTINGS	1	54.61	
INV 1046540503/10/2019		NORTHAM MITRE 10 SOLUTIONS	SPRAY BOTTLES	1	28.13	
INV 1046685808/10/2019		NORTHAM MITRE 10 SOLUTIONS	LOW IMPACT SPRINKLERS OR BERNARD PARK PLAY CENTRE.	1	131.10	
INV 1046818611/10/2019		NORTHAM MITRE 10 SOLUTIONS	NORTHAM DEPOT, SUPPLY NEW TOILET SEAT & DISPOSIBLE GLOVES.	1	27.32	
INV 1046969815/10/2019		NORTHAM MITRE 10 SOLUTIONS	MAY STREET ROUND ABOUT - RETICULATION PARTS.	1	73.65	
INV 1046984716/10/2019		NORTHAM MITRE 10 SOLUTIONS	PALLET OF GREY CEMENT (56 BAGS/PALLET)	1	1,092.00	
INV 1046984316/10/2019		NORTHAM MITRE 10 SOLUTIONS	PULL CORD FOR EDGER.	1	19.48	
INV 1046984816/10/2019		NORTHAM MITRE 10 SOLUTIONS	METAL WATERING CAN FOR FLOCON TRUCK.	1	15.11	
INV 1047038917/10/2019		NORTHAM MITRE 10 SOLUTIONS	GALCON CONTRLLER FOR CEMETERY RETIC MAINTENANCE.	1	174.80	
INV 1047026117/10/2019		NORTHAM MITRE 10 SOLUTIONS	PIPE AND FITTINGS FOR RETICULATION AT ADMINISTRATION OFFICE	1	22.64	
INV 1047023617/10/2019		NORTHAM MITRE 10 SOLUTIONS	NUTS & BOLTS FOR QUICK CUT SAW.	1	7.24	
INV 1047023917/10/2019		NORTHAM MITRE 10 SOLUTIONS	WATER BOTTLE	1	186.00	
INV 1047073218/10/2019		NORTHAM MITRE 10 SOLUTIONS	SHACKLES FOR TRAILER.	1	30.98	

Ordinary Council Meeting Minutes
22 January 2020



Date: 07/01/2020
Time: 8:12:43AM

Shire of Northam

USER: Kathy Scholz
PAGE: 20

Cheque /EFT No	Date	Name	Invoice Description	Bank Code	INV Amount	Amount
INV 1047250122/10/2019		NORTHAM MITRE 10 SOLUTIONS	MAKITA CORDLESS DRILL 18V	1	309.00	
INV 1047230522/10/2019		NORTHAM MITRE 10 SOLUTIONS	TRESTLE TABLES	1	57.98	
INV 1047280723/10/2019		NORTHAM MITRE 10 SOLUTIONS	PLANTS/GIFTS FOR CITIZENSHIP CEREMONY ON 24/10/2019	1	171.49	
INV 1047257123/10/2019		NORTHAM MITRE 10 SOLUTIONS	SHED AT DEPOT FOR FIRE UNIT. SUPPLY 1 X LOCK BOX.	1	93.11	
INV 1047325424/10/2019		NORTHAM MITRE 10 SOLUTIONS	GRASS VALLEY 1.4 - RESTOCK TOOL LOCKER TO DFES SPECIFICATIONS	1	97.58	
INV 1047298924/10/2019		NORTHAM MITRE 10 SOLUTIONS	GALCON FOR "OLD" NORTHAM POOL GARDEN MAINTENANCE.	1	174.80	
INV 1047366925/10/2019		NORTHAM MITRE 10 SOLUTIONS	KARCHER VACUUM CLEANER	1	169.00	
INV 1047468228/10/2019		NORTHAM MITRE 10 SOLUTIONS	ASSORTED RETIC ITEMS FOR KILLARA	1	186.50	
INV 1047576231/10/2019		NORTHAM MITRE 10 SOLUTIONS	EVENTS WHEELIE BIN (BULK POWER CORDS)	1	66.03	
INV 1047579631/10/2019		NORTHAM MITRE 10 SOLUTIONS	LARGE WOOD DRILL BIT	1	36.58	
INV 1047594601/11/2019		NORTHAM MITRE 10 SOLUTIONS	1 X BOX OF SIGNET WHITE MARKING SPRAY PAINT	1	53.78	
INV 1047598401/11/2019		NORTHAM MITRE 10 SOLUTIONS	CUT KEYS X 3	1	21.38	
INV 1047723604/11/2019		NORTHAM MITRE 10 SOLUTIONS	WISTERIA FOR KING CREEK / PURSLOWE PARK TO REPLACE STOLEN.	1	37.25	
INV 1047733805/11/2019		NORTHAM MITRE 10 SOLUTIONS	SPRAY BOTTLE	1	73.11	
INV 1047833307/11/2019		NORTHAM MITRE 10 SOLUTIONS	NUTS AND BOLTS	1	26.46	
EFT35104	06/12/2019	NORTHAM VOLUNTEER FIRE AND RESCUE	FUEL LOAD REDUCTION - SHIRE LAND - ON CHIDLOW STREET NEAR WEST NORTHAM SCHOOL	1		700.00
INV 1011	26/11/2019	NORTHAM VOLUNTEER FIRE AND RESCUE	FUEL LOAD REDUCTION - SHIRE LAND - ON CHIDLOW STREET NEAR WEST NORTHAM SCHOOL	1	700.00	
EFT35105	06/12/2019	OCTAGON LIFTS PTY LTD	NORTHAM LIBRARY. 6 MONTHLY SERVICING OF LIFT.	1		655.60
INV 0002025528/10/2019		OCTAGON LIFTS PTY LTD	NORTHAM LIBRARY. 6 MONTHLY SERVICING OF LIFT.	1	655.60	
EFT35106	06/12/2019	OXTER SERVICES	CLEANING OF PUBLIC TOILETS - 12/11/2019 TO 23/11/2019.	1		4,885.31
INV 20563	23/11/2018	OXTER SERVICES	CLEANING OF PUBLIC TOILETS - 12/11/2019 TO 23/11/2019.	1	2,296.80	

Ordinary Council Meeting Minutes
22 January 2020

Date: 07/01/2020
Time: 8:12:43AM

Shire of Northam

USER: Kathy Scholz
PAGE: 21

Cheque /EFT No	Date	Name	Invoice Description	Bank Code	INV Amount	Amount
INV 21953	28/10/2019	OXTER SERVICES	VISITORS CENTRE. SUPPLY SLIMLINE HAND TOWEL AND 3 X TOILET PAPER.	1	291.71	
INV 22060	22/11/2019	OXTER SERVICES	CLEANING OF PUBLIC TOILETS - 11/11/2019 TO 22/11/2019.	1	2,296.80	
EFT35107	06/12/2019	PERTH SAFETY PRODUCTS PTY LTD	R4-1A.450 X 600MM SPEED RESTRICTION "10" ROUNDED CORNERS	1		1,703.90
INV 0000944829/10/2019		PERTH SAFETY PRODUCTS PTY LTD	"NO PARKING ON VERGE" LEFT ARROW SIGN	1	44.00	
INV 0000939305/11/2019		PERTH SAFETY PRODUCTS PTY LTD	R4-1A.450 X 600MM SPEED RESTRICTION "10" ROUNDED CORNERS	1	1,494.90	
INV 0000946106/11/2019		PERTH SAFETY PRODUCTS PTY LTD	STREET SIGN BLADE - 'SPENCERS BROOK RD'	1	55.00	
INV 0000946006/11/2019		PERTH SAFETY PRODUCTS PTY LTD	BLADE - 'TO GOOCH ROAD'	1	110.00	
EFT35108	06/12/2019	FED FOOD SERVICES PTY LTD	STOCK PURCHASES NORTHAM POOL	1		1,023.40
INV KR.7244008/11/2019		FED FOOD SERVICES PTY LTD	STOCK PURCHASES NORTHAM POOL	1	1,023.40	
EFT35110	06/12/2019	PRESTIGE ALARMS	ADMIN BUILDING. SUPPLY AND INSTALL REMOTE DOOR RELEASE AS PER QUOTE 00097075	1		3,834.60
INV S10855	24/10/2019	PRESTIGE ALARMS	ADMIN BUILDING. SUPPLY AND INSTALL REMOTE DOOR RELEASE AS PER QUOTE 00097075	1	2,877.60	
INV S10883	30/10/2019	PRESTIGE ALARMS	ADMIN BUILDING. REPLACE BATTERY BACK UP AND DO YEARLY MAINTENANCE INSPECTION.	1	957.00	
EFT35111	06/12/2019	PROFESSIONAL LOCKSERVICE	WUNDOWIE LIBRARY. SUPPLY 3 X C07 KEYS.	1		1,365.03
INV 0010430501/11/2019		PROFESSIONAL LOCKSERVICE	INKPEN REFUSE SITE. PLEASE SUPPLY 2 X EH2 PADLOCKS - STANDARD SHANK.	1	214.50	
INV 0010430601/11/2019		PROFESSIONAL LOCKSERVICE	WUNDOWIE LIBRARY. SUPPLY 3 X C07 KEYS.	1	639.03	
INV 0010430701/11/2019		PROFESSIONAL LOCKSERVICE	INSTALL 2 LOCKABLE DROP LOCKS ON DOOR AT THE NORTHAM REC CENTRE	1	511.50	
EFT35112	06/12/2019	PROGRAMME ELECTRICAL MAINTENANCE	WUNDOWIE LIBRARY REPLACE POWER POINT IN KITCHEN ARE, SWITCHES PRESSED IN.	1		61.60
INV 0000564730/10/2019		PROGRAMME ELECTRICAL MAINTENANCE	WUNDOWIE LIBRARY REPLACE POWER POINT IN KITCHEN ARE, SWITCHES PRESSED IN.	1	61.60	
EFT35113	06/12/2019	QUBE LOGISTICS	DELIVERY OF 920KG DRUM OF CHLORINE TO THE WASTE WATER.	1		835.86

Ordinary Council Meeting Minutes
22 January 2020

Date: 07/01/2020
Time: 8:12:43AM

Shire of Northam

USER: Kathy Scholz
PAGE: 22

Cheque /EFT No	Date	Name	Invoice Description	Bank Code	INV Amount	Amount
INV TS17513229/10/2019		QUBE LOGISTICS	DELIVERY OF 920KG DRUM OF CHLORINE TO THE WASTE WATER	1	835.86	
EFT35114	06/12/2019	RED DOT STORES	STOCK PURCHASES FOR LIBRARY	1		401.96
INV 4293350816/10/2019		RED DOT STORES	BE CONNECTED GRANT - GIFT BAGS AND ITEMS FOR SHOWBAGS	1	77.99	
INV 4301143422/10/2019		RED DOT STORES	STOCK PURCHASES FOR LIBRARY	1	158.47	
INV 4309625128/10/2019		RED DOT STORES	STOCK PURCHASES FOR LIBRARY	1	91.00	
INV 4332169513/11/2019		RED DOT STORES	STOCK PURCHASES FOR LIBRARY	1	74.50	
EFT35115	06/12/2019	REGIONAL PHYSIOTHERAPY & SPORTS INJURY CLINIC & IN BALANCE FITNESS	SENIOR SPORT FUNDING FOR COLIN EASTER	1		407.00
INV 0040365	30/10/2019	REGIONAL PHYSIOTHERAPY & SPORTS INJURY CLINIC & IN BALANCE FITNESS	SENIOR SPORT FUNDING FOR COLIN EASTER	1	110.00	
INV 0040571	04/11/2019	REGIONAL PHYSIOTHERAPY & SPORTS INJURY CLINIC & IN BALANCE FITNESS	SENIOR SPORT FUNDING	1	99.00	
INV 0040765	08/11/2019	REGIONAL PHYSIOTHERAPY & SPORTS INJURY CLINIC & IN BALANCE FITNESS	SENIOR SPORT FUNDING	1	99.00	
INV 0041448	27/11/2019	REGIONAL PHYSIOTHERAPY & SPORTS INJURY CLINIC & IN BALANCE FITNESS	SENIOR SPORT FUNDING	1	99.00	
EFT35116	06/12/2019	RETAIL DECISIONS (COLES)	COLES ACCOUNT FOR VARIOUS DEPARTMENTS - OCTOBER 2019.	1		4,405.79
INV OCTOBE31/10/2019		RETAIL DECISIONS (COLES)	COLES ACCOUNT FOR VARIOUS DEPARTMENTS - OCTOBER 2019.	1	4,405.79	
EFT35117	06/12/2019	ROAD AND TRAFFIC SERVICES PTY LTD	INSTALL PAVEMENT MARKINGS AS PER DRAWING SUPPLIED BY NADEEM 4 X GIVEWAYS, 1 X STENCIL QUOTE 20CP008	1		605.00
INV 0000805727/11/2019		ROAD AND TRAFFIC SERVICES PTY LTD	INSTALL PAVEMENT MARKINGS AS PER DRAWING SUPPLIED BY NADEEM 4 X GIVEWAYS, 1 X STENCIL QUOTE 20CP008	1	605.00	
EFT35118	06/12/2019	ROBERT WAYNE TINETTI	COUNCILLOR PAYMENTS NOVEMBER 2019	1		1,905.73
INV NOVEME0/11/2019		ROBERT WAYNE TINETTI	COUNCILLOR PAYMENTS NOVEMBER 2019	1	1,905.73	

Ordinary Council Meeting Minutes
22 January 2020



Date: 07/01/2020
Time: 8:12:43AM

Shire of Northam

USER: Kathy Scholz
PAGE: 23

Cheque /EFT No	Date	Name	Invoice Description	Bank Code	INV Amount	Amount
EFT35119	06/12/2019	ROYAL LIFE SAVING SOCIETY WA	LIFEGUARD TRAINING FOR STAFF.	1		1,113.00
INV 107309	16/10/2019	ROYAL LIFE SAVING SOCIETY WA	LIFEGUARD TRAINING FOR STAFF.	1	318.00	
INV 107309	16/10/2019	ROYAL LIFE SAVING SOCIETY WA	LIFEGUARD TRAINING FOR STAFF	1	318.00	
INV 107308	16/10/2019	ROYAL LIFE SAVING SOCIETY WA	LIFEGUARD TRAINING FOR STAFF	1	159.00	
INV 107308	16/10/2019	ROYAL LIFE SAVING SOCIETY WA	LIFEGUARD TRAINING	1	159.00	
INV 108589	19/11/2019	ROYAL LIFE SAVING SOCIETY WA	LIFEGUARD REQUAL - BROOKE JUPP	1	159.00	
EFT35120	06/12/2019	SLAVS CLEANING SERVICE	CLEANING OF APEX PARK & BERNARD PARK TOILETS.	1		2,936.81
INV 35	28/10/2019	SLAVS CLEANING SERVICE	URGENT EXTRA CLEAN OF BENARD PARK TOILETS	1	165.00	
INV 35	28/10/2019	SLAVS CLEANING SERVICE	CLEANING OF APEX PARK & BERNARD PARK TOILETS.	1	2,771.81	
EFT35121	06/12/2019	SOLAR LIGHTING DESIGNS	SUPPLY SOLAR WALL/POST LIGHT	1		748.00
INV I67953	24/10/2019	SOLAR LIGHTING DESIGNS	SUPPLY SOLAR WALL/POST LIGHT	1	748.00	
EFT35122	06/12/2019	SOUTHERN CROSS AUSTEREO PTY LTD	AROUND THE TOWNS 2019/20 - SHIRE PRESIDENT INTERVIEWS	1		88.00
INV 7093610531/10/2019		SOUTHERN CROSS AUSTEREO PTY LTD	AROUND THE TOWNS 2019/20 - SHIRE PRESIDENT INTERVIEWS	1	88.00	
EFT35123	06/12/2019	ST JOHN AMBULANCE AUSTRALIA (WA) INC.	GRASS VALLEY BFB PREMISES - ANNUAL FIRST AID KIT SERVICING	1		1,348.09
INV FAINV0007/11/2019		ST JOHN AMBULANCE AUSTRALIA (WA) INC.	FIRST AID COURSE - JACK JUPP	1	133.00	
INV FAINV0007/11/2019		ST JOHN AMBULANCE AUSTRALIA (WA) INC.	FIRST AID COURSE - DIANNE JUPP	1	133.00	
INV CYINV0019/11/2019		ST JOHN AMBULANCE AUSTRALIA (WA) INC.	BAKERS HILL BFB PREMISES - ANNUAL FIRST AID KIT SERVICING	1	151.65	
INV CYINV0019/11/2019		ST JOHN AMBULANCE AUSTRALIA (WA) INC.	CLACKLINE/MURESK BFB PREMISES - ANNUAL FIRST AID KIT SERVICING	1	159.62	
INV CYINV0019/11/2019		ST JOHN AMBULANCE AUSTRALIA (WA) INC.	SHIRE OF NORTHAM BFB PREMISES - ANNUAL FIRST AID KIT SERVICING	1	85.01	
INV CYINV0019/11/2019		ST JOHN AMBULANCE AUSTRALIA (WA) INC.	GRASS VALLEY BFB PREMISES - ANNUAL FIRST AID KIT SERVICING	1	383.58	

Ordinary Council Meeting Minutes
22 January 2020

Date: 07/01/2020
Time: 8:12:43AM

Shire of Northam

USER: Kathy Scholz
PAGE: 24

Cheque /EFT No	Date	Name	Invoice Description	Bank Code	INV Amount	Amount
INV CYINV0019/11/2019		ST JOHN AMBULANCE AUSTRALIA (WA) INC.	INKPEN BFB PREMISES - ANNUAL FIRST AID KIT SERVICING	1	136.19	
INV CYINV0019/11/2019		ST JOHN AMBULANCE AUSTRALIA (WA) INC.	SOUTHERN BROOK BFB PREMISES - ANNUAL FIRST AID KIT SERVICING	1	166.04	
EFT35124	06/12/2019	STEPHEN CARRICK ARCHITECTS	CREATE PLACE 4 RECORD FORMS FOR PROPOSED HERITAGE LIST	1		2,794.00
INV 7238	28/11/2019	STEPHEN CARRICK ARCHITECTS	CREATE PLACE 4 RECORD FORMS FOR PROPOSED HERITAGE LIST	1	2,794.00	
EFT35125	06/12/2019	STEVEN BRUCE POLLARD	COUNCILLOR PAYMENTS NOVEMBER 2019	1		1,905.73
INV NOVEME30/11/2019		STEVEN BRUCE POLLARD	COUNCILLOR PAYMENTS NOVEMBER 2019	1	1,905.73	
EFT35126	06/12/2019	STEVEN ROBERT ELKINGTON	RETURN OF BOND #4125	1		100.00
INV #4125	15/11/2019	STEVEN ROBERT ELKINGTON	RETURN OF BOND #4125	1	100.00	
EFT35127	06/12/2019	STEWART & HEATON CLOTHING CO.PTY LTD	PPE EQUIPMENT FOR BUSHFIRES.	1		990.79
INV SIN-312404/11/2019		STEWART & HEATON CLOTHING CO.PTY LTD	PPE EQUIPMENT FOR BUSHFIRES.	1	990.79	
EFT35128	06/12/2019	SWAN EVENT HIRE	FENCING FOR 2019 CHRISTMAS DECORATIONS	1		2,465.00
INV 14368	28/11/2019	SWAN EVENT HIRE	FENCING FOR 2019 CHRISTMAS DECORATIONS	1	2,465.00	
EFT35129	06/12/2019	T/AS AVON VALLEY NISSAN & MITSUBISHI AVN NORTHAM PTY LTD	80,000KM SERVICE OF REGO N11254 (PN1517) BOOKED FRIDAY 25/10/2019 8AM	1		446.81
INV 338035	25/10/2019	T/AS AVON VALLEY NISSAN & MITSUBISHI AVN NORTHAM PTY LTD	80,000KM SERVICE OF REGO N11254 (PN1517) BOOKED FRIDAY 25/10/2019 8AM	1	446.81	
EFT35130	06/12/2019	TANIA LOUISE VINSON	PRIZE DONATED BY SPECIALISED TREE SERVICES FOR EARLY RATES INCENTIVE - A.13964	1		1,000.00
INV CY2111201/11/2019		TANIA LOUISE VINSON	PRIZE DONATED BY SPECIALISED TREE SERVICES FOR EARLY RATES INCENTIVE - A.13964	1	1,000.00	
EFT35131	06/12/2019	TERRY MATTHEW LITTLE	COUNCILLOR PAYMENTS NOVEMBER 2019	1		2,012.29
INV NOVEME30/11/2019		TERRY MATTHEW LITTLE	COUNCILLOR PAYMENTS NOVEMBER 2019	1	2,012.29	

Ordinary Council Meeting Minutes
22 January 2020

Date: 07/01/2020
Time: 8:12:43AM

Shire of Northam

USER: Kathy Scholz
PAGE: 25

Cheque /EFT No	Date	Name	Invoice Description	Bank Code	INV Amount	Amount
EFT35132	06/12/2019	THE LIMES ORCHARD STAY - PT & JA PERKINS	STOCK PURCHASES FOR VISITORS CENTRE.	1		51.60
INV 0000102016/11/2019		THE LIMES ORCHARD STAY - PT & JA PERKINS	STOCK PURCHASES FOR VISITORS CENTRE.	1	51.60	
EFT35133	06/12/2019	THE LION'S CLUB OF NORTHAM	MANAGING BAR FOR 2019 VOLUNTEER EMERGENCY SERVICES VOLUNTEER DAY	1		500.00
INV 27	20/11/2019	THE LION'S CLUB OF NORTHAM	MANAGING BAR FOR 2019 VOLUNTEER EMERGENCY SERVICES VOLUNTEER DAY	1	500.00	
EFT35134	06/12/2019	THE WORKWEAR GROUP	UNIFORMS FOR JACKY JURMANN	1		384.35
INV 1187086520/11/2019		THE WORKWEAR GROUP	UNIFORMS FOR JACKY JURMANN	1	384.35	
EFT35135	06/12/2019	TIA HUNT	REIMBURSEMENT FOR POOL LIFEGUARD AND FIRST AID COURSE	1		439.10
INV 103932/10/09/07/2019		TIA HUNT	REIMBURSEMENT FOR POOL LIFEGUARD AND FIRST AID COURSE	1	384.00	
INV 2524500	22/11/2019	TIA HUNT	REIMBURSEMENT FOR POLICE CLEARANCE	1	55.10	
EFT35136	06/12/2019	TOLL TRANSPORT PTY LTD	TOLL FREIGHT CHARGES OCT 2019	1		682.78
INV 0413-S3028/07/2019		TOLL TRANSPORT PTY LTD	TOLL FREIGHT CHARGES JUL 2019	1	186.34	
INV 0414-S3004/08/2019		TOLL TRANSPORT PTY LTD	TOLL FREIGHT CHARGES AUG 2019	1	72.22	
INV 0421-S3029/09/2019		TOLL TRANSPORT PTY LTD	TOLL FREIGHT CHARGES SEP 2019	1	127.05	
INV 0422-S3006/10/2019		TOLL TRANSPORT PTY LTD	TOLL FREIGHT CHARGES OCT 2019	1	250.97	
INV 0426-S3003/11/2019		TOLL TRANSPORT PTY LTD	TOLL FREIGHT CHARGES NOV 2019	1	46.20	
EFT35137	06/12/2019	TOTAL EDEN	SPRINKLERS FOR VARIOUS OVALS	1		1,919.61
INV 4094333520/11/2019		TOTAL EDEN	SPRINKLERS FOR VARIOUS OVALS	1	1,919.61	
EFT35138	06/12/2019	TOTAL GREEN RECYCLING PTY LTD	RECYCLING AND TRANSFER OF E-WASTE FROM OLD QUARRY LAND FILL	1		2,551.56
INV INV6783 30/11/2019		TOTAL GREEN RECYCLING PTY LTD	RECYCLING AND TRANSFER OF E-WASTE FROM OLD QUARRY LAND FILL	1	2,551.56	

Ordinary Council Meeting Minutes
22 January 2020



Date: 07/01/2020
Time: 8:12:43AM

Shire of Northam

USER: Kathy Scholz
PAGE: 26

Cheque /EFT No	Date	Name	Invoice Description	Bank Code	INV Amount	Amount
EFT35139	06/12/2019	TOTAL PACKAGING	BOXES OF DOGGY DUMPAGE BAGS	1		514.80
INV 0000343413/11/2019		TOTAL PACKAGING	BOXES OF DOGGY DUMPAGE BAGS	1	514.80	
EFT35140	06/12/2019	TRANSWEST WA AUSTRALIAN STONE COMPANY PTY LTD	GRAVEL - MRWA SPEC - DELIVERED TO SLK 0.4 WAMBYN RD	1		2,176.75
INV INV-040731/10/2019		TRANSWEST WA AUSTRALIAN STONE COMPANY PTY LTD	GRAVEL - MRWA SPEC - DELIVERED TO SLK 0.4 WAMBYN RD	1	2,176.75	
EFT35142	06/12/2019	WARRICKS NEWSAGENCY	STATIONARY FOR ADMIN	1		882.83
INV SN0001730/09/2019		WARRICKS NEWSAGENCY	NEWSPAPERS FOR KILLARA	1	42.10	
INV 55994	10/10/2019	WARRICKS NEWSAGENCY	STATIONARY FOR ADMIN	1	545.25	
INV SN0001731/10/2019		WARRICKS NEWSAGENCY	LIBRARY - MAGAZINE SUBSCRIPTIONS OCTOBER 2019	1	157.68	
INV SN0000631/10/2019		WARRICKS NEWSAGENCY	NEWSPAPERS FOR ADMIN - OCTOBER 2019.	1	90.70	
INV SN0001731/10/2019		WARRICKS NEWSAGENCY	KILLARA - NEWSPAPER COPIES	1	47.10	
EFT35143	06/12/2019	WATTLEUP TRACTORS	PARTS FOR FLAIL MOWER TRIMAX WARLORD.	1		962.35
INV 1258438	26/10/2019	WATTLEUP TRACTORS	PARTS FOR FLAIL MOWER TRIMAX WARLORD.	1	962.35	
EFT35144	06/12/2019	WESTWIDE AUTO ELECTRICS AND AIR CONDITIONING	REPLACE BROKEN WIRING HARNESS IN STEEL DRUM ROLLER PN1006	1		1,750.00
INV INV-964202/09/2019		WESTWIDE AUTO ELECTRICS AND AIR CONDITIONING	SUPPLY AND FIT NEW ANTANNA.PLUS FIND LEAK AND FIX IN PN1502	1	450.00	
INV INV-964619/11/2019		WESTWIDE AUTO ELECTRICS AND AIR CONDITIONING	REPLACE BROKEN WIRING HARNESS IN STEEL DRUM ROLLER PN1006	1	1,300.00	
EFT35145	06/12/2019	WHEATBELT OFFICE & BUSINESS MACHINES	Brother HL-L5200DN printer	1		435.50
INV 25401	15/10/2019	WHEATBELT OFFICE & BUSINESS MACHINES	10 METRE CATSE CABLE	1	12.30	
INV 25494	06/11/2019	WHEATBELT OFFICE & BUSINESS MACHINES	Brother HL-L5200DN printer	1	289.00	
INV 25577	27/11/2019	WHEATBELT OFFICE & BUSINESS MACHINES	MICROSOFT WIRED DESKTOP 600 KEYBOARD + MOUSE	1	134.20	

Ordinary Council Meeting Minutes
22 January 2020

Date: 07/01/2020
Time: 8:12:43AM

Shire of Northam

USER: Kathy Scholz
PAGE: 27

Cheque /EFT No	Date	Name	Invoice Description	Bank Code	INV Amount	Amount
EFT35146	06/12/2019	WHEATBELT SAFETYWEAR	FWP HARNESS & OVERALLS	1		437.50
INV 9114	02/11/2019	WHEATBELT SAFETYWEAR	ROB WILSON - BOOTS	1	150.00	
INV 9115	04/11/2019	WHEATBELT SAFETYWEAR	FWP HARNESS & OVERALLS	1	287.50	
EFT35147	06/12/2019	BEVERLEY ANN JONES	REIMBURSEMENT FOR HEP A/B VACCINATION.	1		75.99
INV 51399F	05/12/2019	BEVERLEY ANN JONES	REIMBURSEMENT FOR HEP A/B VACCINATION.	1	75.99	
EFT35148	06/12/2019	SPECIALISED TREE SERVICE	8 HOPETOUN AVE - PRUNE CLEAN UP	1		1,347.10
INV 3195	02/12/2019	SPECIALISED TREE SERVICE	8 HOPETOUN AVE - PRUNE CLEAN UP	1	1,347.10	
EFT35149	06/12/2019	WA CONTRACT RANGER SERVICES	RANGER SERVICES/FIREBREAK INSPECTIONS 1/09/19 - 15/11/19 @ \$60.50P/H	1		14,074.50
INV 02409	07/11/2019	WA CONTRACT RANGER SERVICES	RANGER SERVICES ON CALL - 28/10/2019 TO 01/11/2019.	1	2,722.50	
INV 02415	16/11/2019	WA CONTRACT RANGER SERVICES	RANGER SERVICES/FIREBREAK INSPECTIONS 1/09/19 - 15/11/19 @ \$60.50P/H	1	5,989.50	
INV 02416	18/11/2019	WA CONTRACT RANGER SERVICES	POUND DUTIES (WEEKLY) - OCTOBER AND NOVEMBER	1	1,380.50	
INV 02443	01/12/2019	WA CONTRACT RANGER SERVICES	RANGERS SERVICES/FIREBREAK INSPECTIONS 25TH - 29TH NOVEMBER	1	2,601.50	
INV 02446	03/12/2019	WA CONTRACT RANGER SERVICES		1	1,380.50	
EFT35150	06/12/2019	WESTERN AUSTRALIAN TREASURY CORPORATION	Loan No. 219A Interest payment - BOWLING CLUB DEVELOPMENT 2016	1		12,302.77
INV 219A	02/12/2019	WESTERN AUSTRALIAN TREASURY CORPORATION	Loan No. 219A Interest payment - BOWLING CLUB DEVELOPMENT 2016		12,302.77	
EFT35151	12/12/2019	ACCENT RUBBER STAMPS AND TROPHIES	PRE-INKED STAMP - "INVOICE AUTHORISED FOR PAYMENT"	1		97.75
INV 0006372929/11/2019		ACCENT RUBBER STAMPS AND TROPHIES	PRE-INKED STAMP - "INVOICE AUTHORISED FOR PAYMENT"	1	97.75	
EFT35152	12/12/2019	ADVANCED TRAFFIC MANAGEMENT (WA) PTY LTD	SUPPLY OF TWO X TRAFFIC MANAGEMENT PERSONNEL FOR SHOULDER PREP COATES ROAD WUNDOWIE AS PER QUOTE	1		950.95

Ordinary Council Meeting Minutes
22 January 2020



Date: 07/01/2020
Time: 8:12:43AM

Shire of Northam

USER: Kathy Scholz
PAGE: 28

Cheque /EFT No	Date	Name	Invoice Description	Bank Code	INV Amount	Amount
INV 0013123712/11/2019		ADVANCED TRAFFIC MANAGEMENT (WA) PTY LTD	SUPPLY OF TWO X TRAFFIC MANAGEMENT PERSONNEL FOR SHOULDER PREP COATES ROAD WUNDOWIE AS PER QUOTE	1	950.95	
EFT35153	12/12/2019	AQUATIC SERVICES WA PTY LTD	SUPPLY ASTRAL BX 3.0 POOL PUMP AS PER QUOTE #ASQ20190479	1		1,338.70
INV AS#2017114/11/2019		AQUATIC SERVICES WA PTY LTD	SUPPLY ASTRAL BX 3.0 POOL PUMP AS PER QUOTE #ASQ20190479	1	1,338.70	
EFT35154	12/12/2019	AUSTRALIAN INSTITUTE OF MANAGEMENT WESTERN AUSTRALIA	CANCELLATION FEE - EXCEL COURSE	1		229.50
INV 7118869	19/11/2019	AUSTRALIAN INSTITUTE OF MANAGEMENT WESTERN AUSTRALIA	CANCELLATION FEE - EXCEL COURSE	1	229.50	
EFT35155	12/12/2019	AUSTRALIAN PAPER	x 4000 WINDOW FACED ENVELOPES 140034	1		167.99
INV 9622123714/11/2019		AUSTRALIAN PAPER	x 4000 WINDOW FACED ENVELOPES 140034	1	167.99	
EFT35156	12/12/2019	AV-SEC SECURITY SERVICES	ALARM RESPONSE AT CREATE 298 12/11/2019	1		65.00
INV 2111	23/11/2019	AV-SEC SECURITY SERVICES	ALARM RESPONSE AT CREATE 298 12/11/2019	1	65.00	
EFT35157	12/12/2019	AVON SERVICE SPECIALISTS	HEAVY ANNUAL SERVICE FOR CLACKLINE 2.4 - REGO 1CIG-323 SEE ATTACHED INSPECTION FORMS AS PER QUOTED	1		7,645.10
INV 17674	01/11/2019	AVON SERVICE SPECIALISTS		1	1,262.85	
INV 17688	04/11/2019	AVON SERVICE SPECIALISTS	HEAVY ANNUAL SERVICE FOR GRASS VALLEY 4.4 - REGO 1GAZ650 SEE ATTACHED INSPECTION FORMS AS PER QUOTED	1	1,183.20	
INV 17699	06/11/2019	AVON SERVICE SPECIALISTS	HEAVY ANNUAL SERVICE FOR GRASS VALLEY 4.4 - REGO 1GAZ650 SEE ATTACHED INSPECTION FORMS AS PER QUOTED	1	1,025.95	
INV 17708	07/11/2019	AVON SERVICE SPECIALISTS	HEAVY ANNUAL SERVICE FOR CLACKLINE 2.4 - REGO 1CIG-323 SEE ATTACHED INSPECTION FORMS AS PER QUOTED	1	1,598.65	
INV 17773	19/11/2019	AVON SERVICE SPECIALISTS	REPLACE WORN SHACKLES - DT-200036 DRIVETECH 4X4 LEAF SPRING CHACKLE - GREASABLE - CLACKLINE LT1 REGO 1DJA-799	1	765.25	

Ordinary Council Meeting Minutes
22 January 2020

Date: 07/01/2020
Time: 8:12:43AM

Shire of Northam

USER: Kathy Scholz
PAGE: 29

Cheque /EFT No	Date	Name	Invoice Description	Bank Code	INV Amount	Amount
INV 17808	25/11/2019	AVON SERVICE SPECIALISTS	ANNUAL HEAVY SERVICE OF GRASS VALLEY 1.4 ISUZU TRUCK -REGO 1DWZ-147 AS PER ATTACHED FORMS INCLUDING AIRCOND. PLEASE CALL AT TIME OF INSPECTION FOR EXTRA REPAIRS- IF POSSIBLE NEED TO BE DONE ON DAY.	1	1,257.60	
INV 17837	29/11/2019	AVON SERVICE SPECIALISTS	50,000KM SERVICE ON PN1710 - REGO N79 PLEASE ADJUST HEADLIGHTS SLIGHTLY DOWN	1	306.30	
INV 17850	02/12/2019	AVON SERVICE SPECIALISTS	90,000 KM SERVICE PN1309 - REGO N4098 ALSO CHECK BRAKES	1	245.30	
EFT35158	12/12/2019	AVON WASTE	RUBBISH COLLECTION FOR NOV 2019	1		75,141.59
INV 36407	08/11/2019	AVON WASTE	FORTNIGHTLY RUBBISH COLLECTION NOV 2019	1	37,441.12	
INV 36428	22/11/2019	AVON WASTE	RUBBISH COLLECTION FOR NOV 2019	1	37,700.47	
EFT35159	12/12/2019	AVONVALE EDUCATION SUPPORT CENTRE	SCHOOL PRIZE AND DONATION 2019	1		200.00
INV 419	03/12/2019	AVONVALE EDUCATION SUPPORT CENTRE	SCHOOL PRIZE AND DONATION 2019	1	200.00	
EFT35160	12/12/2019	AVONVALE PRIMARY SCHOOL	2019 END OF YEAR BOOK AWARDS	1		200.00
INV 1759	03/12/2019	AVONVALE PRIMARY SCHOOL	2019 END OF YEAR BOOK AWARDS	1	200.00	
EFT35161	12/12/2019	BEAUREPAIRES	REPLACE 2 X 99 215/70R16LT 108/106T CENTARA COMM TYRE AND WHEEL ALIGNMENT AS PER QUOTE US24106855 FOR PN1516 - REGO N11196	1		401.32
INV U52435731/10/2019		BEAUREPAIRES	REPLACE 2 X 99 215/70R16LT 108/106T CENTARA COMM TYRE AND WHEEL ALIGNMENT AS PER QUOTE US24106855 FOR PN1516 - REGO N11196	1	401.32	
EFT35162	12/12/2019	BLACKWELL PLUMBING PTY LTD	TANK AT 105 CHITTY ROAD, BAKERS HILL - INITIAL VISIT TO CHECK FLOAT VALVE - LABOUR & TRAVEL	1		1,095.15
INV INV-203331/10/2019		BLACKWELL PLUMBING PTY LTD	NORTHAM DEPOT. PLEASE REPAIR HWS, NOT HEATING.	1	189.75	
INV INV-203404/11/2019		BLACKWELL PLUMBING PTY LTD	CHECK AND REPORT ON LEAK AT CLARKE ST, AND ADVISE ON REPAIR	1	99.00	
INV INV-203914/11/2019		BLACKWELL PLUMBING PTY LTD	TANK AT 105 CHITTY ROAD, BAKERS HILL - INITIAL VISIT TO CHECK FLOAT VALVE - LABOUR & TRAVEL	1	707.40	

Ordinary Council Meeting Minutes
22 January 2020

Date: 07/01/2020
Time: 8:12:43AM

Shire of Northam

USER: Kathy Scholz
PAGE: 30

Cheque /EFT No	Date	Name	Invoice Description	Bank Code	INV Amount	Amount
INV INV-203814/11/2019		BLACKWELL PLUMBING PTY LTD	VISITORS CENTRE REPORT ON FLOOR WASTES SMELLING THROUOUT TOIETS AND CAFE KITCHEN.	1	99.00	
EFT35163	12/12/2019	BUILDER'S REGISTRATION BOARD OF WA	MONTHLY BSL FEES COLLECTED FOR THE BUILDING COMMISSION FOR THE MONTH OF NOVEMBER 2019.	1		3,711.66
INV T1080	11/12/2019	BUILDER'S REGISTRATION BOARD OF WA	MONTHLY BSL FEES COLLECTED FOR THE BUILDING COMMISSION FOR THE MONTH OF NOVEMBER 2019.	1	3,711.66	
EFT35164	12/12/2019	BUILDING AND CONSTRUCTION INDUSTRY TRAINING FUND	MONTHLY BCITF FEES COLLECTED FOR THE CONSTRUCTION TRAINING FUND FOR THE MONTH OF NOVEMBER 2019.	1		199.50
INV T1079	11/12/2019	BUILDING AND CONSTRUCTION INDUSTRY TRAINING FUND	MONTHLY BCITF FEES COLLECTED FOR THE CONSTRUCTION TRAINING FUND FOR THE MONTH OF NOVEMBER 2019.	1	199.50	
EFT35165	12/12/2019	CENTRAL MOBILE MECHANICAL REPAIRS	ANNUAL HEAVY SERVICE OF CENTRAL 2.4 REGO 1BMR-019 - INCLUDING AIRCON CHECK. PLEASE CALL FOR ANY EXTRA WORK REQUIRED AS IF POSSIBLE NEED TO BE DONE ON THE DAY.	1		7,283.48
INV 0000297406/12/2019		CENTRAL MOBILE MECHANICAL REPAIRS	LIGHT ANNUAL SERVICE FOR BAKERS HILL LT - REGO 1EEJ-949 SEE ATTACHED FORMS PRICE AS PER QUOTE	1	1,137.24	
INV 0000297106/12/2019		CENTRAL MOBILE MECHANICAL REPAIRS	ANNUAL HEAVY SERVICE OF IRISHTOWN 1.4 ISUZU TRUCK - REGO N.2501 SEE ATTACHED FORMS	1	1,466.40	
INV 0000297006/12/2019		CENTRAL MOBILE MECHANICAL REPAIRS	ANNUAL HEAVY SERVICE INKPEN 3.4 ISUZU TRUCK - REGO N.3113 SEE ATTACHED FORMS	1	462.00	
INV 0000297306/12/2019		CENTRAL MOBILE MECHANICAL REPAIRS	ANNUAL LIGHT SERVICE OF WUNDOWIE LT LANDCRUISER - REGO 1DZ1-553 SEE ATTACHED FORMS	1	1,179.64	
INV 0000297206/12/2019		CENTRAL MOBILE MECHANICAL REPAIRS	ANNUAL HEAVY SERVICE OF CENTRAL 2.4 REGO 1BMR-019 - INCLUDING AIRCON CHECK. PLEASE CALL FOR ANY EXTRA WORK REQUIRED AS IF POSSIBLE NEED TO BE DONE ON THE DAY.	1	1,863.51	
INV 0000297506/12/2019		CENTRAL MOBILE MECHANICAL REPAIRS	LIGHT ANNUAL SERVICE FOR INKPEN LT LANDCRUISER -REGO 1GBO-744 SEE ATTACHED FORMS	1	1,174.69	
EFT35166	12/12/2019	CHRISTOPHER RICHARD ANTONIO	EAST WARD CANDIDATE NOMINATION 2019 SHIRE OF NORTHAM	1		80.00
INV T1217	11/12/2019	CHRISTOPHER RICHARD ANTONIO	EAST WARD CANDIDATE NOMINATION 2019 SHIRE OF NORTHAM	1	80.00	

Ordinary Council Meeting Minutes
22 January 2020

Date: 07/01/2020
Time: 8:12:43AM

Shire of Northam

USER: Kathy Scholz
PAGE: 31

Cheque /EFT No	Date	Name	Invoice Description	Bank Code	INV Amount	Amount
EFT35167	12/12/2019	CLIFFORD ROY BARRETT	INFRASTRUCTURE BOND REFUND FOR BLDG APPLICATION NO.19175 R#128390.	1		1,000.00
INV T1240	11/12/2019	CLIFFORD ROY BARRETT	INFRASTRUCTURE BOND REFUND FOR BLDG APPLICATION NO.19175 R#128390.	1	1,000.00	
EFT35168	12/12/2019	COLE HAZLEWOOD	INFRASTRUCTURE BOND REFUND FOR BLDG PERMIT NO 13193 R#62458.	1		1,022.69
INV T676	11/12/2019	COLE HAZLEWOOD	INFRASTRUCTURE BOND REFUND FOR BLDG PERMIT NO 13193 R#62458.	1	1,022.69	
EFT35169	12/12/2019	COMBINED TYRES	PUNTURE REPAIR TO WUNDOWIE LT LANDCRUISER - REGO 1DZ1-553	1		66.00
INV INV-329808/11/2019		COMBINED TYRES	PUNTURE REPAIR TO WUNDOWIE LT LANDCRUISER - REGO 1DZ1-553	1	66.00	
EFT35170	12/12/2019	COUNTRYWIDE GROUP	CHEMICALS FOR WUNDOWIE SWIMMING POOL.	1		1,512.95
INV 28546	03/12/2019	COUNTRYWIDE GROUP	CHEMICALS FOR WUNDOWIE SWIMMING POOL.	1	1,248.39	
INV 28545	03/12/2019	COUNTRYWIDE GROUP	CHLORINE FOR WATER PARK	1	264.56	
EFT35171	12/12/2019	CREATIVE TUCKPOINTING	NORTHAM LIBRARY. CARRY OUT STRUCTURAL REPAIRS AS PER ENGINEER'S REPORT AND AS PER QUOTE 0305.	1		1,500.00
INV 0310	22/11/2019	CREATIVE TUCKPOINTING	NORTHAM LIBRARY. CARRY OUT STRUCTURAL REPAIRS AS PER ENGINEER'S REPORT AND AS PER QUOTE 0305.	1	1,500.00	
EFT35172	12/12/2019	CTI SECURITY SYSTEMS PTY LTD T/AS SECURUS	OLD GIRLS SCHOOL. REPAIR SENSOR SHOWING ERROR.	1		220.08
INV 116613	24/11/2019	CTI SECURITY SYSTEMS PTY LTD T/AS SECURUS	OLD GIRLS SCHOOL. REPAIR SENSOR SHOWING ERROR.	1	220.08	
EFT35173	12/12/2019	DAVID JAMES GALLOWAY	WEST WARD CANDIDATE NOMINATION 2019 SHIRE OF NORTHAM	1		80.00
INV T1213	11/12/2019	DAVID JAMES GALLOWAY	WEST WARD CANDIDATE NOMINATION 2019 SHIRE OF NORTHAM	1	80.00	
EFT35174	12/12/2019	DENTS GRAHAM BERESFORD	TOWN WARD CANDIDATE NOMINATION 2019 SHIRE OF NORTHAM	1		80.00
INV T1226	11/12/2019	DENTS GRAHAM BERESFORD	TOWN WARD CANDIDATE NOMINATION 2019 SHIRE OF NORTHAM	1	80.00	

Ordinary Council Meeting Minutes
22 January 2020

Date: 07/01/2020
Time: 8:12:43AM

Shire of Northam

USER: Kathy Scholz
PAGE: 32

Cheque /EFT No	Date	Name	Invoice Description	Bank Code	INV Amount	Amount
EFT35175	12/12/2019	DESMOND ARNOLD HUGHES	TOWN WARD NOMINATION 2019 SHIRE OF NORTHAM	1		80.00
INV T1218	11/12/2019	DESMOND ARNOLD HUGHES	TOWN WARD NOMINATION 2019 SHIRE OF NORTHAM	1	80.00	
EFT35176	12/12/2019	DRACO AIR PTY LTD	SOUTHERN BROOK HALL. SUPPL AND INSTALL 3.5 KW WALL SPLIT A S PER QUOTE DA-12184.	1		2,778.84
INV DA-1218-21/11/2019		DRACO AIR PTY LTD	SOUTHERN BROOK HALL. SUPPL AND INSTALL 3.5 KW WALL SPLIT A S PER QUOTE DA-12184.	1	2,778.84	
EFT35177	12/12/2019	DUNNING INVESTMENTS PTY LTD	FUEL CHARGES FOR NOVEMBER 2019	1		29,715.99
INV NOVEME11/12/2019		DUNNING INVESTMENTS PTY LTD	FUEL CHARGES FOR NOVEMBER 2019	1	29,715.99	
EFT35178	12/12/2019	EQUIFAX AUSTRALASIA WORKFORCE SOLUTIONS PTY LTD	AUSTRALIAN CRIMINAL HISTORY CHECK (E)	1		143.88
INV 1449330930/11/2019		EQUIFAX AUSTRALASIA WORKFORCE SOLUTIONS PTY LTD	AUSTRALIAN CRIMINAL HISTORY CHECK (E)	1	143.88	
EFT35179	12/12/2019	GAVIN CURRIE	WEST WARD CANDIDATE NOMINATION 2019 SHIRE OF NORTHAM	1		80.00
INV T1228	11/12/2019	GAVIN CURRIE	WEST WARD CANDIDATE NOMINATION 2019 SHIRE OF NORTHAM	1	80.00	
EFT35180	12/12/2019	GLENN STUART BEVERIDGE	PICK UP 18 SIGNS AND 14 POST/BRACKETS AND IN STALL AT OLD QUARRY ROAD WASTE MANAGEMENT INCLUDING DIGGING OF HOLES AND CONCRETE	1		1,221.00
INV 38	05/12/2019	GLENN STUART BEVERIDGE	PICK UP 18 SIGNS AND 14 POST/BRACKETS AND IN STALL AT OLD QUARRY ROAD WASTE MANAGEMENT INCLUDING DIGGING OF HOLES AND CONCRETE	1	1,155.00	
INV 42	06/12/2019	GLENN STUART BEVERIDGE	BKB CENTRE. GAIN ACCESS TO ROOF TO CHECK ON SOLAR PANELS.	1	66.00	
EFT35181	12/12/2019	GROVE WESLEY DESIGN ART	2 BOXES BUSINESS CARDS - KILLARA	1		104.50
INV 5778	18/11/2019	GROVE WESLEY DESIGN ART	2 BOXES BUSINESS CARDS - KILLARA	1	104.50	
EFT35182	12/12/2019	HWL EBSWORTH LAWYERS	PROFESSIONAL SERVICES TO 25/11/2019 RE: CONTRACT REVIEW	1		820.05
INV 1048713	29/11/2019	HWL EBSWORTH LAWYERS	PROFESSIONAL SERVICES TO 25/11/2019 RE: CONTRACT REVIEW	1	820.05	

Ordinary Council Meeting Minutes
22 January 2020



Date: 07/01/2020
Time: 8:12:43AM

Shire of Northam

USER: Kathy Scholz
PAGE: 33

Cheque /EFT No	Date	Name	Invoice Description	Bank Code	INV Amount	Amount
EFT35183	12/12/2019	JACK LITTLE	RELOCATION EXPENSES AS PER EMPLOYMENT CONTRACT	1		1,237.80
INV RR04/11/06/12/2019		JACK LITTLE	RELOCATION EXPENSES AS PER EMPLOYMENT CONTRACT	1	1,237.80	
EFT35184	12/12/2019	JACK RONALD PARMENTER	REIMBURSMENT FOR POOL LIFEGUARD COURSE.	1		299.00
INV RR21112021/11/2019		JACK RONALD PARMENTER	REIMBURSMENT FOR POOL LIFEGUARD COURSE.	1	299.00	
EFT35185	12/12/2019	JOHN PROUD	TOWN WARD CANDIDATE NOMINATION 2019 SHIRE OF NORTHAM.	1		80.00
INV T1225	11/12/2019	JOHN PROUD	TOWN WARD CANDIDATE NOMINATION 2019 SHIRE OF NORTHAM.	1	80.00	
EFT35186	12/12/2019	JULIE ELLEN GREENFIELD WILLIAMS	CENTRAL WARD CANDIDATE NOMINATION 2019 SHIRE OF NORTHAM	1		80.00
INV T1223	11/12/2019	JULIE ELLEN GREENFIELD WILLIAMS	CENTRAL WARD CANDIDATE NOMINATION 2019 SHIRE OF NORTHAM	1	80.00	
EFT35187	12/12/2019	LIGHTING OPTIONS AUSTRALIA PTY LTD	BKB CENTRE SUPPLY AND DELIVER REFLECTOR WITH GLASS AS PER EMAIL #3000044561	1		497.38
INV INV-239328/11/2019		LIGHTING OPTIONS AUSTRALIA PTY LTD	BKB CENTRE SUPPLY AND DELIVER REFLECTOR WITH GLASS AS PER EMAIL #3000044561	1	497.38	
EFT35188	12/12/2019	IUME BRASSERIE	CATERING - COUNCIL FORUM MEETING 13 NOVEMBER 2019	1		350.00
INV 1311201913/11/2019		IUME BRASSERIE	CATERING - COUNCIL FORUM MEETING 13 NOVEMBER 2019	1	350.00	
EFT35189	12/12/2019	MAREN MAY LAVERY	TOWN WARD CANDIDATE NOMINATION 2019 SHIRE OF NORTHAM.	1		80.00
INV T1215	11/12/2019	MAREN MAY LAVERY	TOWN WARD CANDIDATE NOMINATION 2019 SHIRE OF NORTHAM.	1	80.00	
EFT35190	12/12/2019	MARIA IRENE GIRAK	TOWN WARD NOMINATION 2019 SHIRE OF NORTHAM	1		80.00
INV T1219	11/12/2019	MARIA IRENE GIRAK	TOWN WARD NOMINATION 2019 SHIRE OF NORTHAM	1	80.00	
EFT35191	12/12/2019	MCLEODS BARRISTERS & SOLICITORS	LEGAL COSTS ASSOCIATED WITH 4 HOVEA CRESCENT, WUNDOWIE	1		934.00

Ordinary Council Meeting Minutes
22 January 2020



Date: 07/01/2020
Time: 8:12:43AM

Shire of Northam

USER: Kathy Scholz
PAGE: 34

Cheque /EFT No	Date	Name	Invoice Description	Bank Code	INV Amount	Amount
INV 111414	29/11/2019	MCLEODS BARRISTERS & SOLICITORS	LEGAL COSTS ASSOCIATED WITH 4 HOVEA CRESCENT, WUNDOWIE	1	934.00	
EFT35192	12/12/2019	MHW INTEGRATION PTY LTD	CONTRACT NO 4 OF NAEIC PROJECT RETENTION CLAIM 2.	1		4,072.05
INV T1109	11/12/2019	MHW INTEGRATION PTY LTD	CONTRACT NO 4 OF NAEIC PROJECT RETENTION CLAIM 2.	1	4,072.05	
EFT35193	12/12/2019	MULTICON COMMERCIAL CONSTRUCTIONS	INFRASTRUCTURE/KERB BOND REFUND FOR BLDG PERMIT NO.13250#.	1		1,534.04
INV T707	11/12/2019	MULTICON COMMERCIAL CONSTRUCTIONS	INFRASTRUCTURE/KERB BOND REFUND FOR BLDG PERMIT NO.13250#.	1	1,534.04	
EFT35194	12/12/2019	NORTHAM BETTA ELECTRICAL	JBL GO 2 MINI SPEAKER	1		49.00
INV 2001000702/12/2019	12/12/2019	NORTHAM BETTA ELECTRICAL	JBL GO 2 MINI SPEAKER	1	49.00	
EFT35195	12/12/2019	NORTHAM COUNTRY CLUB INC	SENIOR SPORT FUNDING	1		200.00
INV 2911	27/11/2019	NORTHAM COUNTRY CLUB INC	SENIOR SPORT FUNDING	1	100.00	
INV 2912	27/11/2019	NORTHAM COUNTRY CLUB INC	SENIOR SPORT FUNDING	1	100.00	
EFT35196	12/12/2019	NORTHAM PRIMARY SCHOOL	2019 END OF YEAR BOOK AWARDS	1		200.00
INV 4475	29/11/2019	NORTHAM PRIMARY SCHOOL	2019 END OF YEAR BOOK AWARDS	1	200.00	
EFT35197	12/12/2019	OXTER SERVICES	PRODUCTS USED IN PUBLIC TOILET CLEANING FROM 11/11/2019 TO 22/11/2019	1		241.82
INV 22061	22/11/2019	OXTER SERVICES	PRODUCTS USED IN PUBLIC TOILET CLEANING FROM 11/11/2019 TO 22/11/2019	1	121.35	
INV 22065	22/11/2019	OXTER SERVICES	ADMIN BUILDING. SUPPLY 2 X BOXES ULTRA SLIM HAND TOWELS AND 1 X ROLL WIPES.	1	120.47	
EFT35198	12/12/2019	PFD FOOD SERVICES PTY LTD	STOCK PURCHASES FOR SWIMMING POOL.	1		972.65
INV KR8052615/11/2019	11/2019	PFD FOOD SERVICES PTY LTD	STOCK PURCHASES FOR SWIMMING POOL.	1	972.65	
EFT35199	12/12/2019	POWER DESMOND JOHN	BAKERS HILL PAVILION. PAINT EAVES TO FRONT OF PAVILION, AS PER QUOTE.	1		808.50

Ordinary Council Meeting Minutes
22 January 2020

Date: 07/01/2020
Time: 8:12:43AM

Shire of Northam

USER: Kathy Scholz
PAGE: 35

Cheque /EFT No	Date	Name	Invoice Description	Bank Code	INV Amount	Amount
INV 55923	16/11/2019	POWER DESMOND JOHN	BAKERS HILL PAVILION. PAINT EAVES TO FRONT OF PAVILION, AS PER QUOTE.	1	808.50	
EFT35200	12/12/2019	PUBLIC TRANSPORT AUTHORITY	TRAIN TICKET SALES 2019/20	1		298.20
INV OCTOBE31/10/2019		PUBLIC TRANSPORT AUTHORITY	TRAIN TICKET SALES 2019/20	1	298.20	
EFT35201	12/12/2019	QUBE LOGISTICS	DELIVERY OF 920KG DRUM OF CHLORINE DELIVERED TO WASTE WATER TREATMENT PLANT (CLARK STREET) - CORRESPONDING IXOM PURCHASE ORDER 53457	1		837.31
INV TS1759822/11/2019		QUBE LOGISTICS	DELIVERY OF 920KG DRUM OF CHLORINE DELIVERED TO WASTE WATER TREATMENT PLANT (CLARK STREET) - CORRESPONDING IXOM PURCHASE ORDER 53457	1	837.31	
EFT35202	12/12/2019	RIVERGUM VALLEY LAVENDER	STOCK PURCHASES FOR VISITORS CENTRE	1		290.50
INV 0000031229/11/2019		RIVERGUM VALLEY LAVENDER	STOCK PURCHASES FOR VISITORS CENTRE	1	290.50	
EFT35203	12/12/2019	ROBERT WAYNE TINETTI	TOWN WARD NOMINATION 2019 SHIRE OF NORTHAM.	1		80.00
INV T1220	11/12/2019	ROBERT WAYNE TINETTI	TOWN WARD NOMINATION 2019 SHIRE OF NORTHAM.	1	80.00	
EFT35204	12/12/2019	RWE ROBINSON & SONS PTY LTD	INFRASTRUCTURE BOND REFUND FOR BLDG PERMIT NO.12045 R#60082.	1		1,534.04
INV T630	11/12/2019	RWE ROBINSON & SONS PTY LTD	INFRASTRUCTURE BOND REFUND FOR BLDG PERMIT NO.12045 R#60082.	1	1,534.04	
EFT35205	12/12/2019	SPECIALE SMASH REPAIRS	REPLACE/ PAINT FRONT BUMPER TOP MOULD AS PER QUOTE 16656 PN1702 - REGO N11131	1		526.35
INV 18689/1	20/11/2019	SPECIALE SMASH REPAIRS	REPLACE/ PAINT FRONT BUMPER TOP MOULD AS PER QUOTE 16656 PN1702 - REGO N11131	1	526.35	
EFT35206	12/12/2019	SPECIALISED TREE SERVICE	ANNUAL TOWNSITE PRUNING WUNDOWIE AS PER C.201819-09 - SCHEDULE OF RATES	1		7,955.06
INV 3199	09/12/2019	SPECIALISED TREE SERVICE	ANNUAL TOWNSITE PRUNING WUNDOWIE AS PER C.201819-09 - SCHEDULE OF RATES	1	7,955.06	
EFT35207	12/12/2019	ST JOHN AMBULANCE AUSTRALIA (WA) INC.	FIRST AID KITS- X 2 (OCT 19 & JAN 2020) WUNDOWIE POOL	1		2,085.66

Ordinary Council Meeting Minutes
22 January 2020



Date: 07/01/2020
Time: 8:12:43AM

Shire of Northam

USER: Kathy Scholz
PAGE: 36

Cheque /EFT No	Date	Name	Invoice Description	Bank Code	INV Amount	Amount
INV CYINV0010/09/2019		ST JOHN AMBULANCE AUSTRALIA (WA) INC.	FIRST AID KITS, GRAB BAG & DEFIBRILLATOR PADS IF REQUIRED - X 4 (SEPT 19, DEC 19, MAR 20, JUNE 2020) REC CENTRE	1	268.11	
INV CYINV0010/09/2019		ST JOHN AMBULANCE AUSTRALIA (WA) INC.	FIRST AID KITS, GRAB BAG & DEFIBRILLATOR PADS IF REQUIRED - X 1 (SEPT 19) CREATE 298	1	86.83	
INV CYINV0010/09/2019		ST JOHN AMBULANCE AUSTRALIA (WA) INC.	FIRST AID KITS, GRAB BAG & DEFIBRILLATOR PADS IF REQUIRED - X 2 (SEPT 2019, MAR 2020)	1	82.60	
INV CYINV0011/09/2019		ST JOHN AMBULANCE AUSTRALIA (WA) INC.	NORTHAM LIBRARY FIRST AID KITS, GRAB BAG & DEFIBRILLATOR PADS IF REQUIRED - X 4 (SEPT 19, DEC 19, MAR 20, JUNE 2020)	1	407.05	
INV CYINV0011/09/2019		ST JOHN AMBULANCE AUSTRALIA (WA) INC.	KILLARA FIRST AID KITS, GRAB BAG & DEFIBRILLATOR PADS IF REQUIRED - X 2 (SEPT 2019, MAR 2020)	1	218.15	
INV CYINV0012/09/2019		ST JOHN AMBULANCE AUSTRALIA (WA) INC.	VISITORS CENTRE FIRST AID KITS, GRAB BAG & DEFIBRILLATOR PADS IF REQUIRED - X 2 (SEPT 2019, MAR 2020)	1	89.65	
INV CYINV0018/09/2019		ST JOHN AMBULANCE AUSTRALIA (WA) INC.	WUNDOWIE LIBRARY FIRST AID KITS, GRAB BAG & DEFIBRILLATOR PADS IF REQUIRED - X 2 (SEPT 2019, MAR 2020)	1	155.81	
INV CYINV0017/10/2019		ST JOHN AMBULANCE AUSTRALIA (WA) INC.	WUNDOWIE DEPOT FIRST AID KITS- X 2 (OCT 19 & JAN 2020) WUNDOWIE POOL	1	637.46	
INV CINV00020/11/2019		ST JOHN AMBULANCE AUSTRALIA (WA) INC.	NORTHAM CENTRAL 2.4 - HARD, MEDIUM FIRST AID KIT	1	140.00	
EFT35208	12/12/2019	ST JOSEPH'S SCHOOL	CONTRIBUTION TWARDS INDIGENOUS SCHOLARSHIP	1		770.00
INV 0312201903/12/2019		ST JOSEPH'S SCHOOL	CONTRIBUTION TOWARDS PRESENTATION NIGHT 2019	1	220.00	
INV 0312201903/12/2019		ST JOSEPH'S SCHOOL	CONTRIBUTION TWARDS INDIGENOUS SCHOLARSHIP	1	550.00	
EFT35209	12/12/2019	TOTAL INSTALL SOLUTIONS AUST PTY LTD	SUPPLY & INSTALL 2 CEL-FI UNITS IN 2 VEHICLES	1		5,964.19
INV 1303_1&27/11/2019		TOTAL INSTALL SOLUTIONS AUST PTY LTD	SUPPLY & INSTALL 2 CEL-FI UNITS IN 2 VEHICLES	1	5,964.19	
EFT35210	12/12/2019	TUTT BRYANT EQUIPMENT PTY LTD	EXPANSION TANK FOR BOMAG TYRE ROLLER FOR PN1502 - REGO N4174 PART# 05903297 AS PER QUOTE	1		847.56

Ordinary Council Meeting Minutes
22 January 2020

Date: 07/01/2020
Time: 8:12:43AM

Shire of Northam

USER: Kathy Scholz
PAGE: 37

Cheque /EFT No	Date	Name	Invoice Description	Bank Code	INV Amount	Amount
INV 0084583811/11/2019		TUTT BRYANT EQUIPMENT PTY LTD	ARM WIPER 05571542	1	226.66	
INV 0084584414/11/2019		TUTT BRYANT EQUIPMENT PTY LTD	EXPANSION TANK FOR BOMAG TYRE ROLLER FOR PN1502 - REGO N4174 PART# 05903297 AS PER QUOTE	1	620.90	
EFT35211	12/12/2019	TYRECYCLE PTY LTD	COLLECTION AND RECYCLING OF WASTE TYRES FROM THE INKPEN LAND FILL SITE.	1		3,114.74
INV 817243	15/11/2019	TYRECYCLE PTY LTD	COLLECTION AND RECYCLING OF WASTE TYRES FROM THE INKPEN LAND FILL SITE.	1	3,114.74	
EFT35212	12/12/2019	TYREPOWER	CONTINENTAL 225/55R18 98H FR. ULTRA CONTRACT UC6 SUV PLUS FITTING AND BALANCE FOR REGO N9467 (PN1621)	1		558.69
INV 8265.13029/10/2019		TYREPOWER	CONTINENTAL 225/55R18 98H FR. ULTRA CONTRACT UC6 SUV PLUS FITTING AND BALANCE FOR REGO N9467 (PN1621)	1	558.69	
EFT35213	12/12/2019	VERNICE PTY LTD	RELOCATE 4000M3 OF DIRT FROM STOCK PILE AT REAR OF OLD QUARRY LANDFILL SITE AND DEPOSIT AT TIP FACE AREA.	1		17,600.00
INV 8256	12/11/2019	VERNICE PTY LTD	OLD QUARRY ROAD FIRE BREAKS AS PER MAP GIVEN AT REQUEST. FIRE BREAK TO BE COMPLETED BY 31.10.2019.	1	2,640.00	
INV 8276	03/12/2019	VERNICE PTY LTD	RELOCATE 4000M3 OF DIRT FROM STOCK PILE AT REAR OF OLD QUARRY LANDFILL SITE AND DEPOSIT AT TIP FACE AREA.	1	14,960.00	
EFT35214	12/12/2019	VINCELEC	REPLACE GLOBE IN CHEMICAL CUPBOARD.	1		318.52
INV 1269	25/11/2019	VINCELEC	REPLACE CRACKED GPO COVER IN COTTAGE KITCHEN REPLACE GLOBE IN CHEMICAL CUPBOARD. REPLACE CRACKED GPO COVER IN COTTAGE KITCHEN	1	318.52	
EFT35215	12/12/2019	WBS GROUP PTY LTD	SES SHED NORTHAM. SUPPLY AND INSTALL 4 X ROLLER DOORS AS PER SITE VISIT AND QUOTE REF:6710/1.	1		2,970.00
INV 101513	27/11/2019	WBS GROUP PTY LTD	SES SHED NORTHAM. SUPPLY AND INSTALL 4 X ROLLER DOORS AS PER SITE VISIT AND QUOTE REF:6710/1.	1	2,970.00	
EFT35216	12/12/2019	WEST NORTHAM PRIMARY SCHOOL	EOY AWARDS DONATION	1		200.00
INV 1023	02/12/2019	WEST NORTHAM PRIMARY SCHOOL	EOY AWARDS DONATION	1	200.00	

Ordinary Council Meeting Minutes
22 January 2020



Date: 07/01/2020
Time: 8:12:43AM

Shire of Northam

USER: Kathy Scholz
PAGE: 38

Cheque /EFT No	Date	Name	Invoice Description	Bank Code	INV Amount	Amount
EFT35217	12/12/2019	WESTERN AUSTRALIAN LOCAL GOVERNMENT ASSOCIATION	EFFECTIVE LETTER & REPORT WRITING IN LOCAL GOVERNMENT 24/09/2019	1		8,871.00
INV B078947	23/09/2019	WESTERN AUSTRALIAN LOCAL GOVERNMENT ASSOCIATION	LOCAL GOVERNMENT PEOPLE AND CULTURE SEMINAR 11/10/2019 HELEN ZAHRA	1	300.00	
INV B078948	23/09/2019	WESTERN AUSTRALIAN LOCAL GOVERNMENT ASSOCIATION	LOCAL GOVERNMENT PEOPLE AND CULTURE SEMINAR 11/10/2019 BEV JONES	1	300.00	
INV B078963	24/09/2019	WESTERN AUSTRALIAN LOCAL GOVERNMENT ASSOCIATION	EFFECTIVE LETTER & REPORT WRITING IN LOCAL GOVERNMENT 24/09/2019	1	4,345.00	
INV B079758	31/10/2019	WESTERN AUSTRALIAN LOCAL GOVERNMENT ASSOCIATION	STAFF TRAINING FOR SHANE MOORHEAD. CONTRACT MANAGEMENT ON 05/11/2019	1	688.00	
INV B079759	31/10/2019	WESTERN AUSTRALIAN LOCAL GOVERNMENT ASSOCIATION	STAFF TRAINING FOR SHANE MOORHEAD. EVALUATION, SUPPLIER SELECTION AND CONTRACTOR MANAGEMENT 04/11/2019.	1	688.00	
INV B079790	05/11/2019	WESTERN AUSTRALIAN LOCAL GOVERNMENT ASSOCIATION	PUBLIC NOTICES MODULE FOR SHIRE OF NORTHAM WEBSITE	1	600.00	
INV B079860	08/11/2019	WESTERN AUSTRALIAN LOCAL GOVERNMENT ASSOCIATION	E-LEARNING - UNDERSTANDING LOCAL GOVERNMENT - DAVID GALLOWAY	1	390.00	
INV B079861	08/11/2019	WESTERN AUSTRALIAN LOCAL GOVERNMENT ASSOCIATION	E-LEARNING - UNDERSTANDING LOCAL GOVERNMENT MARIA GIRAK	1	390.00	
INV B079862	08/11/2019	WESTERN AUSTRALIAN LOCAL GOVERNMENT ASSOCIATION	E-LEARNING - UNDERSTANDING LOCAL GOVERNMENT - CHRIS ANTONIO	1	390.00	
INV B079863	08/11/2019	WESTERN AUSTRALIAN LOCAL GOVERNMENT ASSOCIATION	E-LEARNING - UNDERSTANDING LOCAL GOVERNMENT - JULIE WILLIAMS	1	390.00	
INV B079864	08/11/2019	WESTERN AUSTRALIAN LOCAL GOVERNMENT ASSOCIATION	E-LEARNING - UNDERSTANDING LOCAL GOVERNMENT - ROB TINETTI	1	390.00	
EFT35218	12/12/2019	WESTWATER ENTERPRISES PTY LTD	24VDC SOUNDER BEACON ESS0045LRR	1		920.48
INV WS0632	12/11/2019	WESTWATER ENTERPRISES PTY LTD	AS PER QUOTE# SWA-0430 CELL GENERATOR	1	66.00	
INV WS0630	12/11/2019	WESTWATER ENTERPRISES PTY LTD	24VDC SOUNDER BEACON ESS0045LRR	1	854.48	
EFT35219	12/12/2019	WRIGHT EXPRESS AUSTRALIA PTY LTD (PUMA ENERGY)	FUEL PURCHASES AT PUMA - NOVEMBER 2019.	1		1,306.35
INV 60	30/11/2019	WRIGHT EXPRESS AUSTRALIA PTY LTD (PUMA ENERGY)	FUEL PURCHASES AT PUMA - NOVEMBER 2019.	1	1,306.35	

Ordinary Council Meeting Minutes
22 January 2020



Date: 07/01/2020
Time: 8:12:43AM

Shire of Northam

USER: Kathy Scholz
PAGE: 39

Cheque /EFT No	Date	Name	Invoice Description	Bank Code	INV Amount	Amount
EFT35220	13/12/2019	SAMPSON ELECTRICAL CONTRACTORS PTY LTD	ACCESS POWER POINTS BEHIND CABINETS AND RELOCATE TO SUITABLE LOCATION THREE IN TOTAL HAD TO WAIT FOR CABINET MAKER AND POSTER PEOPLE TO REMOVE EQUIPMENT TO ACCESS THE AREA.	1		968.00
INV 0000214631/08/2018		SAMPSON ELECTRICAL CONTRACTORS PTY LTD	ACCESS POWER POINTS BEHIND CABINETS AND RELOCATE TO SUITABLE LOCATION THREE IN TOTAL HAD TO WAIT FOR CABINET MAKER AND POSTER PEOPLE TO REMOVE EQUIPMENT TO ACCESS THE AREA.	1	968.00	
EFT35221	17/12/2019	COOPER & OXLEY CONSTRUCTION CO PTY LTD	CONSTRUCTION OF NEW NORTHAM AQUATIC FACILITY AS PER CONTRACT 2018-2 ESSENTIAL ELEMENTS.	1		994,080.87
INV 3507	16/12/2019	COOPER & OXLEY CONSTRUCTION CO PTY LTD	CONSTRUCTION OF NEW NORTHAM AQUATIC FACILITY AS PER CONTRACT 2018-2 ESSENTIAL ELEMENTS.	1	994,080.87	
EFT35222	17/12/2019	AMPAC DEBT RECOVERY (WA) P/L	DEBT RECOVERY FOR NOVEMBER 2019	1		3,414.73
INV 61099	14/11/2019	AMPAC DEBT RECOVERY (WA) P/L	DEBT RECOVERY FOR NOVEMBER 2019	1	732.51	
INV 61151	21/11/2019	AMPAC DEBT RECOVERY (WA) P/L	DEBT RECOVERY COST FOR OCTOBER 2019	1	323.82	
INV 61191	28/11/2019	AMPAC DEBT RECOVERY (WA) P/L	DEBT RECOVERY FOR NOVEMBER 2019	1	257.40	
INV 61353	30/11/2019	AMPAC DEBT RECOVERY (WA) P/L	DEBT RECOVERY FOR NOVEMBER 2019	1	2,046.00	
INV 61354	30/11/2019	AMPAC DEBT RECOVERY (WA) P/L	DEBT RECOVERY FOR NOVEMBER 2019	1	55.00	
EFT35223	17/12/2019	AUSTRALIAN SERVICES UNION	Payroll deductions	1		257.00
INV DEDUCT10/12/2019		AUSTRALIAN SERVICES UNION	Payroll deductions		257.00	
EFT35225	17/12/2019	AUTOPRO NORTHAM	CAR CLEANING KIT	1		164.43
INV 812583	13/11/2019	AUTOPRO NORTHAM	STEERING WHEEL COVER FOR PN1511	1	25.32	
INV 812728	13/11/2019	AUTOPRO NORTHAM	MULTIMETER	1	15.01	
INV 812891	14/11/2019	AUTOPRO NORTHAM	WIPER BLADE FRAME PART#TBS60	1	19.59	
INV 812853	14/11/2019	AUTOPRO NORTHAM	STEERING WHEEL COVER FOR PN1511	1	-25.32	
INV 812858	14/11/2019	AUTOPRO NORTHAM	Steering wheel cover for PN1511	1	23.24	

Ordinary Council Meeting Minutes
22 January 2020

Date: 07/01/2020
Time: 8:12:43AM

Shire of Northam

USER: Kathy Scholz
PAGE: 40

Cheque /EFT No	Date	Name	Invoice Description	Bank Code	INV Amount	Amount
INV 813510	18/11/2019	AUTOPRO NORTHAM	SOLDERING KIT + ELECTRICAL TAPE	1	22.37	
INV 813785	20/11/2019	AUTOPRO NORTHAM	CAR CLEANING KIT	1	64.38	
INV 813965	21/11/2019	AUTOPRO NORTHAM	TYRE INFLATOR/GAUGE	1	19.84	
EFT35226	17/12/2019	AVON SERVICE SPECIALISTS	50,000KM SERVICE ON PN1710 - REGO N79 PLEASE ADJUST HEADLIGHTS SLIGHTLY DOWN	1		306.30
INV 17837	29/11/2019	AVON SERVICE SPECIALISTS	50,000KM SERVICE ON PN1710 - REGO N79 PLEASE ADJUST HEADLIGHTS SLIGHTLY DOWN	1	306.30	
EFT35227	17/12/2019	BELINGARNI FABRICATION HOME AND PROPERTY SERVICES	CARRY OUT VERGE MAINTENANCE IN THE KOOJEEDA HILLS AREA: JOSE ROAD, ALMOND AVE, TAMARILLO COURT, GREENGLADE PLACE AND VALENCIA GLADE	1		2,750.00
INV 581	13/11/2019	BELINGARNI FABRICATION HOME AND PROPERTY SERVICES	CARRY OUT VERGE MAINTENANCE IN THE KOOJEEDA HILLS AREA: JOSE ROAD, ALMOND AVE, TAMARILLO COURT, GREENGLADE PLACE AND VALENCIA GLADE	1	2,750.00	
EFT35228	17/12/2019	CENTRAL MOBILE MECHANICAL REPAIRS	ANNUAL HEAVY SERVICE OF BAKERS HILL 2.4 ISUZU AS PER ATTACHED CHECK LIST AND CONTRACT C.201920-02.1	1		13,223.76
INV 0000296906/12/2019		CENTRAL MOBILE MECHANICAL REPAIRS	ANNUAL HEAVY SERVICE OF BAKERS HILL 2.4 ISUZU AS PER ATTACHED CHECK LIST AND CONTRACT C.201920-02.1	1	11,878.46	
INV 0000297609/12/2019		CENTRAL MOBILE MECHANICAL REPAIRS	BAKERS HILL 2.4 - ATTEND BAKERS HILL FIRE SHED TO DIAGNOSE AND REPORT ON FRONT AXLE FAULT.	1	453.20	
INV 0000297809/12/2019		CENTRAL MOBILE MECHANICAL REPAIRS	INKPEN LT, LANDCRUISER, IGBO744 - REPAIR FUEL LINE ON THE AUXILIARY PUMP	1	892.10	
EFT35229	17/12/2019	COMBINED TYRES	255/70R BRIDGESTONE M857 - CENTRAL 2.4 REGO 1BMR-019	1		21,250.70
INV INV-329708/11/2019		COMBINED TYRES	CALLOUT FEE TO REFIT NEW TYRE TO CLACKLINE LT1 REGO 1DJA-799	1	165.00	
INV INV-335213/11/2019		COMBINED TYRES	IRISHTOWN 1.4 ISUZU TRUCK REGO N.2501 REPLACE STEER TYRES 235/75R17.5 BRIDGESTONE R156	1	3,018.40	
INV INV-339315/11/2019		COMBINED TYRES	255/70R BRIDGESTONE M857 - CENTRAL 2.4 REGO 1BMR-019	1	3,692.70	

Ordinary Council Meeting Minutes
22 January 2020

Date: 07/01/2020
Time: 8:12:43AM

Shire of Northam

USER: Kathy Scholz
PAGE: 41

Cheque /EFT No	Date	Name	Invoice Description	Bank Code	INV Amount	Amount
INV INV-340019/11/2019		COMBINED TYRES	SUPPLY 9R22.5 BRIDGESTONE STEER TYRES TO FRONT OF TRUCK ENCLUDING FITTING AT CMMR WORKSHOP REGO 1BNP-584	1	2,383.70	
INV INV-344120/11/2019		COMBINED TYRES	SITE CALL OUT TO REPAIR FLAT TYRE ON MULTI TYRE ROLLER PN1502 LOCATED ON COLGONGINE ROAD INKPEN. 18/11/2019 1330-1600HRS	1	2,706.00	
INV INV-347426/11/2019		COMBINED TYRES	BALANCE STEER TYRES ON ISUZU WUNDOWIE PN1509 - REGO N11142	1	88.00	
INV INV-350128/11/2019		COMBINED TYRES	RETIPLY TRAILER ISSUES (STOP CHEWING TYRES OUT) PN1413 - REGO N.002	1	2,514.40	
INV INV-351329/11/2019		COMBINED TYRES	REPLACE DRIVE TYRES ON 6 WHEEL TIPPER CENTRE AXLE 11R22.5 PN1611 - REGO N.007	1	1,562.00	
INV INV-356830/11/2019		COMBINED TYRES	SUPPLY AND FIT TWO REAR TYRES TO SEWELL ROAD BROOM TB200E PN1603 - REGO TRB-674 - 205/75R16 BALANCE AND TYRE DISPOSAL	1	446.60	
INV INV-357403/12/2019		COMBINED TYRES	SPARE RIM FOR MULTI TYRE ROLLER.	1	1,895.30	
INV INV-357704/12/2019		COMBINED TYRES	REPLACE FRONT AND REAR TYRES ON ISUZU TRUCK PN1305 - REGO N.4096	1	1,623.60	
INV INV-364109/12/2019		COMBINED TYRES	REPLACE FRONT STEER TYRES 215/75R17.5 / PLUS BALANCE AND TYRE DISPOSAL PN0913	1	869.00	
INV INV-364009/12/2019		COMBINED TYRES	REPLACE SPARE BALD TYRE ON PN1214 - REGO 1TNU484 /BALANCE/TYRE DISPOSAL	1	286.00	
EFT35230	17/12/2019	CORE BUSINESS AUSTRALIA	CONSULTANCY SERVICES FOR THE COMPLETE PROJECT MANAGEMENT FOR THE REINSTATEMENT REPAIRS TO FLOOD DAMAGED INFRASTRUCTURE ON VARIOUS ROADS AGRN 822 - WITHIN THE SHIRE OF NORTHAM.	1		22,322.87
INV INV-097830/11/2019		CORE BUSINESS AUSTRALIA	CONSULTANCY SERVICES FOR THE COMPLETE PROJECT MANAGEMENT FOR THE REINSTATEMENT REPAIRS TO FLOOD DAMAGED INFRASTRUCTURE ON VARIOUS ROADS AGRN 822 - WITHIN THE SHIRE OF NORTHAM.	1	22,322.87	
EFT35231	17/12/2019	COUNTRY COPIERS NORTHAM	COLOUR COPIER SERVIC/METER READING AT REC CENTRE	1		1,491.74
INV S8049	28/11/2019	COUNTRY COPIERS NORTHAM	COLOUR COPIER SERVIC/METER READING AT REC CENTRE	1	1,491.74	

Ordinary Council Meeting Minutes
22 January 2020



Date: 07/01/2020
Time: 8:12:43AM

Shire of Northam

USER: Kathy Scholz
PAGE: 42

Cheque /EFT No	Date	Name	Invoice Description	Bank Code	INV Amount	Amount
EFT35232	17/12/2019	COVS PARTS PTY LTD	PRESSURISED SPRAY CLEANER.	1		42.20
INV 1690067105/12/2019		COVS PARTS PTY LTD	PRESSURISED SPRAY CLEANER.	1	42.20	
EFT35233	17/12/2019	CTI SECURITY SERVICES PTY LTD	SECURITY MONITORING FROM 01/12/2019-31/12/2019	1		762.29
INV CINS307414/11/2019		CTI SECURITY SERVICES PTY LTD	SECURITY MONITORING FROM 01/12/2019-31/12/2019	1	53.00	
INV CINS307414/11/2019		CTI SECURITY SERVICES PTY LTD	SECURITY MONITORING FROM 01/12/2019-31/12/2019	1	53.00	
INV CINS307414/11/2019		CTI SECURITY SERVICES PTY LTD	SECURITY MONITORING FROM 01/12/2019-31/12/2019	1	61.96	
INV CINS307414/11/2019		CTI SECURITY SERVICES PTY LTD	SECURITY MONITORING FROM 01/12/2019-31/12/2019	1	90.56	
INV CIN3074914/11/2019		CTI SECURITY SERVICES PTY LTD	SECURITY MONITORING FROM 01/12/2019-31/12/2019	1	53.00	
INV CIN3074914/11/2019		CTI SECURITY SERVICES PTY LTD	SECURITY MONITORING FROM 01/12/2019-31/12/2019	1	87.96	
INV CINS307414/11/2019		CTI SECURITY SERVICES PTY LTD	SECURITY MONITORING FROM 01/12/2019-31/12/2019	1	61.96	
INV CINS307414/11/2019		CTI SECURITY SERVICES PTY LTD	SECURITY MONITORING FROM 01/12/2019-31/12/2019	1	61.96	
INV CINS307414/11/2019		CTI SECURITY SERVICES PTY LTD	SECURITY MONITORING FROM 01/12/2019-31/12/2019	1	61.97	
INV CINS307414/11/2019		CTI SECURITY SERVICES PTY LTD	SECURITY MONITORING FROM 01/12/2019-31/12/2019	1	61.96	
INV CINS307414/11/2019		CTI SECURITY SERVICES PTY LTD	SECURITY MONITORING FROM 01/12/2019-31/12/2019	1	61.96	
INV CINS307412/12/2019		CTI SECURITY SERVICES PTY LTD	SECURITY MONITORING FROM 01/12/2019-31/12/2019	1	53.00	
EFT35234	17/12/2019	DEPARTMENT FOR CHILD PROTECTION	INCORRECT CHARGE FOR HALF SEASON PASS - CHILD POOL PASS #S035	1		28.00
INV 130043	16/12/2019	DEPARTMENT FOR CHILD PROTECTION	INCORRECT CHARGE FOR HALF SEASON PASS - CHILD POOL PASS #S035	1	28.00	
EFT35235	17/12/2019	DMC CLEANING	CLEANING OF VARIOUS BUILDINGS.	1		4,490.57
INV SON027	25/11/2019	DMC CLEANING	CLEANING OF VARIOUS BUILDINGS.	1	4,490.57	
EFT35236	17/12/2019	EASIFLEET	Payroll deductions	1		3,036.10
INV DEDUCT10/12/2019		EASIFLEET	Payroll deductions		1,421.55	
INV DEDUCT10/12/2019		EASIFLEET	Payroll deductions		1,614.55	

Ordinary Council Meeting Minutes
22 January 2020

Date: 07/01/2020
Time: 8:12:43AM

Shire of Northam

USER: Kathy Scholz
PAGE: 43

Cheque /EFT No	Date	Name	Invoice Description	Bank Code	INV Amount	Amount
EFT35237	17/12/2019	FM SURVEYS	NORTHAM DEPOT REDEVELOPEMENT. SURVEY REAR BLOCK AS PER QUOTE.	1		7,040.00
INV 0002094820/11/2019		FM SURVEYS	NORTHAM DEPOT REDEVELOPEMENT. SURVEY REAR BLOCK AS PER QUOTE.	1	7,040.00	
EFT35238	17/12/2019	FRESH START RECOVERY PROGRAMME	CATERING - COUNCIL FORUM MEETING 11/12/2019	1		275.00
INV 0029175916/12/2019		FRESH START RECOVERY PROGRAMME	CATERING - COUNCIL FORUM MEETING 11/12/2019	1	275.00	
35239	06/12/2019	HELEN DANIELLA BINGHAM	REFUND FOR BRING OVERCHARGED FOR DOG REGO 0206513	1		15.00
INV 129068	31/10/2019	HELEN DANIELLA BINGHAM	REFUND FOR BRING OVERCHARGED FOR DOG REGO 0206513	1	15.00	
EFT35239	17/12/2019	FRONTLINE FIRE & RESCUE EQUIPMENT	CBFCO - BR9 HELMET, CAP STYLE WITH VISOR, NECK FLAP, HERCULITE TORCH AND PACIFIC TORCH HOLDER, RED WITH "NORTHAM CBFCO" REFLECTIVE ARCHES	1		1,219.81
INV 66064	27/11/2019	FRONTLINE FIRE & RESCUE EQUIPMENT	CBFCO - BR9 HELMET, CAP STYLE WITH VISOR, NECK FLAP, HERCULITE TORCH AND PACIFIC TORCH HOLDER, RED WITH "NORTHAM CBFCO" REFLECTIVE ARCHES	1	1,219.81	
EFT35240	17/12/2019	GLENN STUART BEVERIDGE	RAILWAY MUSEUM. INSTALL FLOOR JOISTS ALONG TERMITE DAMAGED JOISTS.	1		2,358.00
INV 36	05/12/2019	GLENN STUART BEVERIDGE	BAKERS HILL PAVILION. INSTALL PAPER TOWEL DISPENSERS X 2 LIKE FOR LIKE.	1	143.00	
INV 44	05/12/2019	GLENN STUART BEVERIDGE	REMOVE SHADE SAIL	1	400.00	
INV 39	05/12/2019	GLENN STUART BEVERIDGE	NORTHAM DEPOT. SUPPLY AND INSTALL DOOR CLOSER TO OFFICE ENTRY DOOR.	1	231.00	
INV 40	05/12/2019	GLENN STUART BEVERIDGE	VISITORS CENTRE. FIX DOOR HANDLE, SILICONE AROUND URINAL, CHANGE OUT FLURO LIGHT AND STARTER AND REPLACE DECKING BOARD.	1	286.00	
INV 41	05/12/2019	GLENN STUART BEVERIDGE	NORTHAM LIBRARY. PICK UP FROM BETTA ELECTRICAL AND INSTALL DISHWASHING MACHINE.	1	143.00	
INV 33	05/12/2019	GLENN STUART BEVERIDGE	RAILWAY MUSEUM. INSTALL FLOOR JOISTS ALONG TERMITE DAMAGED JOISTS.	1	484.00	
INV 37	05/12/2019	GLENN STUART BEVERIDGE	KILLARA COTTAGE. FIX LENS FOR PATH LIGHTING.	1	77.00	
INV 34	05/12/2019	GLENN STUART BEVERIDGE	BAKER HILL HOOPER PARK TOILET. SUPPLY AND INSTALL MALE AND FEMALE SIGNS.	1	99.00	

Ordinary Council Meeting Minutes
22 January 2020

Date: 07/01/2020
Time: 8:12:43AM

Shire of Northam

USER: Kathy Scholz
PAGE: 44

Cheque /EFT No	Date	Name	Invoice Description	Bank Code	INV Amount	Amount
INV 35	05/12/2019	GLENN STUART BEVERIDGE	WUNDOWIE PUBLIC TOILETS. SUPPLY AND INSTALL 1 X SOAP DISPENSER IN MALE AND FEMALE TOILETS.	1	99.00	
INV 45	06/12/2019	GLENN STUART BEVERIDGE	WUNDOWIE DEPOT. INSTALL NEW BENCHTOP TO KITCHEN AREA.	1	396.00	
35241	06/12/2019	NORTHAM COURTHOUSE	PAYMENT OF EXTRA ORDINARY LICENCE APPLICATION -ROBIN YARRIN.	1		200.00
INV CK0512205/12/2019	06/12/2019	NORTHAM COURTHOUSE	PAYMENT OF EXTRA ORDINARY LICENCE APPLICATION -ROBIN YARRIN.	1	200.00	
EFT35241	17/12/2019	GRAFTON ELECTRICS	ADMIN BUILDING. LABELLING OF SWITCHBOARDS AND POWER POINTS AS PER QUOTE.	1		3,103.10
INV 6439	15/11/2019	GRAFTON ELECTRICS	OLD TOWN ADMIN BUILDING. CHECK POWER FOR BREAST SCREEN VAN.	1	99.00	
INV 6442	19/11/2019	GRAFTON ELECTRICS	ADMIN BUILDING. LABELLING OF SWITCHBOARDS AND POWER POINTS AS PER QUOTE.	1	2,750.00	
INV 6452	20/11/2019	GRAFTON ELECTRICS	RAILWAY MUSEUM. REPLACE FAULTY POWER POINT IN ROOM 14.	1	99.00	
INV 6450	20/11/2019	GRAFTON ELECTRICS	TOWN HALL. REPLACE BLOWN GLOBES IN KITCHEN AREA.	1	155.10	
35242	06/12/2019	NORTHAM LOCAL DRUG ACTION GROUP	DRUG AND ALCOHOL WORKSHOP FACILITATION FOR NIGHT HOOPS PROGRAM.	1		220.00
INV 0000457	08/11/2019	NORTHAM LOCAL DRUG ACTION GROUP	DRUG AND ALCOHOL WORKSHOP FACILITATION FOR NIGHT HOOPS PROGRAM.	1	220.00	
EFT35242	17/12/2019	GREENACRES TURF GROUP	30M3 OF TURF	1		210.00
INV 0005702225/11/2019	17/12/2019	GREENACRES TURF GROUP	30M3 OF TURF	1	210.00	
35243	06/12/2019	PETTY CASH	PETTY CASH REIMBURSEMENT FOR ADMIN	1		412.10
INV P/C ADM04/12/2019	06/12/2019	PETTY CASH	PETTY CASH REIMBURSEMENT FOR ADMIN	1	412.10	
EFT35243	17/12/2019	HOUSE OF SHARDAY	STOCK PURCHASES FOR VISITORS CENTRE.	1		344.03
INV 0000082425/11/2019	17/12/2019	HOUSE OF SHARDAY	STOCK PURCHASES FOR VISITORS CENTRE.	1	344.03	
35244	06/12/2019	SHIRE OF BEVERLEY	SHIRE OF NORTHAM REIMBURSEMENT FOR CARAVAN & CAMPING SHOW ATTENDANCE FEES	1		386.65

Ordinary Council Meeting Minutes
22 January 2020



Date: 07/01/2020
Time: 8:12:43AM

Shire of Northam

USER: Kathy Scholz
PAGE: 45

Cheque /EFT No	Date	Name	Invoice Description	Bank Code	INV Amount	Amount
INV 5397	05/11/2019	SHIRE OF BEVERLEY	SHIRE OF NORTHAM REIMBURSEMENT FOR CARAVAN & CAMPING SHOW ATTENDANCE FEES	1	386.65	
EFT35244	17/12/2019	J & A.BUILDING PTY LTD	NORTHAM LIBRARY. UPGRADE EXISTING TOILETS AS PER SCOPE AND SPECIFICATIONS AS PER ACCEPTED QUOTE FOR RFQ 12 OF 2019 - NORTHAM LIBRARY ACCESSIBLE TOILET UPGRADE.	1		52,504.40
INV 0000261129/11/2019		J & A.BUILDING PTY LTD	NORTHAM LIBRARY. UPGRADE EXISTING TOILETS AS PER SCOPE AND SPECIFICATIONS AS PER ACCEPTED QUOTE FOR RFQ 12 OF 2019 - NORTHAM LIBRARY ACCESSIBLE TOILET UPGRADE.	1	50,210.90	
INV 0000262310/12/2019		J & A.BUILDING PTY LTD	NORTHAM LIBRARY ACCESSIBILITY TOILET UPGRADE. VARIATION # 1, EXTRA LABOUR AND SPECIALISED CORE DRILLER, DUE TO EXTRA THICK CONCRETE ON THE FLOOR. UP TO 300MM THICK. CONTRACT C-201920-04	1	2,293.50	
35245	06/12/2019	SHIRE OF NORTHAM	AROC ANNUAL MEMBEWRSHIP INV 026 JULY 2019- JUNE 2020 AS PER BUDGET ADOPTED	1		5,500.00
INV 026	27/09/2019	SHIRE OF NORTHAM	AROC ANNUAL MEMBEWRSHIP INV 026 JULY 2019- JUNE 2020 AS PER BUDGET ADOPTED	1	5,500.00	
EFT35245	17/12/2019	JS TECHNOLOGY & DIGITAL PTY LTD	PHONE RESET	1		38.00
INV 6375	25/11/2019	JS TECHNOLOGY & DIGITAL PTY LTD	PHONE RESET	1	38.00	
35246	06/12/2019	SYNERGY	STREET LIGHTS 03/10/2019-01/11/2019	1		39,708.48
INV 8110294724/10/2019		SYNERGY	WUNDOWIE POOL 26/08/2019-24/10/2019	1	2,896.64	
INV 1686149901/11/2019		SYNERGY	STREET LIGHTS 03/10/2019-01/11/2019	1	23,195.25	
INV 9152416401/11/2019		SYNERGY	AUXILLARY LIGHTING 02/10/2019-01/11/2019	1	133.29	
INV 7921766207/11/2019		SYNERGY	GROUPED ELECTRICITY 08/10/2019-07/11/2019	1	8,430.43	
INV 0929125212/11/2019		SYNERGY	GRASS VALLEY OVAL 12/09/2019-12/11/2019	1	111.18	
INV 9414532312/11/2019		SYNERGY	GRASS VALLEY FIRE SHED 12/09/2019-12/11/2019	1	274.00	
INV 5140678113/11/2019		SYNERGY	BERT HAWKE OVAL 13/09/2019-13/11/2019	1	283.08	

Ordinary Council Meeting Minutes
22 January 2020



Date: 07/01/2020
Time: 8:12:43AM

Shire of Northam

USER: Kathy Scholz
PAGE: 46

Cheque /EFT No	Date	Name	Invoice Description	Bank Code	INV Amount	Amount
INV 7471705313/11/2019		SYNERGY	SKATE PARK 13/09/2019-13/11/2019	1	145.48	
INV 2931107313/11/2019		SYNERGY	BKB 09/10/2019-13/11/2019	1	836.84	
INV 3358209420/11/2019		SYNERGY	CREATE 298 01/11/2019-20/11/2019	1	506.92	
INV 1819945021/11/2019		SYNERGY	KILLARA NEW BUILDINGS 17/10/2019-21/11/2019	1	906.71	
INV 1578225621/11/2019		SYNERGY	IRISHTOWN BFB 04/10/2019-21/11/2019	1	126.65	
INV 7968413421/11/2019		SYNERGY	SHIRE ADMIN BUILDING 17/10/2019-21/11/2019	1	1,862.01	
EFT35246	17/12/2019	JUICEBOX	TO BE INVOICED IN 4 PARTS (DECEMBER 2018, JULY 2019, AUGUST 2019, NOVEMBER 201) OUTPUTS (OPTION 1) 3X 60 SEC WEB VIDEOS SPECIFIC TO EACH PILLAR 3X 15 SEC WEB VIDEOS SPECIFIC TO EACH PILLAR (CUT DOWNS OF 60 SEC VIDEOS) EVENT COVERAGE FOR 3 EVENTS FOR PILLAR VIDEOS (SHORT LISTED TO CYCLING CRITERION EVENT, NORTHAM MOTORSPORT FESTIVAL, AND AVON RIVER FESTIVAL) 1X OVERARCHING VIDEO OF EVERYTHING	1		13,704.63
INV JBC-136712/12/2019		JUICEBOX	TO BE INVOICED IN 4 PARTS (DECEMBER 2018, JULY 2019, AUGUST 2019, NOVEMBER 201) OUTPUTS (OPTION 1) 3X 60 SEC WEB VIDEOS SPECIFIC TO EACH PILLAR 3X 15 SEC WEB VIDEOS SPECIFIC TO EACH PILLAR (CUT DOWNS OF 60 SEC VIDEOS) EVENT COVERAGE FOR 3 EVENTS FOR PILLAR VIDEOS (SHORT LISTED TO CYCLING CRITERION EVENT, NORTHAM MOTORSPORT FESTIVAL, AND AVON RIVER FESTIVAL) 1X OVERARCHING VIDEO OF EVERYTHING	1	13,704.63	
35248	06/12/2019	WATER CORPORATION	STANDPIPE AT NORTHAM DEPOT 12/09/2019-11/11/2019	1		24,149.50
INV 9007901104/11/2019		WATER CORPORATION	MORRELL ST PARK 03/09/2019-01/11/2019	1	496.03	
INV 9007945105/11/2019		WATER CORPORATION	KATRINE TOILETS 02/09/2019-04/11/2019	1	31.16	

Ordinary Council Meeting Minutes
22 January 2020



Date: 07/01/2020
Time: 8:12:43AM

Shire of Northam

USER: Kathy Scholz
PAGE: 47

Cheque /EFT No	Date	Name	Invoice Description	Bank Code	INV Amount	Amount
INV 9007901606/11/2019		WATER CORPORATION	RAILWAY MUSEUM 05/09/2019-05/11/2019	1	183.21	
INV 9007901706/11/2019		WATER CORPORATION	PURSLOWE PARK 06/09/2019-05/11/2019	1	862.20	
INV 9007899907/11/2019		WATER CORPORATION	GIRL GUIDIES HALL 06/09/2019-06/11/2019	1	76.23	
INV 9007903707/11/2019		WATER CORPORATION	TOWN & LESSER HALL 06/09/2019-06/11/2019	1	507.46	
INV 9012642708/11/2019		WATER CORPORATION	GARDEN AT NIND ST 10/09/2019-07/11/2019	1	12.99	
INV 9007909708/11/2019		WATER CORPORATION	JUBILEE OVAL 09/09/2019-07/11/2019	1	595.98	
INV 9007929408/11/2019		WATER CORPORATION	AVON MALL 10/09/2019-07/11/2019	1	738.17	
INV 9007907408/11/2019		WATER CORPORATION	BERNARD PARK PLAY CENTRE 10/09/2019-07/11/2019	1	189.85	
INV 9007906908/11/2019		WATER CORPORATION	OLD HEALTH CLINIC 10/09/2019-07/11/2019	1	63.91	
INV 9007904008/11/2019		WATER CORPORATION	MEMORIAL HALL 10/09/2019-07/11/2019	1	261.15	
INV 9007908108/11/2019		WATER CORPORATION	TRAFFICE ISLANDS 10/09/2019-07/11/2019	1	70.12	
INV 9007907308/11/2019		WATER CORPORATION	RESERVE AT AVON ST 10/09/2019-07/11/2019	1	1,093.34	
INV 9007903908/11/2019		WATER CORPORATION	BKB CENTRE 10/09/2019-07/11/2019	1	830.52	
INV 9007907408/11/2019		WATER CORPORATION	BERNARD PARK 10/09/2019-07/11/2019	1	2,535.38	
INV 9007908608/11/2019		WATER CORPORATION	KILLARA 09/09/2019-07/11/2019	1	1,705.79	
INV 9007904008/11/2019		WATER CORPORATION	NORTHAM LIBRARY 10/09/2019-07/11/2019	1	611.74	
INV 9008729808/11/2019		WATER CORPORATION	VISITORS CENTRE 10/09/2019-07/11/2019	1	892.13	
INV 9011070408/11/2019		WATER CORPORATION	RIVERSEDGE 01/11/2019-31/12/2019	1	215.54	
INV 9007913512/11/2019		WATER CORPORATION	NORTHAM DEPOT 12/09/2019-11/11/2019	1	476.52	
INV 9007913512/11/2019		WATER CORPORATION	STANDPIPE AT NORTHAM DEPOT 12/09/2019-11/11/2019	1	4,413.21	
INV 9007917013/11/2019		WATER CORPORATION	CEMETERY 13/09/2019-12/11/2019	1	1,826.81	
INV 9007916613/11/2019		WATER CORPORATION	MORTBY COTTAGE 13/09/2019-12/11/2019	1	47.71	
INV 9007923414/11/2019		WATER CORPORATION	APEX PARK TOILETS 17/09/2019-13/11/2019	1	104.15	
INV 9012475714/11/2019		WATER CORPORATION	GARDEN AT TAYLOR ST 13/09/2019-12/11/2019	1	88.30	

Ordinary Council Meeting Minutes
22 January 2020



Date: 07/01/2020
Time: 8:12:43AM

Shire of Northam

USER: Kathy Scholz
PAGE: 48

Cheque /EFT No	Date	Name	Invoice Description	Bank Code	INV Amount	Amount
INV 9007917218/11/2019		WATER CORPORATION	BURWOOD PARK FROM BASKETBALL COURTS 18/09/2019-15/11/2019	1	46.75	
INV 9007917218/11/2019		WATER CORPORATION	BERT HAWKE OVAL 18/09/2019-15/11/2019	1	826.45	
INV 9007923519/11/2019		WATER CORPORATION	TRAFFIC ISLAND 20/09/2019-18/11/2019	1	46.75	
INV 9007925919/11/2019		WATER CORPORATION	RESERVE NEWCASTLE RD 19/09/2019-18/11/2019	1	805.07	
INV 9012562919/11/2019		WATER CORPORATION	ROAD VERGE 20/09/2019-18/11/2019	1	88.30	
INV 9007918419/11/2019		WATER CORPORATION	PERINA WAY PARK 19/09/2019-18/11/2019	1	1,132.29	
INV 9021499419/11/2019		WATER CORPORATION	NORTHAM SWIMMING POOL 20/09/2019-18/11/2019	1	186.55	
INV 9007925920/11/2019		WATER CORPORATION	OLD QUARRY RD POUND 23/09/2019-19/11/2019	1	207.76	
INV 9007926020/11/2019		WATER CORPORATION	SPORTS GROUND COLEBATCH RD 23/09/2019-19/11/2019	1	57.13	
INV 9007927520/11/2019		WATER CORPORATION	OLD QUARRY RD REFUSE SITE 23/09/2019-19/11/2019	1	472.65	
INV 9023586921/11/2019		WATER CORPORATION	NEW POOL TRADE WASTE 26/09/2019-30/06/2020	1	825.61	
INV 9010596322/11/2019		WATER CORPORATION	GEORGE NUICH PARK 24/09/2019-21/11/2019	1	524.59	
EFT35248	17/12/2019	LANDGATE	RURAL UV'S CHARGEABLE SCHEDULE NO: R 2019/10 DATED 02/10/2019 TO 28/10/2019.	1		313.97
INV 352784-1027/11/2019		LANDGATE	RURAL UV'S CHARGEABLE SCHEDULE NO: R 2019/10 DATED 02/10/2019 TO 28/10/2019.	1	167.52	
INV 352833-1028/11/2019		LANDGATE	GROSS RENTAL VALUATION'S CHARGEABLE SCHEDULE NO: G 2019/11 DATED 21/09/2019 TO 18/10/2019.	1	67.85	
INV 971175	02/12/2019	LANDGATE	OTHER DLI INVOICES	1	78.60	
35249	12/12/2019	SHIRE OF NORTHAM	PAYMENT FOR COLLECTION OF BSL FEES ON BEHALF OF THE CONSTRUCTION TRAINING FUND FOR THE MONTH OF NOVEMBER 2019.	1		126.50
INV T1079	11/12/2019	SHIRE OF NORTHAM	PAYMENT FOR COLLECTION OF BCITF FEES ON BEHALF OF THE CONSTRUCTION TRAINING FUND FOR THE MONTH OF NOVEMBER 2019.	1	16.50	
INV T1080	11/12/2019	SHIRE OF NORTHAM	PAYMENT FOR COLLECTION OF BSL FEES ON BEHALF OF THE CONSTRUCTION TRAINING FUND FOR THE MONTH OF NOVEMBER 2019.	1	110.00	

Ordinary Council Meeting Minutes
22 January 2020



Date: 07/01/2020
Time: 8:12:43AM

Shire of Northam

USER: Kathy Scholz
PAGE: 49

Cheque /EFT No	Date	Name	Invoice Description	Bank Code	INV Amount	Amount
EFT35249	17/12/2019	MACKENZIE SARGENT	TRAVEL SUBSIDY FOR FLOORBALL	1		300.00
INV RR30/10/30/10/2019		MACKENZIE SARGENT	TRAVEL SUBSIDY FOR FLOORBALL	1	300.00	
35250	12/12/2019	SYNERGY	VISITORS CENTRE 27/09/2019-27/11/2019	1		2,061.33
INV 3355969227/11/2019		SYNERGY	VISITORS CENTRE 27/09/2019-27/11/2019	1	1,425.21	
INV 9356001427/11/2019		SYNERGY	VISITORS CENTRE CONF ROOM 27/09/2019-27/11/2019	1	636.12	
EFT35250	17/12/2019	MALINOWSKI HOLDINGS PTY LTD	RENT 174 FITZGERALD STREET, NORTHAM - JULY 2019	1		916.66
INV 0000279	30/11/2019	MALINOWSKI HOLDINGS PTY LTD	RENT 174 FITZGERALD STREET, NORTHAM - JULY 2019	1	916.66	
35251	12/12/2019	TELSTRA CORPORATION	MAIN LANDLINE NOV-DEC 2019	1		8,582.26
INV 2726008910/11/2019		TELSTRA CORPORATION	BFB 10/11/2019-09/12/2019	1	609.98	
INV 3864754812/11/2019		TELSTRA CORPORATION	HENRY ST OVAL TO 04/11/2019	1	80.00	
INV 9026075012/11/2019		TELSTRA CORPORATION	MAIN LANDLINE NOV-DEC 2019	1	7,816.44	
INV 2000049020/11/2019		TELSTRA CORPORATION	SES 15/10/2019-14/11/2019	1	39.95	
INV 6305302927/11/2019		TELSTRA CORPORATION	BAKERS HILL BFB TO 22/11/2019	1	35.89	
EFT35251	17/12/2019	MARKETFORCE	ADVERT IN THE AVON VALLEY ADVOCATE ON 13/11/2019 AND SEEK FOR DEVELOPMENT SERVICES TRAINEE & HORTICULTURE TRAINEE X2	1		1,899.99
INV 30910	26/11/2019	MARKETFORCE	ADVERT IN THE AVON VALLEY ADVOCATE ON 13/11/2019 AND SEEK FOR DEVELOPMENT SERVICES TRAINEE & HORTICULTURE TRAINEE X2	1	1,300.02	
INV 30911	26/11/2019	MARKETFORCE	GORDON PLACE ROAD CLOSURE - AVON VALLEY ADVOCATE 27/11/2019	1	240.75	
INV 30909	26/11/2019	MARKETFORCE	PUBLIC NOTICE IN THE AVON VALLEY ADVOCATE 06/11/2019 FOR THE ADOPTION OF THE CAT, FENCING AND PARKING LOCAL LAWS	1	359.22	
35252	12/12/2019	WATER CORPORATION	SWIMMING POOL HOUSE 21/09/2019 TO 18/11/2019.	1		427.99
INV 9011154706/11/2019		WATER CORPORATION	VACAN LAND 02/09/2019-05/11/2019	1	158.55	
INV 9007923619/11/2019		WATER CORPORATION	SWIMMING POOL HOUSE 21/09/2019 TO 18/11/2019.	1	269.44	

Ordinary Council Meeting Minutes
22 January 2020

Date: 07/01/2020
Time: 8:12:43AM

Shire of Northam

USER: Kathy Scholz
PAGE: 50

Cheque /EFT No	Date	Name	Invoice Description	Bank Code	INV Amount	Amount
EFT35252	17/12/2019	MR NATURALLY CLEAN	SECURITY FOR VARIOUS BUILDINGS.	1		2,871.00
INV INV-174830/11/2019		MR NATURALLY CLEAN	SECURITY FOR VARIOUS BUILDINGS.	1	2,871.00	
35253	17/12/2019	SHIRE OF CHITTERING	REIMBURSEMENT FOR LONG SERVICE LEAVE FOR NATHAN GOUGH.	1		14,590.45
INV 13575	18/10/2019	SHIRE OF CHITTERING	REIMBURSEMENT FOR LONG SERVICE LEAVE FOR NATHAN GOUGH.	1	14,590.45	
EFT35253	17/12/2019	NORTHAM BETTA ELECTRICAL	BE CONNECTED GRANT - HP 14 INCH HD245 G7 NOTEBOOK	1		2,446.00
INV 2001000004/12/2019		NORTHAM BETTA ELECTRICAL	BE CONNECTED GRANT - HP 14 INCH HD245 G7 NOTEBOOK	1	2,146.00	
INV 2001000704/12/2019		NORTHAM BETTA ELECTRICAL	EVAPORATIVE AIR COOLER	1	300.00	
35254	17/12/2019	SHIRE OF NORTHAM SOCIAL CLUB	Payroll deductions	1		60.00
INV DEDUCT10/12/2019		SHIRE OF NORTHAM SOCIAL CLUB	Payroll deductions		60.00	
EFT35254	17/12/2019	NORTHAM FAMILY PRACTICE	PRE-EMPLOYMENT MEDICAL - TREVOR HEASLIP	1		236.50
INV 118009	15/11/2019	NORTHAM FAMILY PRACTICE	PRE-EMPLOYMENT MEDICAL - TREVOR HEASLIP	1	236.50	
35255	17/12/2019	SYNERGY	AIRPORT 19/09/2019-18/11/2019	1		3,274.68
INV 1365377418/11/2019		SYNERGY	AIRPORT 19/09/2019-18/11/2019	1	3,274.68	
EFT35255	17/12/2019	NORTHAM FEED & HIRE	DOG & CAT FOOD & OTHER MISCELLANEOUS ITEMS - DEC EMBER	1		175.50
INV 0000249827/11/2019		NORTHAM FEED & HIRE	DOG & CAT FOOD AND OTHER MISCELLANEOUS ITEMS - NOVEMBER 2019.	1	16.50	
INV 0000249928/11/2019		NORTHAM FEED & HIRE	DOG & CAT FOOD & OTHER MISCELLANEOUS ITEMS - NOVEMBER	1	16.50	
INV 0000250529/11/2019		NORTHAM FEED & HIRE	DOG & CAT FOOD & OTHER MISCELLANEOUS ITEMS - NOVEMBER	1	16.50	
INV 0000250602/12/2019		NORTHAM FEED & HIRE	DOG & CAT FOOD & OTHER MISCELLANEOUS ITEMS - DEC EMBER	1	16.50	
INV 0000250904/12/2019		NORTHAM FEED & HIRE	DOG & CAT FOOD & OTHER MISCELLANEOUS ITEMS - DEC EMBER	1	16.50	

Ordinary Council Meeting Minutes
22 January 2020



Date: 07/01/2020
Time: 8:12:43AM

Shire of Northam

USER: Kathy Scholz
PAGE: 51

Cheque /EFT No	Date	Name	Invoice Description	Bank Code	INV Amount	Amount
INV 0000251705/12/2019		NORTHAM FEED & HIRE	DOG & CAT FOOD & OTHER MISCELLANEOUS ITEMS - DEC EMBER	1	60.00	
INV 0000251806/12/2019		NORTHAM FEED & HIRE	DOG & CAT FOOD & OTHER MISCELLANEOUS ITEMS - DEC EMBER	1	16.50	
INV 0000251909/12/2019		NORTHAM FEED & HIRE	DOG & CAT FOOD & OTHER MISCELLANEOUS ITEMS - DEC EMBER	1	16.50	
35256	17/12/2019	TELSTRA CORPORATION	MAINLINE DEC 2019-JAN 2020	1		11,125.53
INV 2726009028/11/2019		TELSTRA CORPORATION	KILLARA & ENGINEERING 28/11/2019-27/12/2019	1	103.50	
INV 2726008928/11/2019		TELSTRA CORPORATION	MAIN MOBILE ACCOUNT NOV 2019-DEC 2019	1	3,131.62	
INV 9026075012/12/2019		TELSTRA CORPORATION	MAINLINE DEC 2019-JAN 2020	1	7,890.41	
EFT35256	17/12/2019	NORTHAM MITRE 10 SOLUTIONS	56V MULTI TOOL HEDGE TRIMMER	1		2,483.94
INV 1047851108/11/2019		NORTHAM MITRE 10 SOLUTIONS	56V MULTI TOOL HEDGE TRIMMER	1	649.00	
INV 1047885109/11/2019		NORTHAM MITRE 10 SOLUTIONS	DIAMOND SAW BLADE FOR QUICKCUT SAW	1	472.30	
INV 1047961111/11/2019		NORTHAM MITRE 10 SOLUTIONS	FERTILIZER & RETIC HOSE	1	65.03	
INV 1048031113/11/2019		NORTHAM MITRE 10 SOLUTIONS	ROLL OF ROPE FOR TARP'S	1	24.00	
INV 1048041413/11/2019		NORTHAM MITRE 10 SOLUTIONS	Contact adhesive	1	40.20	
INV 1048081114/11/2019		NORTHAM MITRE 10 SOLUTIONS	ADMIN BUILDING. SUPPLY ASSORTED SCREWS.	1	39.91	
INV 1048101615/11/2019		NORTHAM MITRE 10 SOLUTIONS	GOLF VALVE BOX	1	52.96	
INV 1048212418/11/2019		NORTHAM MITRE 10 SOLUTIONS	750G COOCH LAWN SEED FOR BERT HAWKE OVAL.	1	90.68	
INV 1048256219/11/2019		NORTHAM MITRE 10 SOLUTIONS	FITTINGS FOR WUNDOWIE POOL.	1	128.69	
INV 1048246619/11/2019		NORTHAM MITRE 10 SOLUTIONS	90 DEGREE BRACKET'S	1	632.38	
INV 1048296620/11/2019		NORTHAM MITRE 10 SOLUTIONS	THREE PRONGED WEEDING FORKS	1	92.63	
INV 1048269820/11/2019		NORTHAM MITRE 10 SOLUTIONS	PAINT MIXER	1	29.45	
INV 1048329721/11/2019		NORTHAM MITRE 10 SOLUTIONS	TAP FITTINGS	1	32.82	
INV 1048370822/11/2019		NORTHAM MITRE 10 SOLUTIONS	LARGE BOX OF TEK SCREWS LARGE	1	133.89	

Ordinary Council Meeting Minutes
22 January 2020

Date: 07/01/2020
Time: 8:12:43AM

Shire of Northam

USER: Kathy Scholz
PAGE: 52

Cheque /EFT No	Date	Name	Invoice Description	Bank Code	INV Amount	Amount
EFT35257	17/12/2019	NORTHAM TOWING SERVICE	REMOVE RED HOLDEN COMMODORE EQUIP FROM CORNER OF BURN AND THROSSSELL STREETS	1		88.00
INV 209053	05/12/2019	NORTHAM TOWING SERVICE	REMOVE RED HOLDEN COMMODORE EQUIP FROM CORNER OF BURN AND THROSSSELL STREETS	1	88.00	
35257	20/12/2019	SHIRE OF NORTHAM SOCIAL CLUB	Payroll deductions	1		60.00
INV DEDUCT24	12/2019	SHIRE OF NORTHAM SOCIAL CLUB	Payroll deductions		60.00	
EFT35258	17/12/2019	OFFICEWORKS SUPERSTORES PTY LTD	REXEL GIANT FULL STRIP STAPLER	1		1,333.66
INV 4548074322	11/2019	OFFICEWORKS SUPERSTORES PTY LTD	REXEL GIANT FULL STRIP STAPLER	1	815.71	
INV 4548595822	11/2019	OFFICEWORKS SUPERSTORES PTY LTD	PENRITE PREMIUM MAGNETIC WHITEBOARD 1500 X 1200MM	1	517.95	
35258	20/12/2019	SYNERGY	STREET LIGHTS 01/11/2019-02/12/2019	1		24,329.02
INV 3322736322	10/2019	SYNERGY	CLACKLINE POSTE OFFICE 23/09/2019-22/10/2019	1	81.81	
INV 2361098029	11/2019	SYNERGY	RAP PARK AVON YOUTH 02/10/2019-29/11/2019	1	118.89	
INV 9152416402	12/2019	SYNERGY	AUXILLARY LIGHTING CHARGES 01/11/2019-02/12/2019	1	139.62	
INV 1686149902	12/2019	SYNERGY	STREET LIGHTS 01/11/2019-02/12/2019	1	23,988.70	
EFT35259	17/12/2019	PALMER CIVIL CONSTRUCTION	CONTRACT C.201920-01 - REINSTATEMENT REPAIRS TO FLOOD DAMAGED INFRASTRUCTURE. WANDRRA AGRN 822	1		463,677.57
INV 0000259209	12/2019	PALMER CIVIL CONSTRUCTION	CONTRACT C.201920-01 - REINSTATEMENT REPAIRS TO FLOOD DAMAGED INFRASTRUCTURE. WANDRRA AGRN 822	1	463,677.57	
35259	20/12/2019	TELSTRA CORPORATION	VEMS TRAILER, SPRINKLERS 28/11/2019-27/12/2019	1		50.00
INV 2726009028	11/2019	TELSTRA CORPORATION	VEMS TRAILER, SPRINKLERS 28/11/2019-27/12/2019	1	50.00	
EFT35260	17/12/2019	PERTH ENERGY PTY LTD	ELECTRICITY CHARGES FOR ACCOUNT 601148 - 185 FITZGERALD ST NORTHAM - STATEMENT NO 2180098.	1		299.16
INV 2180098	16/12/2019	PERTH ENERGY PTY LTD	ELECTRICITY CHARGES FOR ACCOUNT 601148 - 185 FITZGERALD ST NORTHAM - STATEMENT NO 2180098.	1	299.16	

Ordinary Council Meeting Minutes
22 January 2020



Date: 07/01/2020
Time: 8:12:43AM

Shire of Northam

USER: Kathy Scholz
PAGE: 53

Cheque /EFT No	Date	Name	Invoice Description	Bank Code	INV Amount	Amount
EFT35261	17/12/2019	PERTH SAFETY PRODUCTS PTY LTD	MTO 1200X200 ROAD INSPECTION MAGNETIC BLACK ON YELLOW AS PER QUOTE 11119514	1		1,083.50
INV 0000947512/11/2019		PERTH SAFETY PRODUCTS PTY LTD	REFLECTIVE 'CHEVRONS' (FOR NCS11122)	1	467.50	
INV 0000949618/11/2019		PERTH SAFETY PRODUCTS PTY LTD	REFLECTIVE BLUE BLADE 'FIRE SHED' (ICS 91395)	1	55.00	
INV 0000951425/11/2019		PERTH SAFETY PRODUCTS PTY LTD	MTO 1200X200 ROAD INSPECTION MAGNETIC BLACK ON YELLOW AS PER QUOTE 11119514	1	561.00	
EFT35262	17/12/2019	PRECISION LASER SYSTEMS	RECALIBRATE LASER AND ALSO REPAIR OF 'PICK UP' BRACKET	1		156.20
INV 0003602018/11/2019		PRECISION LASER SYSTEMS	RECALIBRATE LASER AND ALSO REPAIR OF 'PICK UP' BRACKET	1	156.20	
EFT35263	17/12/2019	PREMIER PAVING AND SITE SERVICES ARTROSE CONTRACTING SERVICES PTY LTD	REFUND OF DEPOSIT FOR STANDPIPE KEY	1		50.00
INV 129833	12/12/2019	PREMIER PAVING AND SITE SERVICES ARTROSE CONTRACTING SERVICES PTY LTD	REFUND OF DEPOSIT FOR STANDPIPE KEY	1	50.00	
EFT35264	17/12/2019	PRICEMARK PTY LTD	WRIST BAND WITH LOGOS IN VARIOUS COLOURS.	1		680.00
INV 0007971803/12/2019		PRICEMARK PTY LTD	WRIST BAND WITH LOGOS IN VARIOUS COLOURS.	1	680.00	
EFT35265	17/12/2019	QUALITY PUBLISHING AUSTRALIA	STOCK PURCHASES FOR VISITORS CENTRE.	1		184.32
INV 0004674425/11/2019		QUALITY PUBLISHING AUSTRALIA	STOCK PURCHASES FOR VISITORS CENTRE.	1	184.32	
EFT35266	17/12/2019	SHIRE OF TOODYAY	TRAINING IN NORTHAM FOR CR.GALLOWAY, CR. ANTONIO, CR WILLIAMS AND CR TINETTI	1		1,050.00
INV 18333	29/11/2019	SHIRE OF TOODYAY	TRAINING IN NORTHAM FOR CR.GALLOWAY, CR. ANTONIO, CR WILLIAMS AND CR TINETTI	1	1,050.00	
EFT35267	17/12/2019	SOUTHERN BROOK COMMUNITY ASSOCIATION	SOUTHERN BROOK COMMUNITY ASSOCIATION ANNUAL ALLOCATION 2019/20.	1		3,300.00
INV 2019/20	14/12/2019	SOUTHERN BROOK COMMUNITY ASSOCIATION	SOUTHERN BROOK COMMUNITY ASSOCIATION ANNUAL ALLOCATION 2019/20.	1	3,300.00	
EFT35268	17/12/2019	SOUTHERN CROSS AUSTRALIA PTY LTD	AROUND THE TOWNS 2019/20 - SHIRE PRESIDENT INTERVIEWS	1		88.00

Ordinary Council Meeting Minutes
22 January 2020



Date: 07/01/2020
Time: 8:12:43AM

Shire of Northam

USER: Kathy Scholz
PAGE: 54

Cheque /EFT No	Date	Name	Invoice Description	Bank Code	INV Amount	Amount
INV 7095162630	11/2019	SOUTHERN CROSS AUSTEREO PTY LTD	AROUND THE TOWNS 2019/20 - SHIRE PRESIDENT INTERVIEWS	1	88.00	
EFT35269	17/12/2019	SPECIALISED TREE SERVICE	ANNUAL TOWNSITE PRUNING WUNDOWIE AS PER C.201819-09 - SCHEDULE OF RATES	1		7,994.87
INV 3201	16/12/2019	SPECIALISED TREE SERVICE	ANNUAL TOWNSITE PRUNING WUNDOWIE AS PER C.201819-09 - SCHEDULE OF RATES	1	7,994.87	
EFT35270	17/12/2019	THE PAPER COMPANY OF AUSTRALIA	X 100 REAMS A4 PHOTOCOPY PAPER	1		500.50
INV 0004548505	12/2019	THE PAPER COMPANY OF AUSTRALIA	X 100 REAMS A4 PHOTOCOPY PAPER	1	500.50	
EFT35271	17/12/2019	WARRICKS NEWSAGENCY	NEWSPAPERS FOR LIBRARY 2019	1		316.24
INV 56424	11/11/2019	WARRICKS NEWSAGENCY	CANON 1600XL BLACK FOR KILLARA FAX MACHINE	1		83.12
INV SN0000622	11/2019	WARRICKS NEWSAGENCY	ADMIN - NEWSPAPERS - NOVEMBER 2019	1		82.20
INV SN00017301	12/2019	WARRICKS NEWSAGENCY	NEWSPAPERS FOR LIBRARY 2019	1		150.92
EFT35272	17/12/2019	WESTERN AUSTRALIAN LOCAL GOVERNMENT ASSOCIATION	TENDER MANAGEMENT SERVICES FOR SHIRE OF NORTHAM'S INKPEN ROAD WASTE FACILITY'S MANAGMENT CONTRACT.	1		3,655.38
INV B080063	21/11/2019	WESTERN AUSTRALIAN LOCAL GOVERNMENT ASSOCIATION	TENDER MANAGEMENT SERVICES FOR SHIRE OF NORTHAM'S INKPEN ROAD WASTE FACILITY'S MANAGMENT CONTRACT.	1	3,476.88	
INV B080223	05/12/2019	WESTERN AUSTRALIAN LOCAL GOVERNMENT ASSOCIATION	WALGA DESK PAD CALENDARS - ANTHONY SVANBERG	1		178.50
EFT35273	17/12/2019	WHEATBELT NATURAL RESOURCE MANAGEMENT	WEEKLY MAINTENANCE OF NORTHAM CEMETERY AS PER ON GOING CONTRACT * CEMETERY MAINTENANCE 29/10/2019 TO 08/11/2019.	1		10,907.60
INV 0030105415	11/2019	WHEATBELT NATURAL RESOURCE MANAGEMENT	WEEKLY MAINTENANCE OF NORTHAM CEMETERY AS PER ON GOING CONTRACT * CEMETERY MAINTENANCE 29/10/2019 TO 08/11/2019.	1	2,853.40	
INV 0030105315	11/2019	WHEATBELT NATURAL RESOURCE MANAGEMENT	WEEKLY MAINTENANCE OF NORTHAM CEMETERY AS PER ON GOING CONTRACT * CEMETERY MAINTENANCE 15/10/2019 TO 24/10/2019.	1	2,853.40	

Ordinary Council Meeting Minutes
22 January 2020

Date: 07/01/2020
Time: 8:12:43AM

Shire of Northam

USER: Kathy Scholz
PAGE: 55

Cheque /EFT No	Date	Name	Invoice Description	Bank Code	INV Amount	Amount
INV 0030105215/11/2019		WHEATBELT NATURAL RESOURCE MANAGEMENT	WEEKLY MAINTENANCE OF NORTHAM CEMETERY AS PER ON GOING CONTRACT ' CEMETERY MAINTENANCE 03/10/2019 TO 11/10/2019.	1	2,853.40	
INV 0030105602/12/2019		WHEATBELT NATURAL RESOURCE MANAGEMENT	WEEKLY MAINTENANCE OF NORTHAM CEMETERY AS PER ON GOING CONTRACT ' CEMETERY MAINTENANCE 12/1/2019 TO 22/11/2019.	1	2,347.40	
EFT35274	17/12/2019	WHEATBELT OFFICE & BUSINESS MACHINES	PRINTER CARTRIDGE - HP62 BLACK	1		59.40
INV 25542	19/11/2019	WHEATBELT OFFICE & BUSINESS MACHINES	PRINTER CARTRIDGE - HP62 BLACK	1	59.40	
EFT35275	17/12/2019	WHEATBELT SAFETYWEAR	PAIRS OF GLOVES (BACKUP RANGER ASSISTANTS)	1		128.00
INV 9166	05/12/2019	WHEATBELT SAFETYWEAR	PAIRS OF GLOVES (BACKUP RANGER ASSISTANTS)	1	128.00	
EFT35276	17/12/2019	ZENIEN	ADMIN WIRELESS LINKS FOR REMOTE OFFICES FOR DATA AND NEW VOIP PHONE SYSTEM	1		12,616.34
INV 16878	23/10/2019	ZENIEN	ADMIN WIRELESS LINKS FOR REMOTE OFFICES FOR DATA AND NEW VOIP PHONE SYSTEM	1	12,162.59	
INV 17046	09/12/2019	ZENIEN	CCTV SYSTEMS CONSULTING/INSTALLATION - .	1	453.75	
EFT35277	20/12/2019	ADAGE FURNITURE	CHAIRS FOR REC CENTRE.	1		3,832.40
INV 16112	13/12/2019	ADAGE FURNITURE	CHAIRS FOR REC CENTRE.	1	3,832.40	
EFT35278	20/12/2019	ADVANCED TRAFFIC MANAGEMENT (WA) PTY LTD	CHRISTMAS ON FITZGERALD 2019: TMP UPDATE ONLY	1		347.60
INV 0013170928/11/2019		ADVANCED TRAFFIC MANAGEMENT (WA) PTY LTD	CHRISTMAS ON FITZGERALD 2019: TMP UPDATE ONLY	1	347.60	
EFT35279	20/12/2019	AG IMPLEMENTS NORTHAM PTY LTD	LUB6006 OIL 2-STROKE 4L	1		388.13
INV 383516	27/11/2019	AG IMPLEMENTS NORTHAM PTY LTD	DRAIN OIL IN TANK - REPLACE SIGHT GLASS - RE FILL - TOP UP ON PN1207 - REGO N10863	1	164.02	
INV 383474	27/11/2019	AG IMPLEMENTS NORTHAM PTY LTD	LUB6006 OIL 2-STROKE 4L	1	224.11	
EFT35280	20/12/2019	ANDY'S PLUMBING SERVICE	PUMP OUT AND CLEAN WASHDOWN PAD SUMP	1		1,265.00
INV A.18576	27/11/2019	ANDY'S PLUMBING SERVICE	PUMP OUT AND CLEAN WASHDOWN PAD SUMP	1	1,265.00	

Ordinary Council Meeting Minutes
22 January 2020



Date: 07/01/2020
Time: 8:12:43AM

Shire of Northam

USER: Kathy Scholz
PAGE: 56

Cheque /EFT No	Date	Name	Invoice Description	Bank Code	INV Amount	Amount
EFT35281	20/12/2019	ANGIE ROE PHOTOGRAPHY	PHOTOGRAPHY FOR CHRISTMAS ON FITZGERALD EVENT 2019- 5PM-9PM	1		1,195.00
INV 55218	15/12/2019	ANGIE ROE PHOTOGRAPHY	PHOTOGRAPHY FOR CHRISTMAS ON FITZGERALD EVENT 2019- 5PM-9PM	1	1,195.00	
EFT35282	20/12/2019	APPLIED INDUSTRIAL TECHNOLOGIES T/A NORTHAM BEARINGS	TIE DOWN STRAPS	1		110.00
INV 6419765	03/12/2019	APPLIED INDUSTRIAL TECHNOLOGIES T/A NORTHAM BEARINGS	TIE DOWN STRAPS	1	110.00	
EFT35283	20/12/2019	AUSTRALIA POST	POSTAGE FOR KILLARA, VISITORS CENTRE AND ADMIN -NOVEMBER 2019.	1		2,355.50
INV 1009130303	12/2019	AUSTRALIA POST	POSTAGE FOR KILLARA, VISITORS CENTRE AND ADMIN -NOVEMBER 2019.	1	2,355.50	
EFT35284	20/12/2019	AUSTRALIAN SERVICES UNION	Payroll deductions	1		257.00
INV DEDUCT24	12/2019	AUSTRALIAN SERVICES UNION	Payroll deductions		257.00	
EFT35285	20/12/2019	AUSTRALIAN TAXATION OFFICE - PAYG	PAYG PAY RUN WEEK END 24/12/2019.	1		148,399.08
INV PAYG10	10/12/2019	AUSTRALIAN TAXATION OFFICE - PAYG	PAYG PAY RUN 10/12/2019 LESS \$872 KEVEN JONES REVERSAL	1	68,045.61	
INV PAYG 2420	12/2019	AUSTRALIAN TAXATION OFFICE - PAYG	PAYG PAY RUN WEEK END 24/12/2019.	1	80,353.47	
EFT35286	20/12/2019	AVON VALLEY CONTRACTORS	FERTILISER BAG	1		162.50
INV 28155	10/12/2019	AVON VALLEY CONTRACTORS	FERTILISER BAG	1	162.50	
EFT35288	20/12/2019	BELINGARNI FABRICATION HOME AND PROPERTY SERVICES	FUEL LOAD REDUCTION	1		805.00
INV 610	12/12/2019	BELINGARNI FABRICATION HOME AND PROPERTY SERVICES	FUEL LOAD REDUCTION	1	805.00	
EFT35289	20/12/2019	BOEKEMAN MACHINERY	TO REMOVE AND REPLACE NEW BRAKE DISCS- PARTS +LABOUR AS PER ESTIMATION N-10863 FOR PN 1207 - REGO N10863	1		4,434.15
INV 276251	01/11/2019	BOEKEMAN MACHINERY	Aircon filters for Case JXU85 Tractor	1	172.99	

Ordinary Council Meeting Minutes
22 January 2020

Date: 07/01/2020
Time: 8:12:43AM

Shire of Northam

USER: Kathy Scholz
PAGE: 57

Cheque /EFT No	Date	Name	Invoice Description	Bank Code	INV Amount	Amount
INV 277459	14/11/2019	BOEKEMAN MACHINERY	TO REMOVE AND REPLACE NEW BRAKE DISCS - PARTS +LABOUR AS PER ESTIMATION N-10863 FOR PN 1207 - REGO N10863	1	4,083.93	
INV 279540	04/12/2019	BOEKEMAN MACHINERY	CAN - WAX OIL	1	177.23	
EFT35290	20/12/2019	BRICK MART	BRICKS FOR SHIRE OF NORTHAM WUNDOWIE	1		57.00
INV 90139	30/11/2019	BRICK MART	BRICKS FOR SHIRE OF NORTHAM WUNDOWIE	1	57.00	
EFT35291	20/12/2019	CDA AIR & SOLAR	REPAIRS TO RAILWAYS COOL ROOM - TEMPERATURE READING TOO HIGH PLUS LABOUR	1		240.00
INV 0000856117/12/2019		CDA AIR & SOLAR	REPAIRS TO RAILWAYS COOL ROOM - TEMPERATURE READING TOO HIGH PLUS LABOUR	1	240.00	
EFT35292	20/12/2019	CENTRAL MOBILE MECHANICAL REPAIRS	CLACKLINE 24 - DIAGNOSE AND REPAIR AUXILLARY PUMP	1		587.62
INV 0000297709/12/2019		CENTRAL MOBILE MECHANICAL REPAIRS	CLACKLINE 24 - DIAGNOSE AND REPAIR AUXILLARY PUMP	1	587.62	
EFT35293	20/12/2019	CITY COUNTRY SALES & DISTRIBUTION PTY LTD	SUNSATONAL SUNSCREEN SPF50+	1		189.84
INV 0001444202/12/2019		CITY COUNTRY SALES & DISTRIBUTION PTY LTD	SUNSATONAL SUNSCREEN SPF50+	1	189.84	
EFT35294	20/12/2019	COCA-COLA AMATIL (AUST) PTY LTD	STOCK PURCHASES FOR NORTHAM POOL.	1		1,761.38
INV 2215246911/12/2019		COCA-COLA AMATIL (AUST) PTY LTD	STOCK PURCHASES FOR REC CENTRE.	1	445.74	
INV 2215246911/12/2019		COCA-COLA AMATIL (AUST) PTY LTD	STOCK PURCHASES FOR NORTHAM POOL.	1	1,315.64	
EFT35295	20/12/2019	COLIN EVAN WHISSON	CHRISTMAS ON FITZGERALD 2019: ANOTHER FINE MESS (BAND)	1		1,800.00
INV 2019121313/11/2019		COLIN EVAN WHISSON	CHRISTMAS ON FITZGERALD 2019: ANOTHER FINE MESS (BAND)	1	1,800.00	
EFT35296	20/12/2019	CORPORATE SECURITY AUSTRALIA PTY LTD	CHRISTMAS ON FITZGERALD 2019: SECURITY	1		1,374.18
INV 0000415817/12/2019		CORPORATE SECURITY AUSTRALIA PTY LTD	CHRISTMAS ON FITZGERALD 2019: SECURITY	1	1,374.18	

Ordinary Council Meeting Minutes
22 January 2020



Date: 07/01/2020
Time: 8:12:43AM

Shire of Northam

USER: Kathy Scholz
PAGE: 58

Cheque /EFT No	Date	Name	Invoice Description	Bank Code	INV Amount	Amount
EFT35297	20/12/2019	COUNTRYWIDE GROUP	Whipper snippers to be repaired	1		183.01
INV 28448	14/11/2019	COUNTRYWIDE GROUP	Whipper snippers to be repaired	1	116.00	
INV 28553	05/12/2019	COUNTRYWIDE GROUP	2M PULL CORD FOR SMALL PLANT ITEMS.	1	15.00	
INV 28609	12/12/2019	COUNTRYWIDE GROUP	POOL SCOOP	1	52.01	
EFT35298	20/12/2019	DALLIMORE CARPETS	VISITORS CENTRE. REPLACE VINYL TO MENS TOILET AS PER QUOTE 7798AK	1		2,475.00
INV 10800	30/11/2019	DALLIMORE CARPETS	VISITORS CENTRE. REPLACE VINYL TO MENS TOILET AS PER QUOTE 7798AK	1	2,475.00	
EFT35299	20/12/2019	DAMIAN'S PLUMBING	WATER FOUNTAIN WONT TURN OFF MORRELL PARK	1		116.60
INV 4828	27/11/2019	DAMIAN'S PLUMBING	WATER FOUNTAIN WONT TURN OFF MORRELL PARK	1	116.60	
EFT35300	20/12/2019	DORMAKABA AUSTRALIA PTY LTD	REC CENTRE. SERVICE AUTO MATIC SLIDING DOOR.	1		450.36
INV 35WA-6926/11/2019		DORMAKABA AUSTRALIA PTY LTD	REC CENTRE. SERVICE AUTO MATIC SLIDING DOOR.	1	450.36	
EFT35301	20/12/2019	E & J LOGISTIC PTY LTD T/AS FLAT OUT FREIGHT	PICK UP FROM FULTON & HOGAN 4XIBC OF EMULSION AND PALLET OF EMUSEAL AND DELIVER TO SHIRE OF NORTHAM DEPOT IN NORTHAM	1		527.00
INV 0000125830/11/2019		E & J LOGISTIC PTY LTD T/AS FLAT OUT FREIGHT	PICK UP GRADER BLADES 22X 6 FT LONG TOTAL WEIGHT 651KG	1	87.00	
INV 0000125830/11/2019		E & J LOGISTIC PTY LTD T/AS FLAT OUT FREIGHT	PICK UP FROM FULTON & HOGAN 4XIBC OF EMULSION AND PALLET OF EMUSEAL AND DELIVER TO SHIRE OF NORTHAM DEPOT IN NORTHAM	1	440.00	
EFT35302	20/12/2019	EASIFLEET	Payroll deductions	1		3,036.10
INV DEDUCT24/12/2019		EASIFLEET	Payroll deductions		1,421.55	
INV DEDUCT24/12/2019		EASIFLEET	Payroll deductions		1,614.55	
EFT35303	20/12/2019	FLOCON ENGINEERING PTY LTD	SUPPLY SHOVEL BUCKET (BOLT ON ITEM TO STORE SHOVELS IN) HINO 500 SERIES FLOCON - VIN# JHDFG&JPMXXX10072 ON PN1201 - REGO N.008	1		528.00

Ordinary Council Meeting Minutes
22 January 2020



Date: 07/01/2020
Time: 8:12:43AM

Shire of Northam

USER: Kathy Scholz
PAGE: 59

Cheque /EFT No	Date	Name	Invoice Description	Bank Code	INV Amount	Amount
INV INV-252506/12/2019		FLOCON ENGINEERING PTY LTD	SUPPLY SHOVEL BUCKET (BOLT ON ITEM TO STORE SHOVELS IN) HINO 500 SERIES FLOCON - VIN# JHDFG8JEMXXX10072 ON FN1201 - REGO N.008	1	528.00	
EFT35304	20/12/2019	FORREST EVENTS	CHRISTMAS ON FITZGERALD 2019: 15X PICNIC TABLES AND BENCHES NOTE: SAME DAY DELIVERY AND COLLECTION.	1		1,350.00
INV 15	16/12/2019	FORREST EVENTS	CHRISTMAS ON FITZGERALD 2019: 15X PICNIC TABLES AND BENCHES NOTE: SAME DAY DELIVERY AND COLLECTION.	1	1,350.00	
EFT35305	20/12/2019	GRAFTON ELECTRICS	EMERGENCY REPAIRS TO THE NORTHAM POOL CLEANER PLUS LABOUR	1		699.60
INV 6510	11/12/2019	GRAFTON ELECTRICS	EMERGENCY REPAIRS TO THE NORTHAM POOL CLEANER PLUS LABOUR	1	297.00	
INV 6506	11/12/2019	GRAFTON ELECTRICS	REPAIRS TO LIGHTS AT NORTHAM RECREATION CENTRE PLUS LABOUR	1	165.00	
INV 6533	17/12/2019	GRAFTON ELECTRICS	REPAIR LIGHTS OUTSIDE AUTOMATIC DOORS. (TIME CLOCK WITH RESERVE PLUS LABOUR)	1	237.60	
EFT35306	20/12/2019	INSTANT PRODUCTS HIRE	CHRISTMAS ON FITZGERALD 2019: 4X TOILETS + 2X DISABLED TOILETS NOTE: SAME DAY DELIVERY AND COLLECTION.	1		1,561.89
INV 91909	19/12/2019	INSTANT PRODUCTS HIRE	CHRISTMAS ON FITZGERALD 2019: 4X TOILETS + 2X DISABLED TOILETS NOTE: SAME DAY DELIVERY AND COLLECTION.	1	1,561.89	
EFT35307	20/12/2019	J & A BUILDING PTY LTD	NORTHAM LIBRARY. INSTALL CAGE AROUND HWS.	1		396.00
INV 0000261606/12/2019		J & A BUILDING PTY LTD	NORTHAM LIBRARY. INSTALL CAGE AROUND HWS.	1	396.00	
EFT35308	20/12/2019	KLEENWEST DISTRIBUTORS	CLEANING PRODUCTS FOR REC CENTRE.	1		3,074.02
INV 0004216319/11/2019		KLEENWEST DISTRIBUTORS	CARTONS OF TOILET ROLLS	1	981.92	
INV 0004249304/12/2019		KLEENWEST DISTRIBUTORS	ASSORTED CHEMICALS, PPE & STOCK FOR KILLARA.	1	432.91	
INV 0004228404/12/2019		KLEENWEST DISTRIBUTORS	CREDIT FOR SWEET LU 200GM.	1	-184.14	
INV 0004275318/12/2019		KLEENWEST DISTRIBUTORS	CLEANING PRODUCTS FOR REC CENTRE.	1	1,843.33	

Ordinary Council Meeting Minutes
22 January 2020



Date: 07/01/2020
Time: 8:12:43AM

Shire of Northam

USER: Kathy Scholz
PAGE: 60

Cheque /EFT No	Date	Name	Invoice Description	Bank Code	INV Amount	Amount
EFT35309	20/12/2019	LUCY'S TEAROOMS	STAFF TRAINING LUNCH	1		166.00
INV 2056	21/11/2019	LUCY'S TEAROOMS	STAFF TRAINING LUNCH	1	166.00	
EFT35310	20/12/2019	MARQUEE MAGIC	CHRISTMAS ON FITZGERALD 2019: 30X MARQUEES WITH LIGHT, INSTALLATION & LATE REMOVAL	1		8,018.00
INV 1312-3	15/12/2019	MARQUEE MAGIC	CHRISTMAS ON FITZGERALD 2019: 15X WHITE PICKET FENCING PANELS + 9X MARQUEES WITH LIGHTS	1	2,138.00	
INV 1312-4	15/12/2019	MARQUEE MAGIC	CHRISTMAS ON FITZGERALD 2019: 30X MARQUEES WITH LIGHT, INSTALLATION & LATE REMOVAL	1	5,880.00	
EFT35311	20/12/2019	MINT CIVIL PTY LTD T/AS IMMACU SWEEP	STREET SWEEPING/GULLY EDUCATION SERVICES & TOWN CENTRE FOOTPATHS - 15/07/19 TO 21/07/19 - PER CONTRACT C.201819.	1		3,762.00
INV N2280	29/07/2019	MINT CIVIL PTY LTD T/AS IMMACU SWEEP	STREET SWEEPING/GULLY EDUCATION SERVICES & TOWN CENTRE FOOTPATHS - 15/07/19 TO 21/07/19 - PER CONTRACT C.201819.	1	3,762.00	
EFT35312	20/12/2019	NAVIGATOR PHOTOGRAFIX	PHOTOGRAPHS OF DOME (PHOTO NUMBER 102, 103) , NORTHAM AQUATIC CENTRE (PHOTO NUMBER 0023-3, 0004-5, 0016-2), HOCKEY TURF (PHOTO NUMBER 0044-2), NORTHAM TOWN CENTRE (PHOTO NUMBER 7286-2, 7313, 7267) AND THE NORTHAM YOUTH PRECINCT (PHOTO NUMBER 0021) AS PER QUOTE 1018.	1		850.00
INV 1015	17/12/2019	NAVIGATOR PHOTOGRAFIX	PHOTOGRAPHS OF DOME (PHOTO NUMBER 102, 103) , NORTHAM AQUATIC CENTRE (PHOTO NUMBER 0023-3, 0004-5, 0016-2), HOCKEY TURF (PHOTO NUMBER 0044-2), NORTHAM TOWN CENTRE (PHOTO NUMBER 7286-2, 7313, 7267) AND THE NORTHAM YOUTH PRECINCT (PHOTO NUMBER 0021) AS PER QUOTE 1018.	1	850.00	
EFT35313	20/12/2019	NOKTURNL EVENTS PTY LTD	CHRISTMAS ON FITZGERALD 2019: Transport, same day delivery & removal, dodgeballs, 2 x staff/umpires, generator (to inflate). Size is 14m x 7m.	1		1,800.00
INV INV-085620/11/2019		NOKTURNL EVENTS PTY LTD	CHRISTMAS ON FITZGERALD 2019: Transport, same day delivery & removal, dodgeballs, 2 x staff/umpires, generator (to inflate). Size is 14m x 7m.	1	1,800.00	

Ordinary Council Meeting Minutes
22 January 2020



Date: 07/01/2020
Time: 8:12:43AM

Shire of Northam

USER: Kathy Scholz
PAGE: 61

Cheque /EFT No	Date	Name	Invoice Description	Bank Code	INV Amount	Amount
EFT35314	20/12/2019	NORTHAM BETTA ELECTRICAL	NORTHAM LIBRARY. SUPPLY DISHLEX DISHWASHER DSE 6106 IN STAINLESS STEEL. CONTRACTOR TO PICK UP.	1		498.00
INV 2001000702/12/2019		NORTHAM BETTA ELECTRICAL	NORTHAM LIBRARY. SUPPLY DISHLEX DISHWASHER DSE 6106 IN STAINLESS STEEL. CONTRACTOR TO PICK UP.	1	498.00	
EFT35315	20/12/2019	NORTHAM COUNTRY CLUB INC	SENIOR SPORT FUNDING FOR PHILIP CUTMORE	1		100.00
INV 2917	17/12/2019	NORTHAM COUNTRY CLUB INC	SENIOR SPORT FUNDING FOR PHILIP CUTMORE	1	100.00	
EFT35316	20/12/2019	NORTHAM MITRE 10 SOLUTIONS	HOSES FOR SWIMMING POOLS.	1		1,116.08
INV 1048532727/11/2019		NORTHAM MITRE 10 SOLUTIONS	MAX FLOW NUT, COUPLING HOSE, COUPLER REDUCERS, POLY PIPE, SEED LAWN	1	79.42	
INV 1048600129/11/2019		NORTHAM MITRE 10 SOLUTIONS	25MM PN12 PVC PIPE AND FITTINGS	1	101.01	
INV 1048738203/12/2019		NORTHAM MITRE 10 SOLUTIONS	PVC FITTINGS	1	14.97	
INV 1048773004/12/2019		NORTHAM MITRE 10 SOLUTIONS	WILLOW 50L QUICKSERVE WHEELIE COOLER	1	117.00	
INV 1048799405/12/2019		NORTHAM MITRE 10 SOLUTIONS	PN 1810 - HOSE NOZZLE	1	19.82	
INV 1048808905/12/2019		NORTHAM MITRE 10 SOLUTIONS	BLUE LINE FITTINGS 25MM	1	77.05	
INV 1048818205/12/2019		NORTHAM MITRE 10 SOLUTIONS	NOZZLE - HOSE	1	112.54	
INV 1048854006/12/2019		NORTHAM MITRE 10 SOLUTIONS	WATERING CAN FOR FLOCON TRUCK	1	60.42	
INV 1048854306/12/2019		NORTHAM MITRE 10 SOLUTIONS	WILLOW 50L QUICKSERVE WHEELIE COOLER	1	99.00	
INV 1048844906/12/2019		NORTHAM MITRE 10 SOLUTIONS	RAILWAY MUSEUM. SUPPLY 12 x CANS OF FLY SPRAY.	1	49.88	
INV 1048852206/12/2019		NORTHAM MITRE 10 SOLUTIONS	SPRAYER TRIGGER 500ML	1	5.29	
INV 1048854206/12/2019		NORTHAM MITRE 10 SOLUTIONS	GARDEN FITTINGS	1	37.06	
INV 1049067512/12/2019		NORTHAM MITRE 10 SOLUTIONS	HOSES FOR SWIMMING POOLS.	1	342.62	
EFT35317	20/12/2019	OLD MACDONALD'S TRAVELLING FARMS	CHRISTMAS ON FITZGERALD 2019	1		825.00
INV 40065	03/12/2019	OLD MACDONALD'S TRAVELLING FARMS	CHRISTMAS ON FITZGERALD 2019	1	825.00	
EFT35318	20/12/2019	OLLY'S CAR & FURNITURE UPHOLSTERY'S	MAKE UP TARP AS PER QUOTE FOR PN0913	1		264.00

Ordinary Council Meeting Minutes
22 January 2020



Date: 07/01/2020
Time: 8:12:43AM

Shire of Northam

USER: Kathy Scholz
PAGE: 62

Cheque /EFT No	Date	Name	Invoice Description	Bank Code	INV Amount	Amount
INV 3498	03/12/2019	OLLY'S CAR & FURNITURE UPHOLSTERY'S	MAKE UP TARP AS PER QUOTE FOR PN0913	1	264.00	
EFT35319	20/12/2019	OXTER SERVICES	NORTHAM DEPOT. SUPPLY 1 X BOX HAND TOWEL, 2 X BOXES TOILET PAPER.	1		981.18
INV 22090	29/11/2019	OXTER SERVICES	BOXES OF 240L GARBAGE BAGS	1	172.43	
INV 22100	02/12/2019	OXTER SERVICES	NORTHAM DEPOT. SUPPLY 1 X BOX HAND TOWEL, 2 X BOXES TOILET PAPER.	1	370.01	
INV 22115	06/12/2019	OXTER SERVICES	CEMETERY TOILETS. SUPPLY 3 X TOILET ROLLS, 5KG URINAL BLOCKS AND 1 X BOX GLOVES.	1	268.59	
INV 22118	06/12/2019	OXTER SERVICES	SHRE ADMIN. SUPPLY 2 X BOXES OF ULTRA SLIM HANDTOWEL AND 2 BOXES X TOILET ROLLS.	1	170.15	
EFT35320	20/12/2019	PERTH AMUSEMENT & EVENT HIRE	CHRISTMAS ON FITZGERALD 2019: WILD SPLASH XL + IIL SPLASH + COMBO CASTLE (ALL WITH OPERATORS)	1		2,200.00
INV C0359	18/12/2019	PERTH AMUSEMENT & EVENT HIRE	CHRISTMAS ON FITZGERALD 2019: WILD SPLASH XL + IIL SPLASH + COMBO CASTLE (ALL WITH OPERATORS)	1	2,200.00	
EFT35321	20/12/2019	PERTH SAFETY PRODUCTS PTY LTD	3M RHS YELLOW SIGN MOUNTING POSTS	1		2,415.60
INV 0000951627/11/2019		PERTH SAFETY PRODUCTS PTY LTD	ROAD SIGN BLADE - 'MURESK ROAD'	1	88.00	
INV 0000952327/11/2019		PERTH SAFETY PRODUCTS PTY LTD	3M RHS YELLOW SIGN MOUNTING POSTS	1	1,980.00	
INV 0000952728/11/2019		PERTH SAFETY PRODUCTS PTY LTD	ROAD SIGNS 'GOOCH ROAD' BLADES	1	220.00	
INV 0000953705/12/2019		PERTH SAFETY PRODUCTS PTY LTD	T Junction Sign - W2-3B	1	127.60	
EFT35322	20/12/2019	PEF FOOD SERVICES PTY LTD	STOCK PURCHASES FOR NORTHAM SWIMMING POOL.	1		2,446.00
INV KS265790/12/2019		PEF FOOD SERVICES PTY LTD	STOCK PURCHASES FOR NORTHAM SWIMMING POOL.	1	2,446.00	
EFT35323	20/12/2019	EJ & DE ROBINSON	REPLACE GUTTER STRAPS THAT HAD FALLEN OUT	1		143.00
INV 000086/1901/12/2019		EJ & DE ROBINSON	REPLACE GUTTER STRAPS THAT HAD FALLEN OUT	1	143.00	
EFT35324	20/12/2019	POWER MUSIC PTY LTD	CHRISTMAS ON FITZGERALD 2019: STAGE, SOUND AND LIGHTING	1		4,180.00
INV INV-132817/12/2019		POWER MUSIC PTY LTD	CHRISTMAS ON FITZGERALD 2019: STAGE, SOUND AND LIGHTING	1	4,180.00	

Ordinary Council Meeting Minutes
22 January 2020

Date: 07/01/2020
Time: 8:12:43AM

Shire of Northam

USER: Kathy Scholz
PAGE: 63

Cheque /EFT No	Date	Name	Invoice Description	Bank Code	INV Amount	Amount
EFT35325	20/12/2019	QUBE LOGISTICS	Delivery of Chlorine Gas Canister 950kg	1		1,673.17
INV TS1753231/10/2019		QUBE LOGISTICS	DELIVERY OF 920KG CHLORINE GAS	1	835.86	
INV TS1759822/11/2019		QUBE LOGISTICS	Delivery of Chlorine Gas Canister 950kg	1	837.31	
EFT35326	20/12/2019	RETAIL DECISIONS (COLES)	COLES PURCHASES FOR STAFF - NOVEMBER 2019.	1		2,764.95
INV NOVEMBER 0/11/2019		RETAIL DECISIONS (COLES)	COLES PURCHASES FOR STAFF - NOVEMBER 2019.	1	2,764.95	
EFT35327	20/12/2019	SANTALEUCA FORRESTRY	BOX OF 10 NOUGAT 15 IN A BOX	1		462.70
INV 1215	03/12/2019	SANTALEUCA FORRESTRY	BOX OF 10 NOUGAT 15 IN A BOX	1	462.70	
EFT35328	20/12/2019	SOUTHERN CROSS AUSTEREO PTY LTD	I LOVE AVON VALLEY CAMPAIGN 2019/20- BRONZE SPONSOR	1		550.00
INV 7095162730/11/2019		SOUTHERN CROSS AUSTEREO PTY LTD	I LOVE AVON VALLEY CAMPAIGN 2019/20- BRONZE SPONSOR	1	550.00	
EFT35329	20/12/2019	SPECIALISED TREE SERVICE	REMOVAL OF FALLEN BRANCH FROM CORNER OF SELBY ST X GORDON STREET	1		693.00
INV 3211	20/12/2019	SPECIALISED TREE SERVICE	REMOVAL OF FALLEN BRANCH FROM CORNER OF SELBY ST X GORDON STREET	1	693.00	
EFT35330	20/12/2019	SPORTSPOWER NORTHAM	SPORTING EQUIPMENT FOR THE REC CENTRE.	1		164.95
INV 19-0001518/12/2019		SPORTSPOWER NORTHAM	SPORTING EQUIPMENT FOR THE REC CENTRE.	1	164.95	
EFT35331	20/12/2019	STEWART & HEATON CLOTHING CO.PTY LTD	UNIFORMS FOR BFB	1		10,335.76
INV SIN-311004/10/2019		STEWART & HEATON CLOTHING CO.PTY LTD	UNIFORMS FOR BFB	1	4,590.87	
INV SIN-311545/10/2019		STEWART & HEATON CLOTHING CO.PTY LTD	UNIFORMS FOR BFB	1	440.18	
INV SIN-311516/10/2019		STEWART & HEATON CLOTHING CO.PTY LTD	UNIFORMS FOR BFB	1	1,155.46	
INV SIN-312025/10/2019		STEWART & HEATON CLOTHING CO.PTY LTD	UNIFORMS FOR BFB	1	2,515.52	
INV SIN-312028/10/2019		STEWART & HEATON CLOTHING CO.PTY LTD	UNIFORMS FOR BFB	1	159.51	

Ordinary Council Meeting Minutes
22 January 2020



Date: 07/01/2020
Time: 8:12:43AM

Shire of Northam

USER: Kathy Scholz
PAGE: 64

Cheque /EFT No	Date	Name	Invoice Description	Bank Code	INV Amount	Amount
INV SIN-312404/11/2019		STEWART & HEATON CLOTHING CO.PTY LTD	UNIFORMS FOR BFB	1	357.64	
INV SIN-313018/11/2019		STEWART & HEATON CLOTHING CO.PTY LTD	UNIFORMS FOR BFB	1	1,116.58	
EFT35332	20/12/2019	THE PRINT SHOP BUNBURY	A3 AND A4 POSTERS AND DL BROCHURES	1		274.00
INV 24709	22/10/2019	THE PRINT SHOP BUNBURY	A3 AND A4 POSTERS AND DL BROCHURES	1	274.00	
EFT35333	20/12/2019	TREVOR EASTWELL	DRIVING FROM WUNDOWIE TO NORTHAM COMMUNITY BUS - DECEMBER 2019	1		150.00
INV 59	19/12/2019	TREVOR EASTWELL	DRIVING FROM WUNDOWIE TO NORTHAM COMMUNITY BUS - DECEMBER 2019	1	150.00	
EFT35334	20/12/2019	WARRICKS NEWSAGENCY	STATIONERY FOR ADMIN	1		718.70
INV 56375	13/11/2019	WARRICKS NEWSAGENCY	STATIONERY FOR ADMIN	1	676.60	
INV SN0001722/11/2019		WARRICKS NEWSAGENCY	KILLARA - NEWSPAPER COPIES NOVEMBER 2019	1	42.10	
EFT35335	20/12/2019	WESTERN AUSTRALIAN ELECTORAL COMMISSION	2019 LOCAL GOVERNMENT ELECTIONS	1		32,933.49
INV 3171	02/12/2019	WESTERN AUSTRALIAN ELECTORAL COMMISSION	2019 LOCAL GOVERNMENT ELECTIONS	1	32,933.49	
EFT35336	20/12/2019	WESTWIDE AUTO ELECTRICS AND AIR CONDITIONING	PN1207 BEACON NOT WORKING PLUS LEFT HEADLIGHT/ REPLACE GLOBES IF BLOWN QUOTE ON REPLACING BEACON IF REQUIRED AND SERVICE AIR COND AND REPLACE FILTERS	1		4,560.00
INV INV-968620/09/2019		WESTWIDE AUTO ELECTRICS AND AIR CONDITIONING	REPLACE & RE-WIRE TRAILER PLUG ON DRAINAGE CREW TRUCK	1	225.00	
INV INV-968723/09/2019		WESTWIDE AUTO ELECTRICS AND AIR CONDITIONING	UHF RADIO HANDPIECE REPLACE, PN1611	1	480.00	
INV INV-969223/09/2019		WESTWIDE AUTO ELECTRICS AND AIR CONDITIONING	PN1408 TRACTOR AIR COND NEEDS GAS	1	460.00	
INV INV-969323/09/2019		WESTWIDE AUTO ELECTRICS AND AIR CONDITIONING	PN1207 BEACON NOT WORKING PLUS LEFT HEADLIGHT/ REPLACE GLOBES IF BLOWN QUOTE ON REPLACING BEACON IF REQUIRED AND SERVICE AIR COND AND REPLACE FILTERS	1	755.00	

Ordinary Council Meeting Minutes
22 January 2020



Date: 07/01/2020
Time: 8:12:43AM

Shire of Northam

USER: Kathy Scholz
PAGE: 65

Cheque /EFT No	Date	Name	Invoice Description	Bank Code	INV Amount	Amount
INV INV-968823/09/2019		WESTWIDE AUTO ELECTRICS AND AIR CONDITIONING	REPLACE UHF WITH NEW UNIT AND RE-MOUNT MIC HOLDER	1	440.00	
INV INV-969123/09/2019		WESTWIDE AUTO ELECTRICS AND AIR CONDITIONING	LHS BEACON LIGHT BROKEN ON PM1305 REPLACE	1	400.00	
INV INV-969023/09/2019		WESTWIDE AUTO ELECTRICS AND AIR CONDITIONING	INSTALL UHF INTO PM1623 - REGO N11469	1	550.00	
INV INV-968923/09/2019		WESTWIDE AUTO ELECTRICS AND AIR CONDITIONING	PN0001 TRAILER PLUG REPLACE	1	250.00	
INV INV-964419/11/2019		WESTWIDE AUTO ELECTRICS AND AIR CONDITIONING	INVESTIGATE WIRING TO VMB SIGN NOT WORKING AND TRAILER PLUG WIRING.	1	600.00	
INV INV-964319/11/2019		WESTWIDE AUTO ELECTRICS AND AIR CONDITIONING	ON SITE REPAIRS TO TRAFFIC LIGHTS TRAILERS NO WORKING.	1	400.00	
EFT35337	20/12/2019	WHE&TBELT SAFETYWEAR	WORK BOOTS - GLEN MCPHERSON	1		276.00
INV 9128	14/11/2019	WHE&TBELT SAFETYWEAR	BLUE HAD WITH FLAP AT BACK LIGHTWEIGHT	1	126.00	
INV 9161	03/12/2019	WHE&TBELT SAFETYWEAR	WORK BOOTS - GLEN MCPHERSON	1	150.00	
DD14582.1	12/12/2019	BANKWEST	ROSS RAYSON MASTERCARD 24/10/19 TO 21/11/19	1		9,109.10
INV B RUTTE12/12/2019		BANKWEST	BRENDON RUTTER MASTERCARD 24/10/19 TO 21/11/19	1	603.64	
INV C YOUNG12/12/2019		BANKWEST	COLIN YOUNG MASTERCARD 24/10/19 TO 21/11/19	1	1,832.90	
INV C KLEYN12/12/2019		BANKWEST	CLINTON KLEYNHANS MASTERCARD 24/10/19 TO 21/10/19	1	816.90	
INV C HUNT 12/12/2019		BANKWEST	CHAD HUNT MASTERCARD 24/10/19 TO 21/11/19	1	1,946.64	
INVR RAYSC12/12/2019		BANKWEST	ROSS RAYSON MASTERCARD 24/10/19 TO 21/11/19	1	3,909.02	
DD14584.1	10/12/2019	WA SUPER	Payroll deductions	1		27,589.45
INV SUPER 10/12/2019		WA SUPER	Superannuation contributions	1	24,041.73	
INV DEDUCT10/12/2019		WA SUPER	Payroll deductions	1	2,099.73	
INV DEDUCT10/12/2019		WA SUPER	Payroll deductions	1	83.64	
INV DEDUCT10/12/2019		WA SUPER	Payroll deductions	1	30.22	
INV DEDUCT10/12/2019		WA SUPER	Payroll deductions	1	230.76	

Ordinary Council Meeting Minutes
22 January 2020



Date: 07/01/2020
Time: 8:12:43AM

Shire of Northam

USER: Kathy Scholz
PAGE: 66

Cheque /EFT No	Date	Name	Invoice Description	Bank Code	INV Amount	Amount
INV DEDUCT10/12/2019		WA SUPER	Payroll deductions	1	25.00	
INV DEDUCT10/12/2019		WA SUPER	Payroll deductions	1	296.43	
INV DEDUCT10/12/2019		WA SUPER	Payroll deductions	1	584.00	
INV DEDUCT10/12/2019		WA SUPER	Payroll deductions	1	44.01	
INV DEDUCT10/12/2019		WA SUPER	Payroll deductions	1	153.93	
DD14584.2	10/12/2019	ESSENTIAL SUPER	Superannuation contributions	1		159.15
INV SUPER	10/12/2019	ESSENTIAL SUPER	Superannuation contributions	1	159.15	
DD14584.3	10/12/2019	REST INDUSTRY SUPER	Superannuation contributions	1		455.56
INV SUPER	10/12/2019	REST INDUSTRY SUPER	Superannuation contributions	1	455.56	
DD14584.4	10/12/2019	(THE QUEENSLAND LOCAL GOVERNMENT SUPERANNUATION BOARD) LG SUPER	Superannuation contributions	1		316.79
INV SUPER	10/12/2019	(THE QUEENSLAND LOCAL GOVERNMENT SUPERANNUATION BOARD) LG SUPER	Superannuation contributions	1	316.79	
DD14584.5	10/12/2019	PRIME SUPER	Payroll deductions	1		443.36
INV SUPER	10/12/2019	PRIME SUPER	Superannuation contributions	1	319.63	
INV DEDUCT10/12/2019		PRIME SUPER	Payroll deductions	1	123.73	
DD14584.6	10/12/2019	ONEPATH	Superannuation contributions	1		195.87
INV SUPER	10/12/2019	ONEPATH	Superannuation contributions	1	195.87	
DD14584.7	10/12/2019	ASGARD EMPLOYEE SUPERANNUATION	Superannuation contributions	1		50.00
INV SUPER	10/12/2019	ASGARD EMPLOYEE SUPERANNUATION	Superannuation contributions	1	50.00	
DD14584.8	10/12/2019	MEDIA SUPER	Superannuation contributions	1		206.13
INV SUPER	10/12/2019	MEDIA SUPER	Superannuation contributions	1	206.13	
DD14584.9	10/12/2019	UNISUPER	Payroll deductions	1		575.52

Ordinary Council Meeting Minutes
22 January 2020



Date: 07/01/2020
Time: 8:12:43AM

Shire of Northam

USER: Kathy Scholz
PAGE: 67

Cheque /EFT No	Date	Name	Invoice Description	Bank Code	INV Amount	Amount
INV SUPER	10/12/2019	UNISUPER	Superannuation contributions	1	414.91	
INV DEDUCT	10/12/2019	UNISUPER	Payroll deductions	1	160.61	
DD14615.1	24/12/2019	WA SUPER	Payroll deductions	1		29,127.31
INV SUPER	24/12/2019	WA SUPER	Superannuation contributions	1	25,159.58	
INV DEDUCT	24/12/2019	WA SUPER	Payroll deductions	1	2,500.92	
INV DEDUCT	24/12/2019	WA SUPER	Payroll deductions	1	71.93	
INV DEDUCT	24/12/2019	WA SUPER	Payroll deductions	1	29.05	
INV DEDUCT	24/12/2019	WA SUPER	Payroll deductions	1	230.76	
INV DEDUCT	24/12/2019	WA SUPER	Payroll deductions	1	25.00	
INV DEDUCT	24/12/2019	WA SUPER	Payroll deductions	1	584.00	
INV DEDUCT	24/12/2019	WA SUPER	Payroll deductions	1	201.42	
INV DEDUCT	24/12/2019	WA SUPER	Payroll deductions	1	70.35	
INV DEDUCT	24/12/2019	WA SUPER	Payroll deductions	1	163.49	
INV DEDUCT	24/12/2019	WA SUPER	Payroll deductions	1	90.81	
DD14615.2	24/12/2019	ESSENTIAL SUPER	Superannuation contributions	1		162.26
INV SUPER	24/12/2019	ESSENTIAL SUPER	Superannuation contributions	1	162.26	
DD14615.3	24/12/2019	REST INDUSTRY SUPER	Superannuation contributions	1		457.11
INV SUPER	24/12/2019	REST INDUSTRY SUPER	Superannuation contributions	1	457.11	
DD14615.4	24/12/2019	(THE QUEENSLAND LOCAL GOVERNMENT SUPERANNUATION BOARD) LG SUPER	Superannuation contributions	1		316.79
INV SUPER	24/12/2019	(THE QUEENSLAND LOCAL GOVERNMENT SUPERANNUATION BOARD) LG SUPER	Superannuation contributions	1	316.79	
DD14615.5	24/12/2019	PRIME SUPER	Payroll deductions	1		441.65
INV SUPER	24/12/2019	PRIME SUPER	Superannuation contributions	1	318.40	

Ordinary Council Meeting Minutes
22 January 2020



Date: 07/01/2020
Time: 8:12:43AM

Shire of Northam

USER: Kathy Scholz
PAGE: 68

Cheque /EFT No	Date	Name	Invoice Description	Bank Code	INV Amount	Amount
INV DEDUCT	24/12/2019	PRIME SUPER	Payroll deductions	1	123.25	
DD14615.6	24/12/2019	ONEPATH	Superannuation contributions	1		194.10
INV SUPER	24/12/2019	ONEPATH	Superannuation contributions	1	194.10	
DD14615.7	24/12/2019	ASGARD EMPLOYEE SUPERANNUATION	Superannuation contributions	1		50.00
INV SUPER	24/12/2019	ASGARD EMPLOYEE SUPERANNUATION	Superannuation contributions	1	50.00	
DD14615.8	24/12/2019	MEDIA SUPER	Superannuation contributions	1		191.26
INV SUPER	24/12/2019	MEDIA SUPER	Superannuation contributions	1	191.26	
DD14615.9	24/12/2019	UNISUPER	Payroll deductions	1		598.06
INV SUPER	24/12/2019	UNISUPER	Superannuation contributions	1	431.16	
INV DEDUCT	24/12/2019	UNISUPER	Payroll deductions	1	166.90	
DD14624.1	30/12/2019	TENNANT AUSTRALIA	LEASE FEE DECEMBER 2019 CLEANING EQUIPMENT RECREATION CENTRE	1		1,046.85
INV DECEMB	30/12/2019	TENNANT AUSTRALIA	LEASE FEE DECEMBER 2019 CLEANING EQUIPMENT RECREATION CENTRE	1	1,046.85	
DD14584.10	10/12/2019	MLC NOMINEES PTY LTD	Superannuation contributions	1		228.88
INV SUPER	10/12/2019	MLC NOMINEES PTY LTD	Superannuation contributions	1	228.88	
DD14584.11	10/12/2019	HESTA SUPER FUND	Superannuation contributions	1		87.48
INV SUPER	10/12/2019	HESTA SUPER FUND	Superannuation contributions	1	87.48	
DD14584.12	10/12/2019	AUSTRALIAN SUPER PTY LTD	Payroll deductions	1		3,561.07
INV SUPER	10/12/2019	AUSTRALIAN SUPER PTY LTD	Superannuation contributions	1	3,276.06	
INV DEDUCT	10/12/2019	AUSTRALIAN SUPER PTY LTD	Payroll deductions	1	285.01	
DD14584.13	10/12/2019	THE TRUSTEE FOR A. E & DL WILLIAMS SUPER FUND	Superannuation contributions	1		169.52

Ordinary Council Meeting Minutes
22 January 2020



Date: 07/01/2020
Time: 8:12:43AM

Shire of Northam

USER: Kathy Scholz
PAGE: 69

Cheque /EFT No	Date	Name	Invoice Description	Bank Code	INV Amount	Amount
INV SUPER	10/12/2019	THE TRUSTEE FOR A. E & DL WILLIAMS SUPER FUND	Superannuation contributions	1	169.52	
DD14584.14	10/12/2019	CBUS	Payroll deductions	1		517.93
INV SUPER	10/12/2019	CBUS	Superannuation contributions	1	373.39	
INV DEDUCT	10/12/2019	CBUS	Payroll deductions	1	144.54	
DD14584.15	10/12/2019	ZURICH AUSTRALIA LIMITED	Payroll deductions	1		598.75
INV SUPER	10/12/2019	ZURICH AUSTRALIA LIMITED	Superannuation contributions	1	431.66	
INV DEDUCT	10/12/2019	ZURICH AUSTRALIA LIMITED	Payroll deductions	1	167.09	
DD14584.16	10/12/2019	IOOF PORTFOLIO SERVICE SUPERANNUATION FUND	Superannuation contributions	1		211.64
INV SUPER	10/12/2019	IOOF PORTFOLIO SERVICE SUPERANNUATION FUND	Superannuation contributions	1	211.64	
DD14584.17	10/12/2019	AMP LIFE LIMITED	Superannuation contributions	1		739.80
INV SUPER	10/12/2019	AMP LIFE LIMITED	Superannuation contributions	1	739.80	
DD14584.18	10/12/2019	NETWEALTH SUPERANNUATION	Superannuation contributions	1		269.04
INV SUPER	10/12/2019	NETWEALTH SUPERANNUATION	Superannuation contributions	1	269.04	
DD14584.19	10/12/2019	HOSTPLUS SUPER	Superannuation contributions	1		550.77
INV SUPER	10/12/2019	HOSTPLUS SUPER	Superannuation contributions	1	550.77	
DD14584.20	10/12/2019	SUNSUPER	Superannuation contributions	1		701.60
INV SUPER	10/12/2019	SUNSUPER	Superannuation contributions	1	701.60	
DD14584.21	10/12/2019	MACQUARIE SUPER MANAGER	Superannuation contributions	1		139.11
INV SUPER	10/12/2019	MACQUARIE SUPER MANAGER	Superannuation contributions	1	139.11	
DD14615.10	24/12/2019	CATHOLIC SUPER	Superannuation contributions	1		56.09
INV SUPER	24/12/2019	CATHOLIC SUPER	Superannuation contributions	1	56.09	

Ordinary Council Meeting Minutes
22 January 2020



Date: 07/01/2020
Time: 8:12:43AM

Shire of Northam

USER: Kathy Scholz
PAGE: 70

Cheque /EFT No	Date	Name	Invoice Description	Bank Code	INV Amount	Amount
DD14615.11	24/12/2019	MLC NOMINEES PTY LTD	Superannuation contributions	1		268.94
INV SUPER	24/12/2019	MLC NOMINEES PTY LTD	Superannuation contributions	1	268.94	
DD14615.12	24/12/2019	AUSTRALIAN SUPER PTY LTD	Payroll deductions	1		3,547.59
INV SUPER	24/12/2019	AUSTRALIAN SUPER PTY LTD	Superannuation contributions	1	3,255.53	
INV DEDUCT	24/12/2019	AUSTRALIAN SUPER PTY LTD	Payroll deductions	1	292.06	
DD14615.13	24/12/2019	HESTA SUPER FUND	Superannuation contributions	1		17.04
INV SUPER	24/12/2019	HESTA SUPER FUND	Superannuation contributions	1	17.04	
DD14615.14	24/12/2019	THE TRUSTEE FOR A. E & DL WILLIAMS SUPER FUND	Superannuation contributions	1		126.36
INV SUPER	24/12/2019	THE TRUSTEE FOR A. E & DL WILLIAMS SUPER FUND	Superannuation contributions	1	126.36	
DD14615.15	24/12/2019	CBUS	Payroll deductions	1		517.93
INV SUPER	24/12/2019	CBUS	Superannuation contributions	1	373.39	
INV DEDUCT	24/12/2019	CBUS	Payroll deductions	1	144.54	
DD14615.16	24/12/2019	AUSTRALIAN ETHICAL SUPER	Superannuation contributions	1		80.95
INV SUPER	24/12/2019	AUSTRALIAN ETHICAL SUPER	Superannuation contributions	1	80.95	
DD14615.17	24/12/2019	ZURICH AUSTRALIA LIMITED	Payroll deductions	1		598.75
INV SUPER	24/12/2019	ZURICH AUSTRALIA LIMITED	Superannuation contributions	1	431.66	
INV DEDUCT	24/12/2019	ZURICH AUSTRALIA LIMITED	Payroll deductions	1	167.09	
DD14615.18	24/12/2019	IOOF PORTFOLIO SERVICE SUPERANNUATION FUND	Superannuation contributions	1		194.31
INV SUPER	24/12/2019	IOOF PORTFOLIO SERVICE SUPERANNUATION FUND	Superannuation contributions	1	194.31	
DD14615.19	24/12/2019	AMP LIFE LIMITED	Superannuation contributions	1		739.61

Date: 07/01/2020
 Time: 8:12:43AM

Shire of Northam

USER: Kathy Scholz
 PAGE: 71

Cheque /EFT No	Date	Name	Invoice Description	Bank Code	INV Amount	Amount
INV SUPER	24/12/2019	AMP LIFE LIMITED	Superannuation contributions	1	739.61	
DD14615.20	24/12/2019	NETWEALTH SUPERANNUATION	Superannuation contributions	1		269.04
INV SUPER	24/12/2019	NETWEALTH SUPERANNUATION	Superannuation contributions	1	269.04	
DD14615.21	24/12/2019	HSTPLUS SUPER	Superannuation contributions	1		564.50
INV SUPER	24/12/2019	HSTPLUS SUPER	Superannuation contributions	1	564.50	
DD14615.22	24/12/2019	SUNSUPER	Superannuation contributions	1		709.57
INV SUPER	24/12/2019	SUNSUPER	Superannuation contributions	1	709.57	
DD14615.23	24/12/2019	MACQUARIE SUPER MANAGER	Superannuation contributions	1		142.30
INV SUPER	24/12/2019	MACQUARIE SUPER MANAGER	Superannuation contributions	1	142.30	

REPORT TOTALS

Bank Code	Bank Name	TOTAL
1	MUNI FUND	2,658,411.03
TOTAL		2,658,411.03

Attachment 2

Payment dates 1 December 2019 to 31 December 2019

- Municipal Fund payment cheque numbers 35239 to 35259 Total \$135,279.49.

Electronic Funds Transfer

- Municipal Fund EFT34994 to EFT35337 Total \$2,435,836.65.

Direct Debits Total \$87,294.89

All have been made in accordance with delegated authority reference number (M/F/F/Regs LGA 1995 S5.42).

Month	Cheques	EFT Payments	Direct Debits	Payroll	Total Payments
	2019/2020	2019/2020	2019/2020	2019/2020	2019/2020
July	\$ 206,266.12	\$ 3,308,502.03	\$ 76,110.78	\$ 432,960.90	\$ 4,023,839.83
August	\$ 49,915.44	\$ 2,828,610.12	\$ 79,487.55	\$ 455,717.69	\$ 3,413,730.80
September	\$ 55,440.41	\$ 2,948,297.32	\$ 72,450.07	\$ 429,744.94	\$ 3,505,932.74
October	\$ 100,301.16	\$ 3,153,464.10	\$ 116,698.02	\$ 651,629.55	\$ 4,022,092.83
November	\$ 60,595.68	\$ 3,143,308.87	\$ 78,728.94	\$ 470,325.55	\$ 3,752,959.04
December	\$ 135,279.49	\$ 2,435,836.65	\$ 87,294.89	\$ 495,027.66	\$ 3,153,438.69
January					\$ -
February					\$ -
March					\$ -
April					\$ -
May					\$ -
June					\$ -
Total	\$607,798.30	\$17,818,019.09	\$510,770.25	\$2,935,406.29	\$21,871,993.93

The Following table presents all payments made for the month from Council credit cards paid by direct debit DD14582.1

Summary Credit Card Payments	\$	Total
Executive Manager Engineering Services		
SHIRE OF NORTHAM - CHANGE OF PLATE	27.70	
DEPARTMENT OF HEALTH - ADD NEW POOL TO EXISTING CHLORINE PERMIT	82.00	
DEPARTMENT OF MINES - ANNUAL LICENCE PAYMENT - LOT 28055 COLEBATCH ROAD SEWERAGE EFFLUENT TREATMENT PLANT	223.00	
MALL MANAGERS WA PTY - CASUAL MALL LEASING	167.15	
SHIRE OF NORTHAM - LICENCE OF NEW RANGE UTE	290.00	
SHIRE OF NORTHAM - LICENCE OF NEW RANGE UTE - GST FREE	27.05	816.90

CESM		
FRESH TRADING CO FOODS - REFRESHMENTS MT OMMANEY FIRE	338.30	
MCDONALDS NORTHAM - REFRESHMENTS FOR VOLENTEERS OF A PRESCRIBED BURN	120.55	
GOOGLE PLAY - CALL FORWARD APP FOR LM PHONE	3.59	
FRESH TRADING CO FOODS - BFW WORKSHOP CATERING	69.10	
FRESH TRADING CO FOODS GST FREE - BFW WORKSHOP CATERING	10.20	
COLES NORTHAM - VOLUNTEER L1 WELFARE FOR INCIDENTS	61.90	603.64
Executive Manager Corporate Services		
AMAYSIM - MONTHLY FEES - MOBILE SUPPORT LIBRARY	10.00	
OFFICEWORKS - APPLE PENCIL FOR SHIRE PRESIDENT	295.95	
EBAY - BATTERY FOR RANGERS BODY CAMMERA	11.51	
THE VILLE - ACCOMMODATION FOR TOWNSVILLE CONFERENCE MICHELLE BLACKHURST	875.48	
FOXIT SOFTWARE - FOXIT SOFTWARE LICENCE	283.00	
MICROSOFT MONTHLY FEES OFFICE 365 BUSINESS	47.19	
ADOBE CREATIVE CLOUD - MONTHLY FEES	213.99	
FOREIGN TRANSACTION FEE	95.78	1,832.90
Executive Manager Development Services		
BALCONY RESTAURANT (TOWNSVILLE) - BREAKFAST FOR TOWNSVILLE CONFERENCE	78.90	
ZIZIGO KOREAN CUSINE (TOWNSVILLE) - DINNER FOR TOWNSVILLE CONFERENCE	69.00	
PERTH AIRPORT - PARKING FOR TOWNSVILLE CONFERENCE	107.70	
THE VILLE RESORT CASINO (TOWNSVILLE) - ACCOMMODATION FOR TOWNSVILLE CONFERENCE CHADD HUNT	895.79	
PHAPS PTY LTD - THE DUKES INN - BUSH FIRE BRIGADE MEETING REFRESHMENTS	178.50	
FRESH TRADING CO OPS - 16.75L ADBLUE	16.75	
SOFTWARE MART AUSTRALIA - USER LICENCE FOR MICROSOFT PROJECT 2016 PRO	300.00	
AUSTRALIAN INSTITUTE - SEMINAR NATIONAL CONSTRUCTION CODE - SENIOR BUILDING SURVEYOR GORDON TESTER	300.00	1,946.64
Executive Manager Community Services		
THE VILLE RESORT CASINO - ACCOMODATION FOR TOWNSVILLE CONFERENCE ROSS RAYSON	860.00	
CABCHARGE (TOWNSVILE) - CAB FROM AIRPORT TO HOTEL	27.30	
FACEBOOK - READY SET GO CAMPAIGN BOOST	1375.00	
THE VILLE QUARTERDECK (TOWNSVILLE) - DINNER FOR TOWNSVILLE CONFERENCE	33.00	
THE VILLE THE PALM HOUSE (TOWNSVILLE) - BREAKFAST FOR TOWNSVILLE CONFERENCE	34.45	
FACEBOOK - READY SET GO CAMPAIGN BOOST	1375.00	
TOWNSVILLE BREWING (TOWNSVILLE) - DINNER FOR TOWNSVILLE CONFERENCE	70.00	
CABCHARGE (TOWNSVILE) - CAB FROM RESTAURANT TO GARBUIT	26.57	
PERTH AIRPORT - PARKING FOR TOWNSVILLE CONFERENCE	107.70	3,909.02
Total Credit Card Expenditure		\$9,109.10

CERTIFICATION OF THE PRESIDENT

I hereby certify that this schedule of account covering vouchers and electronic fund transfer payments as per above and totalling \$3,153,438.69 was submitted to the Ordinary Meeting of Council on Wednesday, 22 January 2020.

_____ CERTIFICATION OF THE PRESIDENT

CERTIFICATE OF THE CHIEF EXECUTIVE OFFICER

This schedule of accounts paid covering vouchers \$3,153,438.69 was submitted to each member of the Council on Wednesday, 22 January 2020, has been checked and is fully supported by vouchers and invoices which are submitted herewith and which have been duly certified as to the receipt of goods and the rendition of services and as to prices, computations and casting and the amounts shown are due for payment.

_____ CHIEF EXECUTIVE OFFICER



12.4.2 Financial Statement for the period ending 31 December 2019

Address:	N/A
Owner:	N/A
Applicant:	N/A
File Reference:	2.1.3.4
Reporting Officer:	Zoe Macdonald, Accountant
Responsible Officer:	Colin Young, Executive Manager Corporate Services
Officer Declaration of Interest:	Nil
Voting Requirement:	Simple Majority
Press release to be issued:	No

BRIEF

For Council to receive the Financial Statement for the period ending 31 December 2019.

ATTACHMENTS

Attachment 1: Financial Statement for the period ending 31 December 2019.

A. BACKGROUND / DETAILS

The reporting of monthly financial information is a requirement under section 6.4 of the Local Government Act 1995, and Regulation 34 of the Local Government (Financial Management) Regulations.

The Statement of Financial Activity for the period ending 31 December 2019 is included as Attachment 1 to this Agenda and includes the following reports:

- Statement of Financial Activity;
- Operating Statements;
- Balance Sheet;
- Acquisition of Assets;
- Disposal of Assets;
- Information on Borrowings;
- Reserves;
- Net Current Assets;
- Rating Information

The report includes a summary of the financial position along with comments relating to the statements. If Councillors wish to discuss the report contents or any other matters relating to this please contact Council Finance staff prior to the meeting, **new items this month are in bold.**

Notes to the Financial Statements

Operating Income

1. **Governance is over budget by \$34,331. This is due to the additional funds received in the insurance rebate, and the receipt of long service leave contributions from other Shires. The budget adjustments will be made during the budget review process.**
2. Law and Order is under budget by \$66,248 due to the timing of BFBs and SES grant.
3. Education and Welfare is over budget by \$322,158 due to the timing of the receipt of Killara Brokerage Fees of \$68,178 **and CHSP Recurrent Grant Funding of \$264,579. The budget will be amended during budget review process**
4. Community Amenities is over budget by \$22,226 predominantly due to septage fees of \$29,848.
5. Transport is over budget by 2.02% predominantly due to the receipt of unbudgeted funds from extractive industries road maintenance contribution of \$42,525.
6. **Other property and services is \$37,915 over budget predominantly due to additional workers compensation claim reimbursements and additional insurance claim revenue.**

Operating Expenditure

7. Governance is under budget by 11.99% due to the items presented below;
 - Internal allocation is under budget by \$95,229 due to the timing and lower than anticipated costs (non cash)
8. General Purpose Funding is over budget by \$27,324. This is legal costs recoverable of \$38,821 offset by an under budgeted valuations and title searches of \$12,504.
9. **Law and Order are under budget by 4.94%**, fire hazard reduction expenses being \$79,980 under (timing) **offset by CCTV community policing of \$19,767 and brigades expenses of \$23,142 (timing) over budget. The CCTV additional expense will be addressed at the budget review.**
10. **Education and welfare are under budget by \$39,746 predominantly due to salaries and wages of \$42,468**
11. Community Amenities are under budget by \$196,899 The items disclosed below are under budget year to date
 - Rubbish site maintenance \$61,206 under (timing)
 - **Refuse collection is \$17,223**
 - **Green waste management \$35,000**
 - **Septage pond maintenance \$48,922**
 - **Drainage management \$13,004**
 - **Town Planning Consultants \$24,996**

12. Recreation and culture is under budget \$134,468 due predominantly to
- Pools and water parks \$96,813 (timing)
 - **Northam Town Hall \$18,882**
 - **Progress and Community Association \$20,899**
13. Transport is under budget by \$130,638 due to bridge maintenance of \$148,156 (timing).
14. **Other property and services is the timing of internal allocations and expenses for \$44,565 (non cash).**

Operating Income by Nature and Type

15. Operating grants and contributions revenue are over budget by 10% due to the receipt of the CHSP Grant detailed in item 3 above.
16. Fees and charges are over budget by 3% due to the items disclosed in items 3 and 4 above.
17. Other Revenue is over budget \$135,621 predominantly relating to the items disclosed below;
- Long service leave contributions \$19,595
 - Insurance rebate and claims \$44,704
 - Rates legal costs recoverable \$65,749

Operating Expenditure by Nature and Type

18. Materials and contracts are under budget by 18% relating to items 8,11,12 and 13 disclosed above
19. Utility charges are under budget \$56,385 (timing).
20. Depreciation is over budget predominantly relating to the Newcastle Road bridge.
21. Other Expenditure is under budget 25% due to the timing of internal allocations, (non-cash)

Non Operating Grants Income

22. Non operating grants are over budget by \$144,968 predominantly due to the timing of State grant receipts for Transport

Loss on Asset Disposals

23. The unbudgeted loss on the Hino water truck of \$58,474 will be adjusted at budget review. This transaction was expected to occur in the 18/19 financial year.

Capital Expenditure

24. **Spencers Brook Road SLK 5400 -7360 is over budget by \$168,702 due to additional Shire labour and overheads costs predominantly due to delays in contracts works being carried out. This will be addressed at the budget review**

B. CONSIDERATIONS

B.1 Strategic Community / Corporate Business Plan

Theme Area 6: Governance & Leadership.

Outcome 6.3: The Shire of Northam Council is a sustainable, responsive, innovative and transparent organisation.

B.2 Financial / Resource Implications

The Financial Statements have been prepared in accordance with Council's 2019/20 Budget.

B.3 Legislative Compliance

Section 6.4 and 6.26(2)(g) of the Local Government Act.

Local Government (Financial Management) Regulations 1996.

B.4 Policy Implications

Nil.

B.5 Stakeholder Engagement / Consultation

N/A.

B.6 Risk Implications

Risk Category	Description	Rating (consequence x likelihood)	Mitigation Action
Financial	N/A	N/A	N/A
Health & Safety	N/A	N/A	N/A
Reputation	N/A	N/A	N/A
Service Interruption	N/A	N/A	N/A
Compliance	The Report is to be presented to Council each month in order to comply with relevant legislation	Low (3)	There are processes in place to ensure compliance with relevant legislation
Property	N/A	N/A	N/A
Environment	N/A	N/A	N/A

C. OFFICER'S COMMENT

Nil.

RECOMMENDATION / COUNCIL DECISION

Minute No: C.3864

Moved: Cr Pollard

Seconded: Cr Williams

That Council receive the Financial Statements, prepared in accordance with the Local Government (Financial Management) Regulations, for the period ending 31 December 2019.

CARRIED 10/0

Attachment 1



Shire of Northam

SHIRE OF NORTHAM
MONTHLY STATEMENT OF FINANCIAL ACTIVITY
FOR THE PERIOD ENDING 31 DECEMBER 2019

TABLE OF CONTENTS

	Page
Statement of Financial Activity	2 to 4
Notes to and Forming Part of the Statement	
1 Acquisition of Assets	5 to 8
2 Disposal of Assets	9 to 10
3 Information on Borrowings	11
4 Reserves	12
5 Net Current Assets	13
6 Rating Information	14



SHIRE OF NORTHAM
STATEMENT OF FINANCIAL ACTIVITY
FOR THE PERIOD ENDING 31 DECEMBER 2019

	NOTE	19/20 Budget \$	Ytd Budget \$	19/20 Ytd Actual \$	Variances Actuals to Budget \$	Variances Actuals to Budget %
Operating						
Revenues						
Governance	1	48,600	44,280	78,611	34,331	77.53%
General Purpose Funding Other		2,265,384	1,141,317	1,144,095	2,778	0.24%
General Purpose Funding Rates		10,417,484	10,388,127	10,383,810	(4,317)	(0.04%)
Law, Order, Public Safety	2	1,939,333	569,788	503,540	(66,248)	(11.63%)
Health		61,000	42,620	30,243	(12,377)	(29.04%)
Education and Welfare	3	1,176,072	587,693	909,851	322,158	54.82%
Housing		£2,277	31,134	27,349	(3,785)	(12.16%)
Community Amenities	4	2,704,576	2,047,570	2,069,796	22,226	1.09%
Recreation and Culture		2,694,010	1,428,029	1,414,696	(13,333)	(0.93%)
Transport	5	3,496,860	1,380,191	1,408,076	27,885	2.02%
Economic Services		598,150	263,608	261,348	(2,260)	(0.86%)
Other Property and Services	6	160,200	£2,142	90,057	37,915	72.71%
Total Operating Revenue		25,623,946	17,976,499	18,321,471	344,972	1.92%
Expenses						
Governance	7	(1,369,648)	(764,000)	(672,425)	91,575	11.99%
General Purpose Funding	8	(289,104)	(171,647)	(198,971)	(27,324)	(15.92%)
Law, Order, Public Safety	9	(1,503,081)	(788,735)	(749,795)	38,940	4.94%
Health		(322,270)	(164,200)	(161,363)	2,837	1.73%
Education and Welfare		(1,419,060)	(708,977)	(669,231)	39,746	5.61%
Housing		(75,223)	(37,227)	(31,552)	5,675	15.24%
Community Amenities	10	(3,683,616)	(1,650,249)	(1,453,350)	196,899	11.93%
Recreation & Culture	11	(5,689,382)	(3,354,904)	(3,220,436)	134,468	4.01%
Transport	12	(5,600,097)	(3,085,234)	(2,954,596)	130,638	4.23%
Economic Services	13	(2,570,843)	(1,356,711)	(1,354,393)	2,318	0.17%
Other Property and Services	14	(47,607)	(55,660)	(100,225)	(44,565)	(80.07%)
Total Operating Expenses		(22,569,931)	(12,137,544)	(11,566,338)	571,205	4.71%
Removal of Non-Cash Items						
(Profit)/Loss on Asset Disposals		881,489	1,190,620	1,138,816	(51,804)	
Movement in Employee Benefit Provisions		(22,339)	0	0	0	
Depreciation on Assets		4,156,954	2,078,394	2,229,726	151,332	
Non Operating Items						
Purchase Land and Buildings		(2,507,264)	(562,086)	(136,927)	425,159	
Purchase Plant and Equipment		(1,546,138)	(807,973)	(91,070)	716,903	
Purchase Furniture and Equipment		(61,286)	(42,276)	(11,469)	30,807	
Purchase Infrastructure Assets - Roads		(3,769,439)	(2,795,477)	(1,036,388)	1,759,089	
Purchase Infrastructure Assets - Footpaths		(259,140)	(152,240)	(197)	152,043	
Purchase Infrastructure Assets - Drainage		(1,913,159)	(1,138,980)	(825,785)	313,195	
Purchase Infrastructure Assets - Parks & Ovals		(1,016,732)	(190,132)	(475,575)	(285,443)	
Purchase Infrastructure Assets - Airfields		(193,600)	(96,798)	0	96,798	
Purchase Infrastructure Assets - Streetscape		(175,000)	(82,500)	(97,184)	(14,684)	
Purchase Infrastructure Assets - Other		(7,651,207)	(6,637,664)	(6,352,681)	284,983	
Proceeds from Disposal of Assets		1,901,700	1,079,634	1,079,634	(0)	
Repayment of Debentures		(345,853)	(118,835)	(118,835)	0	
Proceeds from New Debentures		4,500,000	4,500,000	4,500,000	0	
Self-Supporting Loan Principal Income		22,812	12,946	12,946	0	
Transfers to Restricted Assets (Reserves)		(2,497,936)	(246,216)	(246,216)	0	
Transfers from Restricted Asset (Reserves)		2,978,239	798,527	798,527	0	
Transfers from Restricted Asset (Other)		0	0	0	0	#DIV/0!
ADD Net Current Assets July 1 B/Fwd		4,463,884	4,463,884	4,178,315	(285,569)	
LESS Net Current Assets Year to Date		0	7,091,783	11,517,374	4,425,591	
Surplus/Deficit		0	0	(321,129)	(321,130)	

This statement is to be read in conjunction with the accompanying notes.

SHIRE OF NORTHAM

NOTES TO AND FORMING PART OF THE STATEMENT OF FINANCIAL ACTIVITY

FOR THE PERIOD ENDING 31 DECEMBER 2019

1. OPERATING STATEMENT

	Note	19/20 Budget \$	Ytd Budget	19/20 Ytd Actual \$	Variance Actuals to Budget \$	Variance Actual to Budget %
OPERATING REVENUES						
Rates		10,417,484	10,388,127	10,383,810	(4,317)	0%
Operating Grants Subsidies and Contributions	15	4,592,711	2,183,786	2,410,183	226,397	10%
Fees and Charges	16	3,848,003	2,658,891	2,742,277	83,386	3%
Interest Earnings		372,500	172,866	159,879	(12,987)	-8%
Other Revenue	17	863,179	408,488	544,109	135,621	33%
TOTAL OPERATING REVENUE		20,093,877	15,812,158	16,240,258	428,100	3%
OPERATING EXPENSES						
Employee Costs		(8,363,699)	(4,335,569)	(4,338,500)	(2,931)	0%
Materials and Contracts	18	(7,014,040)	(3,417,086)	(2,785,678)	631,408	18%
Utility Charges	19	(1,000,558)	(407,494)	(351,109)	56,385	14%
Depreciation of Non Current Assets	20	(4,156,954)	(2,078,394)	(2,229,726)	(151,332)	-7%
Interest Expenses		(199,187)	(57,487)	(35,278)	22,209	39%
Insurance Expenses		(516,245)	(511,322)	(512,594)	(1,272)	0%
Other Expenditure	21	(121,759)	(139,572)	(174,638)	(35,066)	-25%
TOTAL OPERATING EXPENSE		(21,372,442)	(10,946,924)	(10,427,523)	519,401	-5%
Non Operating Grants Subsidies and Contributions	22	5,214,069	1,936,245	2,081,213	144,968	-7%
Profit on Asset Disposals		318,000	0	0	0	0%
Loss on Asset Disposals	23	(1,199,489)	(1,190,620)	(1,138,816)	51,804	4%
RESULTING FROM OPERATIONS		3,054,015	5,610,859	6,755,132	1,144,273	20%

SHIRE OF NORTHAM

NOTES TO AND FORMING PART OF THE STATEMENT OF FINANCIAL ACTIVITY

FOR THE PERIOD ENDING 31 DECEMBER 2019

2. BALANCE SHEET

	19/20 YTD Actual \$	18/19 Actual \$
CURRENT ASSETS		
Cash Assets	9,489,736	8,123,774
Receivables	7,087,360	5,258,217
Inventories	0	0
TOTAL CURRENT ASSETS	<u>16,577,096</u>	<u>13,381,991</u>
NON-CURRENT ASSETS		
Receivables	554,832	403,701
Land and Buildings	50,807,422	53,117,799
Property, Plant and Equipment	6,896,819	6,935,417
Infrastructure	167,393,698	160,465,459
Financial Assets	210,205	360,723
TOTAL NON-CURRENT ASSETS	<u>225,862,976</u>	<u>221,283,099</u>
TOTAL ASSETS	<u>242,440,072</u>	<u>234,665,090</u>
CURRENT LIABILITIES		
Payables	814,987	3,658,158
Interest-bearing Liabilities	138,726	279,985
Provisions	1,207,425	1,207,425
TOTAL CURRENT LIABILITIES	<u>2,161,138</u>	<u>5,145,568</u>
NON-CURRENT LIABILITIES		
Interest-bearing Liabilities	6,500,696	2,000,696
Provisions	222,810	222,810
Payables	0	221,047
TOTAL NON-CURRENT LIABILITIES	<u>6,723,506</u>	<u>2,444,553</u>
TOTAL LIABILITIES	<u>8,884,644</u>	<u>7,590,121</u>
NET ASSETS	<u>233,555,428</u>	<u>227,074,969</u>
EQUITY		
Retained Surplus	115,112,840	108,080,070
Reserves - Cash Backed	4,463,576	5,015,888
Reserves - Asset Revaluation	113,979,012	113,979,011
TOTAL EQUITY	<u>233,555,428</u>	<u>227,074,969</u>



SHIRE OF NORTHAM

NOTES TO AND FORMING PART OF THE STATEMENT OF FINANCIAL ACTIVITY

FOR THE PERIOD ENDING 31 DECEMBER 2019

3. ACQUISITION OF ASSETS	19/20 Budget \$	19/20 Ytd Actual \$
The following assets have been acquired during the period under review:		
By Program		
Governance		
	Note	
Admin Building	697,500	4,776
Admin Building Solar	19,010	0
CEO Vehicle	58,000	0
New Telephone System	42,276	11,469
Law, Order & Public Safety		
Rangers Ute	56,220	48,821
3.4 Urban Fire Appliance	470,491	0
Irish Town Light Tanker	169,800	0
Clackline Kitchen, Unisex Toilet & Meeting Room	82,055	0
Bakers Hill Fire Shed	413,350	0
LED Fire Danger Rating Signs	39,450	0
Automated Weather Station	8,149	0
Water Tank Smith Road	9,800	0
CCTV Wundowie	257,166	0
SES Building Replace Sliding Door	30,320	0
Health		
Manager Health Vehicle	35,000	0
Education & Welfare		
Solar, Killara	11,300	0
Structural Repairs Memorial Hall	20,000	0
Community Amenities		
Design of Recycling Station Inkpen	40,000	9,940
Old Quarry Drainage	100,000	8,348
Rehab Investigation Old Tip Site	35,000	0
Wind Blown Waste Fence Old Quarry	25,000	0
Transfer Station Tip Shop	576,850	0
King Creek Drainage	7,150	0
Area Drainage	128,669	80,664
Planners Vehicle	35,000	0
Minson Avenue Streetscape	165,000	89,355
CBD Streetscape	0	7,829
Duracote Doors Bernard Park	5,100	0
Recoat Floor Bernard Park	16,385	0

SHIRE OF NORTHAM

NOTES TO AND FORMING PART OF THE STATEMENT OF FINANCIAL ACTIVITY

FOR THE PERIOD ENDING 31 DECEMBER 2019

3. ACQUISITION OF ASSETS (Continued)	Note	19/20 Budget \$	19/20 Ytd Actual \$
<u>By Program (Continued)</u>			
Recreation & Culture			
Wundowie Hall, Solar, Replace Ceiling, Toilet		19,950	0
Southern Brook Hall, New Ceiling, A/C to Kitchen		6,700	2,526
Northam Hall, New Curtain & Track		10,000	4,128
Wundowie Pool Solar		30,360	0
Wundowie Pool Bowl Repainting		10,000	0
Northam Aquatic Facility		6,961,942	6,334,394
Bert Hawke Pavilion - Upgrade, Including Kitchen C/fwd		40,000	0
Rec Centre, Roller Shutters & Remark Floor, CCTV		80,760	26,081
Solar Recreation Centre		38,130	0
Jubilee Oval Upgrade Electric Boards		40,750	0
Community Plan Implementation		90,000	0
Bert Hawke - Drainage C/fwd		40,000	0
Bert Hawke - Lighting C/fwd		20,000	4,097
POS Playground Improvements		122,920	14,572
Northam Youth Space		210,859	30,972
Northam Youth Space Programed Maintenance		26,500	1,031
Artificial Hockey Turf		414,453	424,904
Bridge Crossing Fixings C/fwd		10,000	0
St Johns Ambulance Site Improvements		80,000	0
Wundowie Family Space		50,000	0
Southern Brook Hall Nature Playground		42,000	0
General Library Upgrades, DAP, Paint interior, Solar, CCTV		121,054	81,796
AVVVA - Drainage Works		22,850	498
AVVVA - Roof Replacement C/fwd		145,000	0
Old Railway Station, Exit Gates & Ceiling Fans		18,500	0
Transport			
Northam Depot Redesign		10,000	6,400
Install Light and Pole Rear Shed Wundowie		3,500	0
Solar Northam Depot		11,300	0
Fitzgerald Footpath		60,280	0
Hovea Footpath		91,960	0
Balga Footpath		74,950	0
Wattle Crescent		31,950	197
Drainage - Rural Including WANDRRA		1,665,338	745,121
Spencers Brook Road SLK 5400 - 7360	24	142,000	310,702
Spencers Brook Road SLK 8650 - 10250		555,892	301,270
Spencers Brook Road 12000 - 12800		334,623	39,033
Zamia Terrance (0 - 480)		61,835	0
Chidlow Street West (360 - 670)		27,000	0
Coates Road (0 - 1700)		71,400	865
Vivan Street (0-200)		21,939	0

SHIRE OF NORTHAM

NOTES TO AND FORMING PART OF THE STATEMENT OF FINANCIAL ACTIVITY

FOR THE PERIOD ENDING 31 DECEMBER 2019

3. ACQUISITION OF ASSETS (Continued)	Note	19/20 Budget	19/20 Ytd Actual
Transport		\$	\$
Qualup Place (0 - 140)		15,102	0
Boondine Road (0-640)		70,345	0
Katrine Road		66,000	0
Tamma (1100 - 2400)		58,506	0
Chidlow Street West (20 - 300)		51,915	0
Chidlow Street West (1480 - 1950)		33,675	0
Park Lane (0 - 230)		31,548	0
Carlin Road (2740 - 3550)		50,537	82
Carter Street (200 - 410)		67,980	0
Ord Street (0 - 190)		15,310	0
Irishtown Road (0 - 10000)		159,078	1,908
Maintenance Capitalised		100,000	952
Coates Road		135,706	135,226
O'Neill Road		175,092	177,427
Charles Street (510 - 1070)		83,054	3,206
Kennedy Street (320 - 920)		54,563	0
Henty Place (0 - 270)		58,408	0
Martin Street (0 - 300)		70,909	1,806
Southern Brook Road (0 - 3070)		536,382	3,997
Laneway Land Acquisition		32,000	0
Keane Street		22,000	0
Spencers Brook Road (16430 - 19340)		473,164	7,768
Gravel Resheeting		87,000	0
Kerb Renewal		109,238	7,583
Culvert Renewal		84,238	44,565
Kubota F3680 NS Front Mower, Canopy & Catcher		47,100	0
Bobcat Attachment		15,000	0
Volvo BL71 Backhoe		87,141	0
Fuso Canter 4 Tonne Tipper Truck with Hiab Crane		82,701	0
Isuzu MLR 200 Tipper Manual		82,701	0
Dynapac Vibro Ride on Roller		51,372	0
Bobcat Trailer 4500kg		25,000	0
Honda Four Wheel Motor Cycle		23,090	0
Tandem Trailer		15,250	0
Pegasus 200 Verge Mower		15,510	0
Toyota Hilux workmate 2.7l		26,040	0
Mazda BT50T-top		26,041	0
Mitsubishi Outland Diesel 7 Seat		35,000	0
Holden Trail Blazer 7 Seat Diesel		45,000	42,249
Rock Bucket		10,000	0

SHIRE OF NORTHAM

NOTES TO AND FORMING PART OF THE STATEMENT OF FINANCIAL ACTIVITY

FOR THE PERIOD ENDING 31 DECEMBER 2019

3. ACQUISITION OF ASSETS (Continued)	Note	19/20 Budget \$	19/20 Ytd Actual \$
<u>By Program (Continued)</u>			
Transport			
Upgrade Runway		193,600	0
Economic Services			
Solar Visitor Centre		11,300	0
Signage Tower GEH Mitchell Avenue		10,000	0
Clark Street Water Metre		8,950	0
Water Pump Station Upgrade		169,681	0
Bakers Drainage		25,000	0
BKB Building		75,000	10,721
		<u>19,092,963</u>	<u>9,027,277</u>

SHIRE OF NORTHAM

NOTES TO AND FORMING PART OF THE STATEMENT OF FINANCIAL ACTIVITY

FOR THE PERIOD ENDING 31 DECEMBER 2019

3. ACQUISITION OF ASSETS (Continued)	Note	19/20 Budget \$	19/20 Ytd Actual \$
<u>By Class</u>			
Land Held for Resale		0	0
Land and Buildings		2,507,264	136,927
Plant and Equipment		1,546,138	91,070
Furniture and Equipment		61,286	11,469
Bush Fire Equipment		0	0
Playground Equipment		0	0
Infrastructure Assets - Roads		3,769,439	1,036,388
Infrastructure Assets - Footpaths		259,140	197
Infrastructure Assets - Bridges & Culverts		0	0
Infrastructure Assets - Drainage		1,913,157	825,785
Infrastructure Assets - Parks & Ovals		1,016,732	475,575
Infrastructure Assets - Airfields		193,600	0
Infrastructure Assets - Streetscape		175,000	97,184
Infrastructure Assets - Other		7,651,207	6,352,681
		<u>19,092,963</u>	<u>9,027,277</u>



SHIRE OF NORTHAM

NOTES TO AND FORMING PART OF THE STATEMENT OF FINANCIAL ACTIVITY
FOR THE PERIOD ENDING 31 DECEMBER 2019

4. DISPOSALS OF ASSETS

The following assets have been disposed of during the period under review:

By Program	Written Down Value		Sale Proceeds		Profit(Loss)	
	19/20 Budget \$	Ytd Actual \$	19/20 Budget \$	Ytd Actual \$	19/20 Budget \$	Ytd Actual \$
Governance						
CEO Vehicle	37,360	0	30,000	0	(7,360)	0
Law Order & Public Safety						
PN 1514 Rangers Triton Ute	15,162	14,137	12,000	12,727	(3,162)	(1,410)
Health						
Manager Health Vehicle	19,015	0	15,000	0	(4,015)	0
Killarra Commuter Bus C/fwd					0	0
Community Amenities						
Manager Planning	20,176	0	17,000	0	(3,176)	0
Recreation & Culture						
Victoria Street Oval	2,046,800	2,046,800	969,000	969,000	(1,077,800)	(1,077,800)
Sale of Land, Yilgarn Ave	406,500	0	724,500	0	318,000	0
Transport						
Kubota F3680 NS Front Mower, Canopy & Catcher	12,823	0	7,000	0	(5,823)	0
Bobcat Attachment	3,000	0	3,000	0	0	0
Volvo BL71 Backhoe	75,068	0	17,000	0	(58,068)	0
Fuso Canter 4 Tonne Tipper Truck with Hiab Crane	30,342	0	22,000	0	(8,342)	0
Isuzu MLR 200 Tipper Manual	33,333	0	20,000	0	(13,333)	0
Dynapac Vibro Ride on Roller	3,402	0	2,000	0	(1,402)	0
Bobcat Trailer 4500kg	6,157	0	1,000	0	(5,157)	0
Honda Four Wheel Motor Cycle	1,790	0	200	0	(1,590)	0
Toyota Hilux workmate 2.7l	11,219	0	11,000	0	(219)	0
Mazda BT50T-top	14,230	0	9,000	0	(5,230)	0
Mitsubishi Outland Diesel 7 Seat	21,221	0	18,000	0	(3,221)	0
Hino Water Truck PN1501	0	132,290	0	73,816	0	(58,474)
Holden Trail Blazer 7 Seat Diesel	25,591	25,223	24,000	24,091	(1,591)	(1,132)
	2,783,189	2,218,450	1,901,700	1,079,634	(881,489)	(1,138,816)



SHIRE OF NORTHAM

NOTES TO AND FORMING PART OF THE STATEMENT OF FINANCIAL ACTIVITY
FOR THE PERIOD ENDING 31 DECEMBER 2019

4. DISPOSALS OF ASSETS

The following assets have been disposed of during the period under review:

By Class	Written Down Value		Sale Proceeds		Profit(Loss)	
	19/20 Budget \$	Ytd Actual \$	19/20 Budget \$	Ytd Actual \$	19/20 Budget \$	Ytd Actual \$
Plant & Equipment						
CEO Vehicle	37,360	0	30,000	0	(7,360)	0
PN1514 Rangers Triton Ute 4*4	15,162	14,137	12,000	12,727	(3,162)	(1,410)
Manager Health Vehicle	19,015	0	15,000	0	(4,015)	0
Manager Planning	20,176	0	17,000	0	(3,176)	0
Kubota F3680 NS Front Mower, Canopy & Catche	12,823	0	7,000	0	(5,823)	0
Bobcat Attachment	3,000	0	3,000	0	0	0
Volvo BL71 Backhoe	75,068	0	17,000	0	(58,068)	0
Fuso Canter 4 Tonne Tipper Truck with Hiab Cran	30,342	0	22,000	0	(8,342)	0
Isuzu MLR 200 Tipper Manual	33,333	0	20,000	0	(13,333)	0
Dynapac Vibro Ride on Roller	3,402	0	2,000	0	(1,402)	0
Bobcat Trailer 4500kg	6,157	0	1,000	0	(5,157)	0
Honda Four Wheel Motor Cycle	1,790	0	200	0	(1,590)	0
Toyota Hilux workmate 2.7l	11,219	0	11,000	0	(219)	0
Mazda BT50T-top	14,230	0	9,000	0	(5,230)	0
Mitsubishi Outland Diesel 7 Seat	21,221	0	18,000	0	(3,221)	0
Hino Water Truck PN1501	0	132,290	0	73,816	0	(58,474)
Holden Trail Blazer 7 Seat Diesel	25,591	25,223	24,000	24,091	(1,591)	(1,132)
Land						
Sale of Land, Yilgarn Ave	406,500	0	724,500	0	318,000	0
Victoria Street Oval	2,046,800	2,046,800	969,000	969,000	(1,077,800)	(1,077,800)
	2,783,189	2,218,450	1,901,700	1,079,634	(881,489)	(1,138,816)
					19/20 Budget \$	Ytd Actual \$
Summary					318,000	0
Profit on Asset Disposals					(1,199,489)	(1,138,816)
Loss on Asset Disposals					(881,489)	(1,138,816)



SHIRE OF NORTHAM

NOTES TO AND FORMING PART OF THE STATEMENT OF FINANCIAL ACTIVITY

FOR THE PERIOD ENDING 31 DECEMBER 2019

5 INFORMATION ON BORROWINGS

(a) Debenture Repayments

Particulars	Principal 1-Jul-19	New Loans		Principal Repayments		Principal Outstanding		Interest Repayments	
		19/20 Budget \$	19/20 Ytd Actual \$	19/20 Budget \$	19/20 Ytd Actual \$	19/20 Budget \$	19/20 Ytd Actual \$	19/20 Budget \$	19/20 Ytd Actual \$
Recreation & Culture									
Loan 208 - Northam Country Club **	7.36%	3,235	0	3,238	3,236	(3)	(3)	153	(4)
Loan 219A - Northam Bowling Club **	3.18%	163,041	0	19,575	9,710	143,466	153,331	8,854	1,998
Loan 223 - Recreation Facilities	6.06%	130,050	0	130,049	64,053	1	65,997	10,136	3,229
Loan 224 - Recreation Facilities	6.48%	816,395	0	46,765	23,010	769,630	793,385	57,285	14,681
Loan 227 - Youth Space	2.26%	500,000	0	45,097	0	454,903	500,000	12,110	0
Loan 228 - Swimming Pool	1.88%	0	4,500,000	€2,868	0	4,437,132	4,500,000	58,868	0
Economic Services									
Loan 225 - Victoria Oval Purchase	6.48%	667,960	0	38,262	18,826	629,698	649,134	51,781	12,012
		2,280,681	4,500,000	345,854	118,835	6,434,827	6,661,844	199,187	31,916

Note: ** indicates self - supporting loans

All other debenture repayments are to be financed by general purpose revenue.



SHIRE OF NORTHAM
NOTES TO AND FORMING PART OF THE STATEMENT OF FINANCIAL ACTIVITY
FOR THE PERIOD ENDING 31 DECEMBER 2019

	19/20 Budget				19/20 Ytd Actual					
	Opening Bal	Interest	Tfr To Reserve	Tfr From Reserve	Total	Opening Bal	Interest	Tfr To Reserve	Tfr From Reserve	Total
6. RESERVES - CASH BACKED										
Employee Liability Reserve	427,796	10,234		(32,574)	405,456	427,796	2,299		(32,574)	397,521
Aged Accomodation Reserve	227,404	5,440	5,000	-	237,844	227,404	1,287			228,691
Housing Reserve	265,507	6,352		-	271,859	265,508	1,503			267,011
Office Equipment Reserve	74,735	1788		(42,276)	34,247	74,735	769			75,504
Plant & Equipment Reserve	126,838	3,034	230,000	(240,000)	119,872	126,838	680	220,000	(230,000)	117,518
Road & Bridgeworks Reserve	89,498	2,141	200,000	-	291,639	89,498	507			90,005
Refuse Site Reserve	627,552	15,014	120,000	(266,850)	495,716	627,553	3,553			631,106
Regional Development Reserve	73,599	1,761		(50,000)	25,360	73,600	417			74,017
Speedway Reserve	147,600	3,531		-	151,131	147,601	836			148,437
Community Bus Replacement Reserve	2,414	58	15,000	-	17,472	2,414	14			2,428
Septage Pond Reserve	267,085	6,390		(58,643)	214,832	267,085	1,512			268,597
Killara Reserve	276,579	6,617	4,000	(59,643)	227,553	276,579	1,566			278,145
Stormwater Drainage Projects Reserve	33,593	804		-	34,397	33,593	190			33,783
Recreation and Community Facilities Reserve	584,376	13,981	1,193,500	(1,209,953)	581,904	584,377	1,934		(364,453)	221,858
Administration Office Reserve	685,801	16,407	300,000	(697,500)	304,708	685,802	3,538			689,340
Council Buildings & Amenities Reserve	348,744	8,343	290,436	(211,850)	435,673	348,744	1,384		(156,500)	193,628
River Management Reserve	360,240	8,618		(20,000)	348,858	360,240	2,039			362,279
Parking Facilities Construction Reserve	216,138	5,171		(65,000)	156,309	216,138	1,224			217,362
Art Collection Reserve	23,205	555		-	23,760	23,205	131			23,336
Reticulation Scheme Reserve	80,662	1,930	10,000	(8,950)	83,642	80,662	457			81,119
Election Reserve	15,165	363		(15,000)	528	15,165	29		(15,000)	194
Revaluation Reserve	61,351	1,468	10,000	-	72,819	61,351	347			61,698
Total Cash Backed Reserves	5,015,882	120,000	2,377,936	(2,978,239)	4,535,579	5,015,888	26,216	220,000	(798,527)	4,463,577

Total Interest & Transfers 2,497,936

All of the above reserve accounts are to be supported by money held in financial institutions.



SHIRE OF NORTHAM

NOTES TO AND FORMING PART OF THE STATEMENT OF FINANCIAL ACTIVITY

FOR THE PERIOD ENDING 31 DECEMBER 2019

	19/20 Budget	19/20 Ytd Actual	18/19 Financial Report
	\$	\$	\$
7. NET CURRENT ASSETS			
Composition of Estimated Net Current Asset Position			
CURRENT ASSETS			
Cash - Unrestricted	842,676	5,026,160	1,983,523
Cash - Restricted Unspent Grants	0	0	1,124,363
Cash - Restricted Reserves	4,535,579	4,463,576	5,015,888
Self Supporting Loan	25,095	11,910	15,758
Receivables	2,915,065	220,065	3,308,497
Rates - Current	0	5,353,406	0
Pensioners Rates Rebate	0	27,450	0
Provision for Doubtful Debts	0	(131,842)	0
GST Receivable	0	(48,477)	0
Accrued Income/Prepayments	0	1,654,848	1,933,962
Inventories	1,000	0	0
	<u>8,319,415</u>	<u>16,577,096</u>	<u>13,381,990</u>
LESS: CURRENT LIABILITIES			
	<u>(4,825,204)</u>	<u>(1,213,564)</u>	<u>(5,145,568)</u>
NET CURRENT ASSET POSITION	<u>3,494,211</u>	<u>15,363,532</u>	<u>8,236,422</u>
Less: Cash - Reserves - Restricted	(4,535,579)	(4,463,576)	(5,015,888)
Add: Current Loan Liability	385,911	138,726	279,985
Add: Leave Liability Reserve	405,457	228,691	427,796
Add: Budgeted Leave	250,000	250,000	250,000
ESTIMATED SURPLUS/(DEFICIENCY) C/FWD	<u>0</u>	<u>11,517,374</u>	<u>4,178,315</u>

SHIRE OF NORTHAM
RATING REPORT
FOR THE PERIOD ENDED 31 DECEMBER 2019

	2011/12	2012/13	2013/14	2014/15	2015/16	2016/17	2017/18	2018/19	2019/20
Key Rating Dates									
RATES ISSUED	08/08/2011	5/08/2012	4/09/2013	14/08/14	14/08/15	19/08/2016	1/08/2017	15/08/2018	4/09/2019
RATES DUE	22/09/2011	24/09/2012	23/10/2013	8/10/2014	25/09/2015	30/09/2016	14/09/2017	19/09/2018	9/10/2019
2nd INSTALMENT DUE	22/11/2011	16/11/2012	23/12/2013	8/12/2014	25/11/2015	30/11/2016	14/11/2017	19/11/2018	9/12/2019
3rd INSTALMENT DUE	23/01/2012	29/01/2013	24/02/2014	9/02/2015	25/01/2016	30/01/2017	15/01/2018	21/01/2018	10/02/2020
4th INSTALMENT DUE	22/03/2012	29/03/2013	24/04/2014	9/04/2015	28/03/2016	30/03/2017	15/03/2018	21/03/2018	14/04/2020
Outstanding 1st July	\$521,194	\$562,531	\$568,647	\$716,120	\$873,688	\$1,116,220	\$1,483,688	\$1,535,793	\$1,737,187
Rates Levied	\$6,851,708	\$7,312,029	\$7,758,147	\$8,222,616	\$8,552,189	\$8,931,257	\$9,564,551	\$9,925,046	\$10,342,585
Interest, Ex gratia, interim and back rates less writeoffs	\$63,079	\$68,857	\$73,630	\$80,154	\$83,173	\$208,077	\$205,216	\$474,784	\$106,400
Rates paid by month									
1 July	51,948	38,805	47,443	62,554	29,105	43,333	60,002	94,638	87,543
2 August	1,120,912	1,043,183	23,981	119,840	700,198	387,776	2,054,983	1,856,889	213,195
3 September	3,251,815	3,604,324	1,152,416	2,650,420	4,519,842	4,243,288	3,764,731	4,014,835	2,829,221
4 October	318,701	443,703	3,790,646	2,550,091	630,888	1,166,136	484,607	590,724	3,255,037
5 November	689,461	680,522	444,497	508,022	842,856	908,844	1,036,340	952,902	574,138
6 December	172,178	160,665	685,338	654,900	214,507	336,154	189,794	239,893	724,440
7 January									
8 February									
9 March									
10 April									
11 May									
12 June									
Total YTD	5,605,015	5,971,182	6,144,300	6,543,827	6,937,395	7,065,530	7,590,457	7,749,861	7,683,575
% Ytd Rates Outstanding	24.6%	24.8%	26.9%	27.4%	27.0%	31.1%	32.5%	35.1%	36.9%

Ytd Outstanding 1,830,964 1,972,236 2,256,123 2,475,062 2,571,652 3,190,025 3,662,998 4,185,763 4,502,597

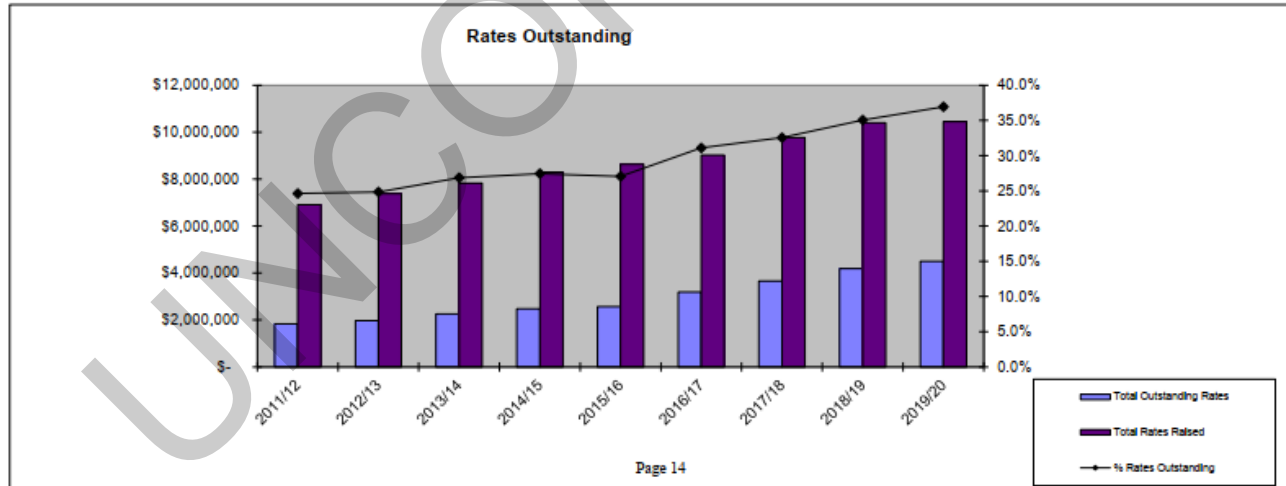

12.5 COMMUNITY SERVICES

12.5.1 Donation of Dulcie Armstrong Paintings to the Shire of Northam Art Collection

Address:	N/A
Owner:	N/A
Applicant:	N/A
File Reference:	8.1.2.6
Reporting Officer:	Jaime Hawkins, Community Development Officer
Responsible Officer:	Ross Rayson, Executive Manager Community Services
Officer Declaration of Interest:	Nil
Voting Requirement:	Simple Majority
Press release to be issued:	No

BRIEF

A member of the public has contacted the Shire of Northam with an offer to donate two original oil paintings from artist Dulcie Armstrong (dec) to the Shire of Northam Art Collection. The artworks are titled "Between Showers" (1977) and "White Gums at Warranine" (1977). The subject of these artworks are believed to be landscapes of the Clackline area.

ATTACHMENTS

- Attachment 1: Photograph of artwork "Between Showers"
- Attachment 2: Identifying details of artwork "Between Showers"
- Attachment 3: Photograph of artwork "White Gums at Warranine"
- Attachment 4: Identifying details of artwork "White Gums at Warranine"

A. BACKGROUND / DETAILS

It is believed that the artist was based in Clackline and that the subject of these oil paintings are of local landscapes.

There are two other Dulcie Armstrong paintings in the Shire of Northam Art Collection. "Avon Valley Country" (1979) was valued at \$880 in 2010, and "Countryside at Northam" (1979) was last valued in 2013 at \$550. The value of the artworks being offered are unknown. They are said to be in good condition, but have not been physically sighted by Shire Officers.

B. CONSIDERATIONS

B.1 Strategic Community / Corporate Business Plan

Theme Area 2: Community Wellbeing.

Outcome 2.2: There are a variety of recreation and leisure activities available for all ages, across the Shire of Northam.

Objective: Facilitate the provision of varied cultural and artistic activities.

B.2 Financial / Resource Implications

Council has an annual budget allocation for the ongoing management and maintenance of the art collection.

B.3 Legislative Compliance

N/A

B.4 Policy Implications

The Shire of Northam Art Collection Policy provides direction for Acquisition and Development of the collection, as such:

- *Acquisition and Development*
 - *New acquisitions will consolidate the existing selection.*
 - *The Shire of Northam will not be bound to acquire any artwork or accept any donations.*
 - *All acquisitions will be made on the advice and recommendation of the Shire of Northam Art Collection Committee.*
 - *New acquisitions will primarily be from emerging and established artists living and working in the Shire of Northam and surrounding districts.*
 - *Consideration will be given to public safety, display, storage, conservation and transport issues of a potential acquisition.*
 - *Artwork acquisition and donation, including public art will be considered based on the following criteria:*
 - *Excellence – quality of design and execution based on conceptual rationale and innovation;*
 - *Diversity – range of media catering to a diverse audience;*
 - *Originality – essence of artwork not copying an existing one;*
 - *Feasibility – affordability and long-term cultural value or investment potential;*
 - *Location – appropriateness of the work to the chosen site including integration with landscaping and architecture;*
 - *Conservation – durability, robustness and ongoing maintenance requirements;*

- *Interpretation – works that reflect the Shire's history, culture or sense of place;*
- *Public safety – ensuring there is no unacceptable level of risk associated with any public art proposal;*
- *Useful life – ephemeral or permanent;*
- *Interaction – encourages audience participation.*

As the Art Advisory Committee has been disbanded, this item has been submitted to council for resolution, and Policy 3.3, Art Collection Policy, will be amended to reflect the change.

B.5 Stakeholder Engagement / Consultation

There has been no stakeholder engagement or consultation relating to this item.

B.6 Risk Implications

Risk Category	Description	Rating (consequence x likelihood)	Mitigation Action
Financial	There is a significant cost to Council by acquiring this artwork.	Low	There is no significant additional cost to Council from these acquisitions.
Health & Safety	Nil		
Reputation	Council art collection diminishes in significance and value.	Low	Ensure proposed acquisitions occur by following art collection policy.
Service Interruption	Nil		
Compliance	Artwork acquired without following proper process.	Low	As the Art Management Committee has been disbanded, item submitted direct to Council for approval.
Property	Nil		
Environment	Nil		

C. OFFICER'S COMMENT

The artworks being offered by way of donation to the Shire of Northam Art Collection meet the criteria for new acquisitions to the Shire of Northam Art Collection as specified in the Art Collection Policy.

RECOMMENDATION / COUNCIL DECISION

Minute No: C.3865

Moved: Cr Little

Seconded: Cr Williams

That Council accept the following donation of artworks to the Shire of Northam Art Collection:

- **'Between Showers' by Dulcie Armstrong; and**
- **'White Gums at Warranine' by Dulcie Armstrong.**

CARRIED 10/0

Clarification was sought in relation to the value of the Dulcie Armstrong artwork in Council's collection. The Executive Manager Community Services confirmed that these were valued at approximately \$500 and \$700 at the most recent valuation.

Attachment 1: Photograph of artwork "Between Showers"



Attachment 2: Identifying details of artwork "Between Showers"

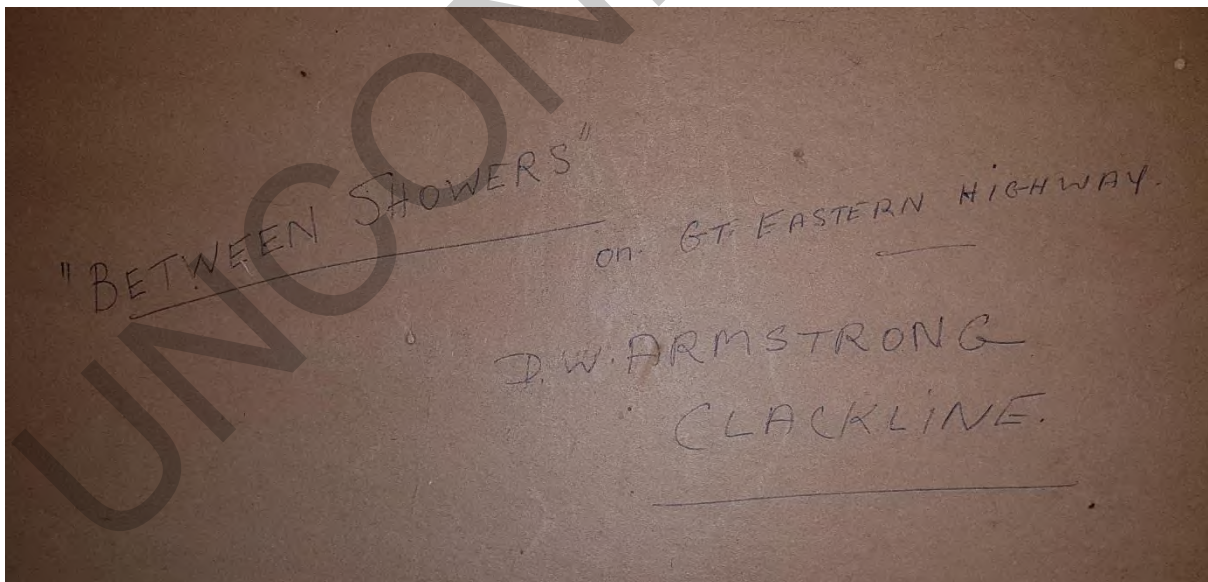

Attachment 3: Photograph of artwork "White Gums at Warranine"



Attachment 4: Identifying details of artwork "White Gums at Warranine"

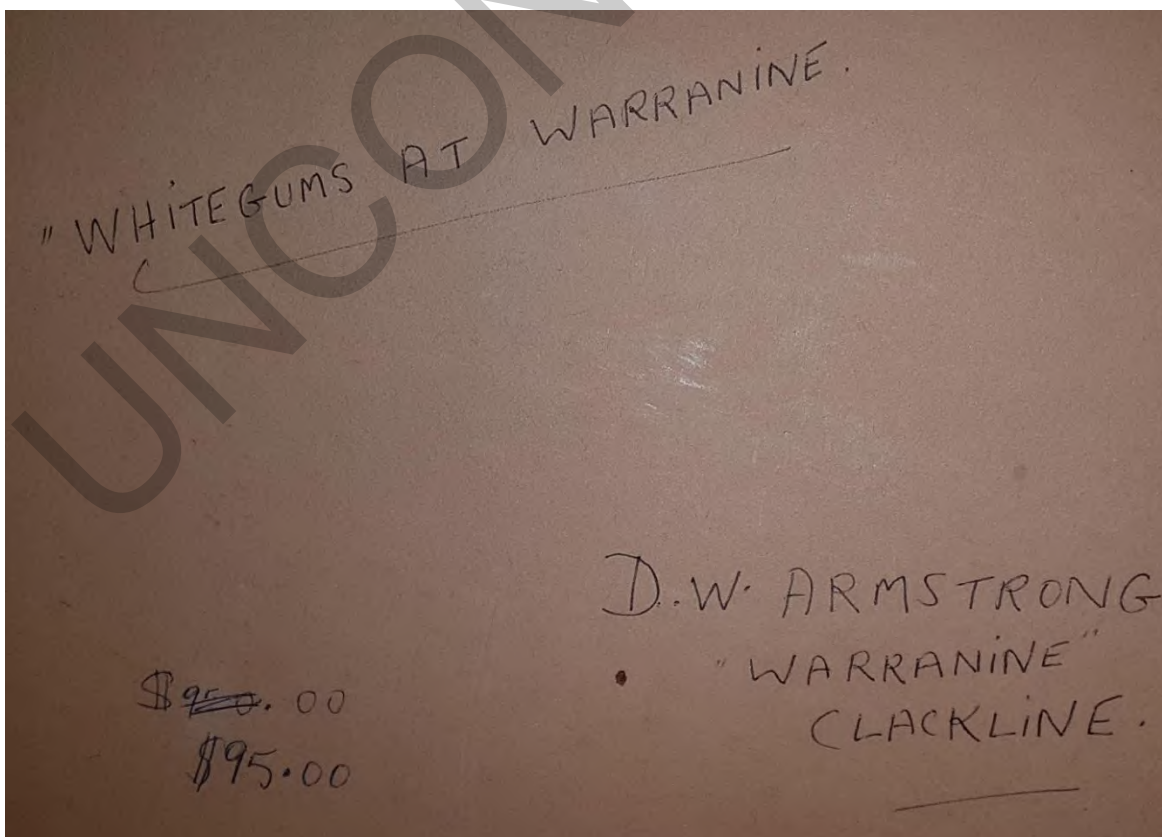

Cr R W Tinetti declared a "Proximity" interest in item 12.5.2 - Gordon Place Art – Mural as the wall on his place of business has been included as a possible location for an art mural.

Cr M I Girak declared an "Impartiality" interest in item 12.5.2 - Gordon Place Art – Mural as she knows the owners of the building on Gordon Place. The extent of her interest is minor and it will not affect her decision.

Cr Tinetti left the meeting at 6:07pm.

12.5.2 Gordon Place Art - Mural

Address:	232 Fitzgerald Street (Gordon Place wall)
Owner:	CD Smith
Applicant:	Shire of Northam
File Reference:	A11122
Reporting Officer:	Jason Whiteaker, Chief Executive Officer
Responsible Officer:	Ross Rayson, Executive Manager Community Services
Officer Declaration of Interest:	Nil
Voting Requirement:	Simple Majority
Press release to be issued:	Yes, Once approved by Council

BRIEF

At the Art Advisory Committee Meeting of April 2019, a proposal was presented by a local artist to develop a mural in Gordon Place. The development of a mural in this space was identified as a priority in the Northam CBD Connectivity Strategy, along with the range of other enhancements to this area (which has now all been completed). At the time the local artist proposal was rejected, with the Committee requesting staff to do more research into a potential process for a wider laneway strategy to achieve art (cultural), tourism and economic outcomes.

ATTACHMENTS

Attachment 1: FORM Proposal.

A. BACKGROUND / DETAILS

The Northam CBD Connectivity Strategy identified public art and murals as an important addition to the Northam CBD, to not only add colour to the area, but to also promote tourism and economic / activation outcomes.

Specifically, the CBD Activation Strategy identifies the following when it comes to murals;

- Strategy Three – Streets as places (page 14)
 - Sub-strategy 1- Establish a street hierarchy and upgrade to support economic performance
 - 1.2.1 – Introducing public art/activation on blank facades
 - 1.2.2 Include wayfinding, interpretation, murals and public art
- Strategy Five – Brightscaping (page 22);
 - Sub –Strategy 3. Develop Gordon Place as a focal point, and a pilot project of the “Better Block” concept
 - 3.3 – Painting of the blank walls with edgy urban art/murals

Building on this opportunity Northam was fortunate enough to have the first Silo painted with a mural artwork in Australia. This work was facilitated by FORM and has generated tourism interest in what is now a public art silo trail. FORM are currently in the process of increasing marketing of this trail which has the potential to bring significant numbers of people into the area. As a consequence the development of further art works in Northam provides an opportunity to leverage the FORM silo work and bring people into Northam.

In order to do this the artwork, it is considered, needs to be a sufficiently high quality and be undertaken in some form by artists with a profile.

To achieve this, FORM have submitted a Mural Project proposal which provides an indicative budget for this size of mural. This provides Council with some information on the average cost going forward for each proposed location.

B. CONSIDERATIONS

B.1 Strategic Community / Corporate Business Plan

Theme Area 1: Economic Growth.

Outcome: Northam central business area is a strong and vibrant centre with a variety of cultural/art, retail and hospitality choices on offer every day of the week.

Objective: An activated and attractive town centre with lower retail vacancy rates.

B.2 Financial / Resource Implications

A budget to deliver a mural at one location (Gordon Place) has been developed for the consideration of Council. The indicative budget is approximately \$34,000.

Council has allocated \$165,000 to Street scaping works (103173540). Approximately \$100,000 has been allocated to the streetscape works at the rear of the DOME Café.

B.3 Legislative Compliance

Nil.

B.4 Policy Implications

Councils Art Collection Policy provides the mechanism for recommendations to Council on Art Acquisition and Development, particularly that all acquisitions will be made on recommendation of the Shire of Northam Art Advisory Committee. As this Committee has been disbanded, this item was brought directly to Council for resolution.

Council Policy F4.2 Purchasing & Tender Policy, provides the mechanism to ensure consistency and efficiency for purchasing and procurement across all the Shire of Northam's operational areas in order to maximise value for the Shire and the community by obtaining the best balance of conditions of supply, quality and price.

FORM are considered to be the pre-eminent consultants in Public Art projects, particularly those that are creating tourism generation initiatives.

As FORM were the project managers for the Silo project, and the Mural art proposal for the CBD will be complimentary to this project, It is believed that FORM are the best suited to project manage this mural project, and as such no other quotes have been received for this proposal.

B.5 Stakeholder Engagement / Consultation

The CBD Connectivity Strategy was widely publicised and put out for community comment.

The owner of the building (subject of the proposed mural) has been consulted with and is supportive of the concept.

B.6 Risk Implications

Risk Category	Description	Rating (consequence x likelihood)	Mitigation Action
Financial	The financial cost to Council exceeds the proposed amount.	Low (4)	Ensure project agreement is strict on budget parameters
Health & Safety	Nil		
Reputation	Council does not deliver on its CBD Connectivity Strategy	Low (1x3) (4)	This report to Council recommending further action

Service Interruption	Access to Gordon Place restricted whilst project underway	Low (2)	Ensure works are carried out in a timely manner and all access restrictions are advertised appropriately to the community
Compliance	Nil		
Property	Property owner does not agree with proposal	Low (2)	Council officers liaise with owner to gain approval prior to project commencing Project progress communicated to owner on a regular basis
Environment	Nil		

C. OFFICER'S COMMENT

The concept being put forward by FORM is around leveraging opportunities to create areas of interest and draw people (locals and tourists) to spaces in the Northam CBD. The proposal aligns with the CBD Connectivity Strategy, although it does build on the recommendations in that it promotes the use of artists with profiles as a draw to the community.

In relation to an overall strategy for artworks, it is recommended that the CBD Connectivity Strategy be used as this basis. It is proposed that the strategy for laneway developments would look to leverage the hierarchy of access ways established in the strategy and align this to the laneway art strategy.

This notion would see priority laneways and access ways being reserved for public art by artists with a state, national or international profile, with the secondary laneways providing opportunity for local artists (from the Shire of Northam and other areas in regional WA) to develop their art work and profile (again leveraging the recognised artists). As such it is proposed that the following priority locations be reserved for profile artists:

- Gairdner Street (Flour Mill)
- Beavis Place (Funeral Directors Wall)
- Gordon Place

In addition to the above locations, officers believe that the laneway adjacent to Hit FM radio (near DOME) be included in this group as it is seen as a significant access way between Fitzgerald Street and the river, once DOME is open.



Whilst it is proposed that the proposed murals should be edgy urban art, themes for the proposed murals should reflect one of the following one or some of the following themes;

- The Avon River/water recreation/Avon Descent
- Local people's stories / profiles
- Hot air ballooning
- Northam as a social hub (historical social spots, sporting culture, or tap into local rituals)
- Aboriginal Culture

Other laneways would be promoted for use by local artists, with Council calling for expressions of interest (which would include design proposals). There would be guidelines placed around the expressions of interest which would reflect the CDB Connectivity strategy being;

- Themes for the proposed murals should reflect;
 - The Avon River/water recreation/Avon Descent
 - Local people's stories / profiles
 - Hot air ballooning
 - Northam as a social hub (historical social spots, sporting culture, or tap into local rituals)
 - The style must be edgy/urban art

RECOMMENDATION

That Council;

1. Engage FORM to project manage the delivery of a mural in Gordon Place Northam in accordance with their submitted proposal, acknowledging that final selection of the artwork is to be made by Council staff.
2. Advertise for local artists (preferably from the Shire of Northam or Wheatbelt Region) to submit design proposals and costing for the development of a mural in a priority 2 location, for approval by Council staff.

MOTION

Moved: Cr Girak

Seconded: Cr Ryan

That Council;

- 1. Engage FORM to project manage the delivery of a mural in Gordon Place Northam in accordance with their submitted proposal, acknowledging that final selection of the artwork is to be made by a transparent selection process by residents voting for the artwork on the Shire of Northam website.**
- 2. Advertise for local artists (preferably from the Shire of Northam or Wheatbelt Region) to submit design proposals and costing for the development of a mural in a priority 2 location, for approval by Council staff.**

LOST 4/5

Clarification was sought in relation to whether it is possible to eliminate non-residents from the voting process? The Acting CEO advised that it would be difficult to filter these out through an online voting platform.

Debate was held around the motion. Cr Girak, Cr Ryan and Cr Mencshelyi spoke for the motion. Cr Pollard, Cr Della and Cr Little spoke against the motion. Cr Girak used her right of reply to close the debate.

MOTION / COUNCIL DECISION

Minute No: C.3866

Moved: Cr Girak

Seconded: Cr Ryan

That Council;

- 1. Engage FORM to project manage the delivery of a mural in Gordon Place Northam in accordance with their submitted proposal, acknowledging that final selection of the artwork is to be made by a panel from each of the following groups;**
 - **2x Shire of Northam staff members;**
 - **2x Shire of Northam Elected Members;**
 - **1x Representative from the Avon Valley Arts Society;**
 - **1x Community representative;**
 - **1x Business owner along Gordon Place; and**
 - **1x Representative from the Northam Chamber of Commerce.**
- 2. Authorise the CEO to advertise for a community representative to be included on the panel with the final selection of panel members being determined by the Council.**
- 3. Advertise for local artists (preferably from the Shire of Northam or Wheatbelt Region) to submit design proposals and costing for the development of a mural in a priority 2 location, for approval by Council staff.**

CARRIED 5/4

Debate was held around the motion. Cr Girak and Cr Ryan spoke for the motion. Cr Pollard spoke against the motion. Cr Girak used her right of reply to close the debate.

Cr Little proposed an amendment to the motion to limit the panel to two staff members, two Elected Members, one representative from the Avon Valley Art Society, one community representative, one business owner along Gordon Place and one representative from the Northam Chamber of Commerce. The mover and seconder supported the proposed amendment which was included into the motion.

Cr Tinetti returned to the meeting at 6:47pm.

Attachment 1

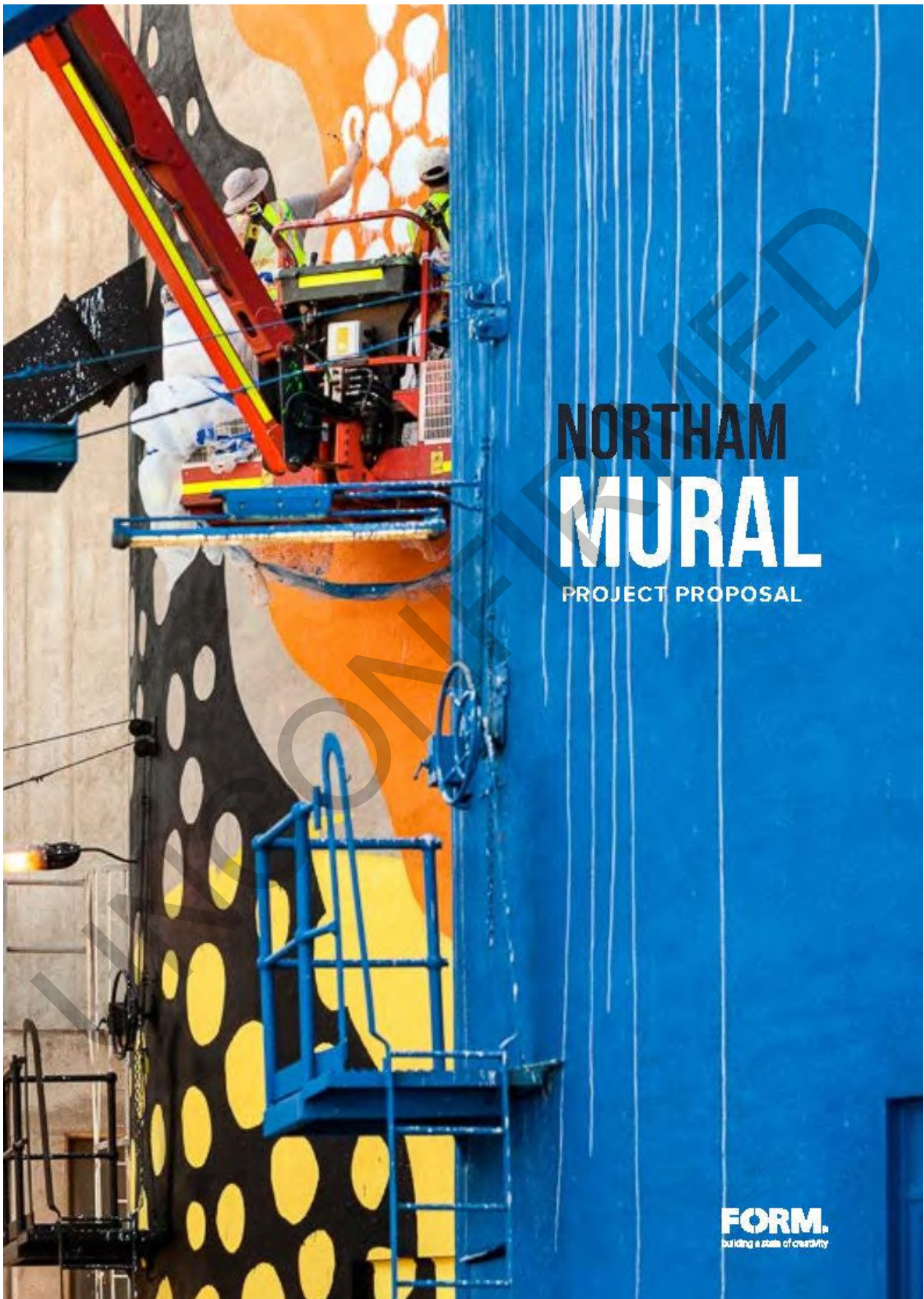



PROPOSAL

The Shire of Katanning has requested that FORM provide further information on the procurement process for a series of large-scale murals to be installed on walls in the Northam CBD.

Specific wall locations are yet to be determined, but featured in this proposal is the Gordon Place laneway and the facade of one of the Flour Mill buildings, facing out onto the Avon Bridge as you enter town.

This proposal outlines the budget, materials and project phasing, as well as examples of similar projects managed by FORM.

CONTEXT

Located in the heart of the picturesque Avon Valley, the Shire of Northam is a Wheatbelt town located approximately 96km east of Perth.

Well known for its diverse architecture and restored heritage buildings, the Avon River, world-class events such as the National Championships for hot air ballooning, the Avon Decent and more recently the Bilya Koort Boodja (BKB) Centre for Nyoongar Culture and Environmental Knowledge, Northam provides visitors and residents alike with many opportunities for event-based recreation and cultural engagement, but could benefit from more permanent interventions in strategic locations, that encourage visitors to spend more time exploring the town.

With the development along Wellington Street drawing foot traffic away from the main high street (Fitzgerald Street), there is an opportunity for mural interventions in strategic locations that will help to create a point of interest and ultimately draw people into the main street and through the laneway into Minson Avenue where the BKB Centre is located on the river front.

Cover page: Heron, PUBLIC Site Visit, Northam (2015) Photograph by Beverly Shepler. Above: Chris Noon, Northam (2015) Photograph by Beverly Shepler.

INDICATIVE SITES

The following two walls are examples of potential opportunities that have been raised by the Shire of Northam.



 Gordon Place, looking north-west towards the Avon River.



 Northam Flour Mill on the Avon Bridge



FORM'S EXPERIENCE

FORM has extensive experience in working in regional communities delivering creative, cultural tourism based initiatives.

The PUBLIC Silo Trail, which is perhaps FORM's most recognised example of such projects, evolved from the award-winning PUBLIC festival of art and ideas (2014-2016) which created more than 170 artworks in public spaces across metropolitan and regional Western Australia. The aim of PUBLIC was to enhance public space, facilitate broad access to art for non-traditional arts audiences, and further the reputation of Western Australia as a vibrant, evocative and unique place to live and visit.

Through a partnership with CBH, the States primary grain handler, PUBLIC expanded beyond Perth's city limits in 2015, focusing on larger regional infrastructure as the canvas for artwork. In its pilot phase the partnership commissioned two major artworks on the grain silos in Northam by international artists Phlegm (UK) and Hense (USA). Based on the positive response to this pilot project, FORM and CBH Group extended their partnership to deliver a further five silo artwork installations to create a drivable tourism trail. These artworks can be seen in Merredin, Newdegate, Pingrup, Ravensthorpe and Albany.

Emerging from the PUBLIC and PUBLIC Silo Trail programs, FORM has delivered smaller mural projects in regional towns such as Port Hedland, Albany and Katanning, in addition to a multitude of singular, one off site specific artworks.

Through the work that we do and the communities that we communicate and collaborate with, it is evident that regional Western Australia faces multiple challenges. FORM is driven by these and the immense need to develop diverse opportunities for growth industries, economic activity as well as the need for improved social wellbeing through perceptions, pride and points of attraction to draw and retain talent for these towns and regions.

Top, Annet Island, PUBLIC CAMPUS, Coon Berrin, 2016. Photograph by Beverly Shepton.

Top right, Koolmambie, PUBLIC Silo Trail, Katanning, 2017. Photograph by Beverly Shepton. Mid, McVie and a view of a grain silo at St. Paul's Primary School, Katanning, 2017. Photograph by Beverly Shepton. Right, Silo Office, Katanning, 2019. Photograph by Mark Madson. Bottom left, Silo, PUBLIC Silo Trail, Katanning, 2017. Photograph by Beverly Shepton.

A CASE STUDY: KATANNING

In November 2017, FORM and Western Power, together with the Shire of Katanning, delivered the first of two projects aimed at creating a series of artworks and cultural opportunities for key regional Western Australian communities.

The Wheatbelt town of Katanning, located 277 km southeast of Perth, hosted the first iteration of the project, which consisted of a series of artworks on Western Power electrical transformer boxes at the four Katanning schools, and a large scale murals on prominent walls throughout town.

The artists involved were Western Australian's Mel McVee, Brenton See, Chris Nixon and Darren Hutchens and Karim Jabbari, a visiting artist from Tunisia.

A total of seven transformer boxes and five larger wall murals were created by these artists over a seven day period, with one further mural completed with the Shire at Perth based artist Peche, in early 2019.

Complimenting the artwork program was a series of youth workshops with Katanning students, and *The Core*, an exhibition of Karim Jabbari's light painting artworks inspired by the Great Southern and showcased at the Katanning Public Art Gallery.

An additional element of this project was the story gathering and social documentary project *Stories From the Six Towns* which catalogues and celebrates the stories of the people behind the State's agriculture and electrical networks, many of whom were also volunteers in the project.



INDICATIVE BUDGET*

	EXPENSE	NOTES
Concept Design Proposal Fees	\$1,500.00	For 4 artists to develop CDP's
Artist Fee	\$8,000.00	Depending on who the artist is, the wall etc.
Artist Travel	\$1,800.00	Including accommodation and assuming they are from WA
Production Manager Travel	\$2,000.00	Including car hire and accommodation for 1 staff member
Equipment	\$5,000.00	EWP plus delivery fees (dependent on what size EWP required)
Materials	\$2,500.00	Paints and painting materials
Marketing and Design	\$1,000.00	For the design and printing of any marketing collateral
Documentation	\$8,000.00	For filming or photography
Project Management	\$4,500.00	For management of project

TOTAL **\$34,100**
(Not incl. GST)

* This budget is indicative only and not for any one specific wall opportunity, rather an estimation based on a medium sized wall. Size, surface and accessibility all impact the cost of a mural, in addition to the type of artist or artwork. It makes the assumption that the artist is Western Australian, requiring less travel, it also includes a project management fee for FORM, however this could also be managed by the selected artist, depending on who is selected and what procurement method the Shire of Northam wishes to use. This does not include community consultation or engagement or public programming.

PROJECT PHASING

1 ENGAGE ARTIST

Upon recommendations FORM will present a list of suitable artists to work on the project, from which the client will appoint the selected artist to be commissioned, via one of the procurement options on the following page.

2 CONCEPT DEVELOPMENT

The commissioned artist will be thoroughly briefed on the artwork opportunity and will produce a concept for review.

3 CONCEPT REFINEMENT

Feedback will be issued to the artist and concept refined to the satisfaction of all parties. At this stage artist will be contracted and planning and logistics underway.

4 DELIVERY

Based on the refined design FORM and the selected artist will begin installation on site.



PROCUREMENT METHODOLOGY

OPTION 1

FORM will submit a shortlist of suggested artists based on preliminary discussions with the Shire of Northam. Selected artists will be provided a comprehensive brief that defines the vision, guiding principles and curatorial framework for the artwork in addition to socio-cultural, environmental, and historic contexts of the site.

Selected artists will then respond to the brief and submit Concept Design Proposals (CDPs) for a fee of \$375 each (exl. GST). From there the final artist selection will occur by the Shire of Northam, with FORM's support and will be directly commissioned and contracted.

The budget breakdown accounts for four CDPs to be requested, however this number is flexible if further budget is allocated.

OPTION 2

Alternatively, if required, FORM can develop a tender for an Expression of Interest (EOI) and implement an "open call" process by sending it out to our full artist database requesting written responses to the EOI in addition to examples of previous work and demonstrated capability.

From here FORM will present EOI's to the Shire of Northam to select a shortlist of artists to take through to a CDP round. On receipt of the artist brief, the selected artists will then develop their concept designs for a fee. From this step, the Shire of Northam will select the artist, with FORM's support.

If the second procurement option is preferred, this would likely extend the project timeline and increase the project management fee.

The level of community and stakeholder engagement is up to the discretion of the Shire, and is not included in this proposal.

Photography: © BUC Studio, Northam, 2015. Photographed by: Beverly Shaylor.

MORE INFORMATION

form.net.au
publicsilotrail.com

CONNECT WITH US

@formwa #publicsilotrail
@formwa (twitter)

pH 08 9385 2200

39 Guger Street,
Claremont, 6010 WA

CONTACT

Project Manager
Rhianna Pezzaniti

rhianna@form.net.au

FORM.
building a state of creativity

12.5.3 Short Stay Caravan Facilities Feasibility

Address:	N/A
Owner:	Shire of Northam
Applicant:	N/A
File Reference:	4.1.3.5
Reporting Officer:	Ross Rayson, Executive Manager Community Services
Responsible Officer:	Ross Rayson, Executive Manager Community Services
Officer Declaration of Interest:	Nil
Voting Requirement:	Simple Majority
Press release to be issued:	No

BRIEF

For Council to consider the report on the Feasibility of provision of short stay and day site facilities for caravans/RV's within the Shire of Northam. For the purpose of this report, Short Stay is defined as "a self contained 24 Hour RV/caravan site"

ATTACHMENTS

- Attachment 1: Feasibility Study Report.
- Attachment 2: Concept designs.
- Attachment 3: Indicative costings based on concept designs.

A. BACKGROUND / DETAILS

Since the construction of the Bilya Koort Boodja Centre, the Shire of Northam has been without an RV/caravan day site, and has not previously had a designated short stay site. There are a number of unauthorised locations within the Shire which are frequented by overnight campers.

Since the closure of the day site in Northam, there has been a number of enquiries from individuals and caravan and camping associations in respect to re-establishing a day site within the Northam town site.

In addition to this, recent Community planning exercises undertaken within both Wundowie and Bakers Hill identified the provision of formalised short stay caravan/camping as projects to be undertaken.

As campers and Recreation Vehicle (RV) users make up a large portion of Australia's tourist demographic. In an effort to attract more of this demographic to Northam, Council officers have explored the requirements for Northam to become registered as an "RV Friendly" town and whilst Northam meets most of the criteria, except:

- Provision of appropriate parking within the town centre, with access to a general shopping area for groceries and fresh produce
- Provision of short term, low cost overnight parking (24/48 hours) for self – contained recreational vehicles, as close as possible to the CBD.

In Wundowie and Bakers Hill, the communities saw the opportunity for short stay camping provision as a great opportunity for those communities to develop the tourism industry, and provide some support to the local businesses in those towns.

Additionally, feedback has been received from visitors regarding the lack of free overnight camping or day site facilities in the Shire of Northam, and it has become clear that many travellers are staying within the Shire of Northam at various sites free of charge anyway. The information on these "unauthorised" sites is often communicated between travellers.

As a result, Council has undertaken a feasibility study around the topic of free camping an RV day site within the Shire of Northam.

Given that the issue of short stay camping was identified in the community plans, this feasibility also investigated the options for establishing short stay site in Bakers Hill.

The consultants have provided a feasibility study report, concept plans and indicative costings for the preferred options identified.

B. CONSIDERATIONS

B.1 Strategic Community / Corporate Business Plan

Theme Area: Economic Growth

Outcome 1.4: A robust tourism industry which contributes to the economic development of the Shire of Northam and optimises Northam's role as a hub for tourists to the region.

Objective: Develop tourism opportunities based around the Shire's unique cultural, heritage and environmental assets.

B.2 Financial / Resource Implications

Currently there are no funds budgeted for this project development. Council would consider the project as part of the 20/21 annual budget. Indicative costings have been included in the attached report.

B.3 Legislative Compliance

Caravan Parks and Camping Grounds Act and Regulations.

B.4 Policy Implications

N/A.

B.5 Stakeholder Engagement / Consultation

No direct stakeholder engagement was undertaken as part of this feasibility. If Council chooses to progress further, stakeholder/community consultation will need to be undertaken prior to a final decision on the development of the short stay caravan site.

B.6 Risk Implications

Risk Category	Description	Rating (consequence x likelihood)	Mitigation Action
Financial	There are insufficient funds to undertake the projects	Low (3)	Council allocates funds in forthcoming budgets to undertake projects
Health & Safety	Illegal camping continues to increase within the Shire	Moderate (8)	Provision of properly planned It designated short stay sites within the Shire reduces risks from a health and safety point of view.
Reputation	Council undertakes development of short stay sites without consideration of any feedback received from public/stakeholder consultation	Low (2)	Consultation with any stakeholders/general community undertaken before any decision on development is made
Service Interruption	Nil		
Compliance	Illegal camping continues to increase within the Shire	Moderate	Provision of designated sites within the Shire, in accordance with relevant legislation

Property	Nil		
Environment	Illegal camping continues to increase within the Shire resulting in increased environmental issues (e.g. illegal dumping)	Low	Provision of designated sites within the Shire in accordance with relevant legislation

C. OFFICER'S COMMENT

The Feasibility study has identified preferred sites for a short stay in Northam, a day site in Northam and short stay in Bakers Hill. As stated in the report, it is recommended that the development of the different areas is staged, with the Day Site in Northam seen as the most cost effective and easiest to implement. The development of the Bakers Hill Site will require additional work in relation to planning issues, and therefore officers recommend that this project is undertaken as stage 2.

The final decision on the development of the RV Short Stay Area-Northam, will be subject to the outcomes of specific consultation being undertaken with Northam Caravan Park and Avon Valley Chalets owners, to determine any effects or benefits that will occur with the development of the short Stay area in Northam.

RECOMMENDATION / COUNCIL DECISION

Minute No: C.3867

Moved: Cr Della

Seconded: Cr Ryan

That Council:

- 1. Receives the Feasibility Study report on Short Stay Caravan Facilities Feasibility;**
- 2. Allocates funds in the 2020/21 draft budget to undertake development of the RV Day site in Northam;**
- 3. Allocates funds in the 2021/22 draft budget to undertake development of the RV Short Stay site in Bakers Hill; and**
- 4. Requests the Chief Executive Officer to report back to Council on the viability of the Short Stay site in Northam once a comprehensive stakeholder consultation has been undertaken.**

CARRIED 10/0

The Coordinator Governance / Administration left the meeting at 6:48pm and returned at 6:49pm.

Cr Pollard raised that the calculation of 'on costs' within Attachment 3 are not consistent/correct for the 10% and 5%.

Debate was held around the motion. Cr Della, Cr Ryan, Cr Tinetti and Cr Little spoke for the motion. Cr Pollard spoke against the motion. Cr Della used his right of reply to close the debate.

Attachment 1

Shire of Northam

Free Camping in Northam Feasibility Study

July 2019



ANNA DIXON CONSULTING

in collaboration with



architects www.stavinarch.com.au

Disclaimer

Anna Dixon Consulting has prepared this report exclusively for the use of the party or parties specified in the report (the client) for the purposes specified in the report (Purpose). The report must not be used by any person other than the client or a person authorised by the client or for any purpose other than the Purpose for which it was prepared.

The report is supplied in good faith and reflects the knowledge, expertise and experience of the consultants involved at the time of providing the report.

The matters dealt with in this report are limited to those requested by the client and those matters considered by Anna Dixon Consulting to be relevant for the Purpose.

The information, data, opinions, evaluations, assessments and analysis referred to in, or relied upon in the preparation of, this report have been obtained from and are based on sources believed by us to be reliable and up to date, but no responsibility will be accepted for any error of fact or opinion.

To the extent permitted by law, the opinions, recommendations, assessments and conclusions contained in this report are expressed without any warranties of any kind, express or implied.

Anna Dixon Consulting does not accept liability for any loss or damage including without limitation, compensatory, direct, indirect or consequential damages and claims of third parties, that may be caused directly or indirectly through the use of, reliance upon or interpretation of, the contents of the report.

Table of Contents

1	Background	2
2	Current Situation	3
3	Literature Review – Camping and RV Requirements	4
3.1	RV Friendly Town Status Requirements.....	4
4	Caravan & Camping Trends Analysis	5
5	Site Investigations	7
5.1	Northam CBD Day Area.....	7
5.2	Northam Short-Stay Area.....	8
5.3	Bakers Hill Short-Stay Area.....	9
6	Overview of Concept Designs	9
6.1	Northam Day Use Area.....	9
6.2	Northam Short-Stay Area.....	10
6.3	Bakers Hill Short-Stay Area.....	10
7	Case Studies	10
7.1	Case Study 1 – Bunbury Free Rest Areas.....	10
7.2	Case Study 2 – Shire of York RV Facilities.....	11
7.3	Case Study Three – ‘Experience’ Caravan Parks.....	14
8	Analysis of Potential Benefits	15
8.1	Economic Benefits.....	16
8.2	Environmental Benefits.....	19
8.3	Social Benefits.....	21
9	Recommendations on Site Development	22
Appendix – Excerpts from Wundowie Feasibility Study		25
Benchmarking – Similar Facilities.....		25
Overview of Requirements – Un-Manned Caravan Park.....		30
Overview of Concept Designs – Caravan Park.....		30
Management Models and Revenue Generation.....		30
Benefits – Short-Stay (Un-Manned) Caravan Park.....		31

1 Background

The Shire of Northam currently has no official free camping areas within the local government area, although there are known to be a number of locations where overnight stays do occur. The Shire of Northam notes the large proportion of the Australian tourist demographic which utilise caravanning and camping and is keen to see more of this segment of the market attracted to the region. The Shire has recently applied to be designated a 'Recreational Vehicle (RV) Friendly Town' and met all criteria other than the availability of a free, overnight camping facility near the town's CBD.

In addition to pursuing accreditation as an RV Friendly Town, the Shire of Northam is seeking to realise the ambitions of the communities of Bakers Hill and Wundowie to provide local caravanning options (as per their respective Community Plans) and explore the potential to develop camping locations in other areas. As such, the Shire of Northam commissioned this feasibility study and preparation of concept designs to provide an understanding of the potential benefits, issues and key considerations in furthering this project.

In our proposal, we did include the option of exploring locations outside of the key settlements of Northam, Bakers Hill and Wundowie (with the original scope including considering Clackline/Eadine Springs, Katrine Bridge and Grass Valley or equivalent locations). It was the preference of the Shire on acceptance of the proposal to focus on the key settlement locations featured in this study as they had the greatest likelihood of delivering economic benefit as they were in locations where there were businesses where visitors could engage in transactions with. In undertaking this study, irrespective of the economic benefits of the locations, further reinforcing the greater suitability of these locations are our findings around environmental impact of visitors along with visitor safety.

This report predominately explores the provision of amenities for RV users and marketing to this group. It does not focus on the camping segment of the market as it is deemed that provision of facilities required by this group (toilets, showers, water) would be unviable for the Shire to provided and that it would be preferable for non-self-contained visitors to utilise the services of Northam Caravan Park.

It should also be noted that Anna Dixon Consulting, in collaboration with Slavin Architects, recently completed a feasibility study and concept design which included exploring the development of a small, unstaffed caravan park in Wundowie. This piece of work, considered in conjunction with the further discussion of this study, is considered to cover the requirements of the project at this stage for this section of the Shire. For ease of the reader, the pertinent sections have been added to this study as an appendix.

2 Current Situation

As noted in the background, there are currently no formal free camping options within the Shire of Northam. Previously, there was day area for caravans within the CBD adjacent to the Visitor Centre on Minson Avenue, however this was decommissioned with the development of the Bilya Koort Boodja Centre on this site. This site had been popular with caravanners as it provide easy parking, power and water within easy walking distance of the CBD attractions. With the loss of this facility, many caravanners struggle to find parking within the townsite. There is currently a dump point in the carpark next to the train station.

Although there are no formal free camping locations within the Shire, there are a number of unofficial sites used by caravanners. The popular app, WikiCamps, is a user-generated repository of information about places to camp and visit across Australia. The app currently has listings for the following sites that are accessible for caravans:

- Clackline 31° 42' 36" S, 116° 33' 23" E - Basic pull-in off highway, not particularly flat, long drop toilet described as in poor state on WikiCamps.
- Eadine Springs 31° 42' 40" S, 116° 32' 38" E - Basic pull-in off highway, some picnic tables and bins. Road noise from highway noted on WikiCamps.
- 2 x pull-in off highway (one paid option at El Cabelo fuel station and another on side of highway near Wundowie - recorded on Wikicamps as very noisy and lots of rubbish)
- Wilkinson Park, Katrine, 31° 36' 56" S, 116° 33' 21" E - Picnic spot by river, short walk trail, near old church and historic homestead (not open to public), has toilets and some picnic seats and bins. Some flat ground.
- Grass Valley Tavern, 31° 38' 6" S, 116° 47' 45" E - Can free camp next to Tavern on private land. Tavern not currently open.
- Watson Road near Grass Valley 31° 38' 8" S, 116° 51' 50" E - Roadside stop, listed as quiet, not often used, only one comment from about 12 months ago.
- Meenaar Parking Area 31° 38' 29" S, 116° 55' 46" E - Parking area off highway, comments on WikiCamps about road noise from nearby highway.

There are two paid caravan parks within the Shire, one in the town site and one just on the outskirts of the townsite off Fox Road.

The Northam Caravan Park located on Yilgarn Avenue and approximately five kilometres from the CBD. The caravan park offers caravan sites along with cabins of a range of standards. The park is pet-friendly and has a camp kitchen, barbeque area, ablutions and laundry, along with a dump point. Visitors can book via their website or by calling the park direct. Comments on WikiCamp are generally very complimentary about the friendliness of the park, but a notable number of comments were about the park being difficult for large caravans/RVs and the need for improvements/better maintenance on facilities (camp kitchen and bathrooms).

Avon Valley Chalets offers eight basic chalets (two double and six single) along with nine powered caravan sites. There is an ablution block, laundry and barbeque area. Located in Burlong, just under eight kilometres from the CBD, the focus of marketing seems to be on people visiting for work purposes and seeking self-contained accommodation and people looking for a permanent site for a van (incentives offered to those building a permanent annex and staying over twelve months). The park does not appear to be listed on Wikicamps nor Tripadvisor and their online presence is limited to a Facebook page. The facility is managed by Avon Valley Professionals Real Estate.

3 Literature Review – Camping and RV Requirements

3.1 RV Friendly Town Status Requirements

The RV Friendly Town concept signals to RV tourists that they will be welcome there, that certain services will be provided for them, and that they have a safe place to stay for the night, or longer.

BENEFITS OF BEING PART OF THE RV FRIENDLY TOWN PROGRAM:

- Campervan and Motorhome Club of Australia (CMCA) will promote the town on GeoWiki, The Wanderer (CMCA's digital magazine), their website and their social media platforms.
- CMCA will publish a one-off article on the town in their monthly digital magazine, The Wanderer. The town will also be listed as an RV Friendly Town in each edition of the magazine.
- When RV travellers see the RV Friendly Town signage, they immediately know that an overnight parking/rest area will be available to them at a low cost, accompanied by certain services. If the town can also offer an incentive or reduced cost for CMCA members, patronage may be significantly increased.
- Visitors to the town will spread the word, via word of mouth, social media, and platforms such as WikiCamps or Trip Advisor, that the town is RV friendly.
- Increased RV travellers may contribute to a community environmentally, socially and economically. 97% of RV travellers make purchases when stopping in a town and spend an average of \$500 per week when on the road.¹
- Increased patronage of local tourist attractions and businesses, particularly in areas such as fuel and vehicle maintenance, living and medical expenses and accommodation costs.

¹CMCA Member Survey, 2009, Spend Profiles & Travel Habits, Whyalla Rally

CRITERIA TO QUALIFY AS AN RV FRIENDLY TOWN

Essential:

- Provide appropriate parking within the town centre, with access to a shopping area for groceries and fresh produce
- Short term, low cost overnight parking (24/48 hours) for self-contained RVs, as close as possible to the CBD.
- Access to potable water
- Access to a free dump point at an appropriate location

Desirable:

- Long term parking for self-contained RVs
- Access to medical facilities/services
- Access to a pharmacy or able to obtain pharmaceutical products
- Visitor Information Centre (VIC) with appropriate parking
- VIC to provide town map showing the above essential and desirable facilities
- RV Friendly Town signage to be erected within the town precinct

CMCA also considers the attitudes of the council and local business people when endorsing RV Friendly Town status.

4 Caravan & Camping Trends Analysis

Recent research based off caravanning and camping statistics^{2,3} collected from 2018 suggest an increase in the popularity of camping in Australia, despite industry challenges such as economic and political uncertainty, falling house prices, low household savings and a fall in new car sales. The market appears to be decreasing in age, despite the stereotype of grey nomad and empty nester caravanners, with a marked increase in both the 30-54 age bracket, and the under 30-category.

Australia's total recreational vehicle (RV) registrations increased by 5% to reach 679,393 from 2017 to 2018, and the numbers of RVs manufactured in 2018 represented a 38-year high. Australia has one of the highest rates of new RV registrations in the world, only just trailing the USA.

There has been a strong preference towards towables in the past 10 years, representing 93% of the RVs manufactured in Australia in 2018. There has also been a 9.1% increase in imports from 2017-2018, and 91% of the imports came from China.

² Caravan Industry Association of Australia, 2018, RV Consumer Report 2018

³ Caravan Industry Association of Australia, 2019, Caravan Stats Portal

In 2018, 1 in 13 Australian households had a registered RV, a year that also saw the largest number of domestic caravan or camping visitors in Australian history, with 53.5 million nights spent camping or caravanning around the country, representing a 7.1% increase from 2017. Of these nights spent camping or caravanning, 90% were spent in regional areas outside of capital cities. Total visitor expenditure for 2018 exceeded \$8 billion. These figures demonstrate the very important role that the caravan/camping industry plays in regional Australia's tourism industry. Furthermore, 80% of RV owners are willing to explore new destinations without planning in advance, resulting in a higher likelihood of visiting, and staying for longer periods, in regional areas.

Families are the largest market, with groups including children comprising 29% of all trips in 2018. Children are a significant factor, with 42% of current RV owners having children under 15 years living at home. Also, 67% of current RV owners camped when they were children, suggesting that family experiences are an important when purchasing an RV.

As previously mentioned, the market is gradually becoming younger, with the 30-54-year bracket making up 47% of all trips, followed by 55+ years at 29%, then 20-29-years at 18%. The increase in the younger market, particularly the under-30 age bracket, correlates with an increasing demand for experience and nature-based travel. 87% of current RV owners have said they enjoy outdoor activities such as hiking or fishing; with the average age of an RV owner sitting at 33 years, with an average income between \$48,000-\$72,000.

In addition to these domestic statistics, 370,000 international travellers incorporated caravanning or camping into their trip in 2018. The largest proportion of these was the 20-29-year bracket, making up 42% of trips. This correlates with the high number of backpackers who choose to go caravanning/camping.

However, backpacker numbers have plateaued in recent years, leading to an overall shorter average length of stay, as backpackers tend to stay for longer periods than other international travellers. A shorter trip means that visitors have a tendency to stay relatively close to their city of arrival, which means less time spent in regional areas.

Traditionally, RV owners frequented caravan parks, however in recent years free camping sites often with no or basic facilities have become increasingly popular. As the vast majority of RVs are fully self-contained now, access to facilities is becoming less important to travellers.

The free camps can be less desirable, from limited facilities, to the condition of the road in and out, to the proximity to local shops and attractions, along with a lack of allocated space and management of use meaning that regulation by the users is required. These potential detractors are also attractors to many free camp enthusiasts, with the appeal of remote and often scenic locations.

Like other industries experiencing disruption by emerging competitors (taxis and ride-sharing services, hotels and AirBnB, traditional retailers and online stores), the caravan park sector is faced with the challenge of adapting to changing market behaviour. Caravan park operators have a range of complex demand and supply issues⁴ to address to successfully navigate the evolution of the industry. Visitor expectations of the quality of facilities is increasing, with clean and modern ablutions being key along with growing demand for resort-style amenities and activities. Visitors increasingly seek an 'experience' at caravan parks, rather than simply a place to connect to services.

Caravan ownership models are also changing, with an emerging trend in camping and caravanning the concept nicknamed the 'Airbnb of camping'. It is a similar concept to Airbnb, as well as the more traditional idea of owning an investment property that you can use yourself whenever you like, but the other 48-odd weeks of the year, instead of having it sit empty, you lease it out to other holiday-makers who can't afford a holiday house of their own.

Transfer this concept across to caravans and campervans, and the result has been the growth of share community websites like Camplify and Share-A-Camper. Owners can set up a page listing their vehicle with details like nightly rates, availabilities and features (even options such as providing the vehicle set up at a destination). Camplify has 2800 owners registered with its site, and around 200,000 users, 75% of whom are families.

5 Site Investigations

5.1 Northam CBD Day Area

Three potential sites were considered, with the Minson Avenue option identified as the preferred solution:

- Broome Terrace – The possibility of reclaiming some parking and grassed area along the river was considered, however it was considered the area had inadequate space and would have a negative impact on residential properties. Work to develop clear wayfinding would be required to allow visitors to navigate to town via the shortest route and/or take into account mobility issues that the suspension bridge may impact on.
- Peel Terrace – The parking area adjacent to the current dump point was considered, however the distance from the CBD made this location less desirable. It could be used as 'overflow' for day use during busy periods.
- Minson Avenue – The existing carpark at Bernard Park is already being used unofficially by caravanners and some realignment and widening of the carpark could retain a similar number of car bays, while creating an additional one-way

⁴Tourism Western Australia, 2007, Understanding the Caravan Park Industry in Western Australia.

parking option for RVs to cater for around five vehicles. Alternatively, there is an option for retaining the existing carpark size and reducing the number of parking bays could allow for RV parking within the current surfaced area. This site offers the benefit of proximity to existing toilets, the Visitor Centre and the attractions of the CBD.

5.2 Northam Short-Stay Area

Three sites were considered for a short-stay area within Northam, with the Mitchell Avenue option being identified as the most appropriate.

- **Enright Park** – While relatively flat and open space, this site is of significance to Traditional Owners, the Noongar People on Balladong Country, as one of the last Kabori Grounds in the Avon region. The site is registered under the Aboriginal Heritage Act 1972. This park is also immediately adjacent to the East-West rail line which would have significant noise impact on visitors. The park is situated at the meeting point of the Avon and Mortlock Rivers and, while scenic when the rivers are flowing, the ephemeral nature of the rivers mean that for a large part of the year they are dry and can be very odorous.
- **Clarke Street** – The site of the old Northam Skate Park was considered however, like Enright Park, it is impacted on by both the rail line and river conditions. It was also considered to be undesirable to have itinerant visitors in close proximity to Northam Senior High School. This area is also marked as a potential location for an off-leash dog exercise area. It does offer the benefit to visitors of only being approximately one kilometre from the CBD but this was not considered sufficient benefit to outweigh the other issues.
- **Mitchell Avenue** – The site of an old caravan park behind the Northam Olympic Swimming Pool Complex was considered and identified as a flat, accessible space with the benefit of an existing leach drain. The size and layout of the site facilitates the development of drive-through bays which is preferable given the area will be unattended and limits issues with inexperienced caravaners needing to reverse, as well as improving safety by eliminating the risks associated with reversing vehicles particularly where children can be at play. The site offers shady, established trees and views of a section of the Avon River which does not tend to go dry, although the flow is seasonal with the water being still and brackish during dry months. The site serviced by a dual-purpose path into the CBD and is in close proximity to the start of the Kep Track. At approximately four kilometres from the CBD, it is at a walkable distance but does not create a strong competitive advantage over the existing caravan park which is five kilometres from the CBD.

5.3 Bakers Hill Short-Stay Area

Examining the Bakers Hill area only one possible site was determined as having potential. This area is the reserve along the disused railway line running parallel to Newman Street. The site is protected from highway noise and has sweeping views across a short valley and farm land. This location offers flat land nestled amongst established trees while in close proximity to, brewery/restaurant, tavern, bakery and other shops and amenities. It is also adjacent to the Bakers Hill siding which offers the potential to be restored as a tourist attraction.

6 Overview of Concept Designs

An overview of each of the Concept Designs developed as part of this study are provided below (and Wundowie's option outlined in the report Appendix) and the drawings have been delivered with this report. Additionally, a budget costing undertaken by Wilde and Woolward has estimated the costs at:

- Northam Day Use Area - \$83,000
- Northam Short Stay - \$115,000
- Bakers Hill Short Stay - \$95,000
- Wundowie Caravan Park - \$441,000

Costings have allowed for Claycrete treatment of the base for non-bitumen roads and tracks; however it is the view of Slavin Architects that the level of activity will be relatively light and not requiring any additional treatment to surfaces in the foreseeable future.

6.1 Northam Day Use Area

The development of a Day Use Area (see SK100) is recommended in the Bernard Park parking area on Minson Avenue. This could be achieved through the realignment of the parking bays and some minor landscaping to narrow the existing (over width) aisle between parking bays and converting them to angle parking to facilitate the development of one-way traffic. Parallel to the car park is a parallel parking area for RVs, designed to comfortably fit five long vehicle set-ups.

Given the self-contained nature of most RVS, it is suggested there is not the need to provide power, although access to a water filling station could be useful (noting the cost of caravanners filling water tanks and the potential for the installation of a paid water station (for example, Karratha Visitor Centre has such an arrangement). The area offers the benefits of proximity to the public toilets, Visitor Centre and the attractions of the CBD. Signage outlining attractions within the immediate area and wider Shire, and options for overnight, or long, stopping could be erected.

6.2 Northam Short-Stay Area

Based on the topography of the area, it is recommended that the most suitable area to locate a short-stay area is directly behind the old Northam Swimming Pool precinct off Mitchell Avenue. As presented in A103, the design has been created to take advantage of the flat area that has been used in the past as a caravan park so minimal earthworks would be required, rather development could be limited to some basic landscaping and gravel road and bay construction.

The location of the bays is aligned with the existing leech drains which would facilitate the installation of grey water drainage outlets at each bay to avoid visitors discharge their grey water on to the ground, which would be an issue given the proximity to the river as well as being unsightly. It is suggested that there is no requirement for ablutions, power or water as many RVs are fully self-contained and that RVs without this capacity would need to utilise the services of a local caravan park.

In designing the park, consideration has been given to creating a layout that allows for drive through bays (attractive to caravaners with larger vans or motor homes) that offer a good degree of privacy with natural plantings around each site. Drive through bays also reduce the risk of injury resulting from reversing vehicles.

6.3 Bakers Hill Short-Stay Area

The Bakers Hill site is proposed for the disused railway reserve running parallel to Newman Street. The site plan is defined in A101, with bays for seven RVs in parallel alignment, allowing for views of the valley and protection from road noise by the gentle slope between the short-stay area and the highway. It is suggested that minimal earthworks are required, with just the modification of the entry and exit for ease of access and grading of the existing roadway. The delineation of bays could be achieved with basic landscaping. Drawing A102 highlights the sizing of bays and proposed vehicle movements.

It is suggested that RV visitors should be fully self-contained to use this area, with no power, water or ablutions (other than existing nearby public toilets) be developed. Consideration could be given to grey water discharge drains to minimise the impact of RVs without grey water capture systems who may use the area.

7 Case Studies

7.1 Case Study 1 – Bunbury Free Rest Areas

The City of Bunbury has responded to the growing trend of RV users seeking free or low-cost camping areas by implementing a trial of three free overnight rest areas, beginning on 1 November 2018. A fully self-contained RV may obtain a permit from the Bunbury Visitors Centre to stay in one of the free rest areas for up to 48 hours. The vehicle must satisfy certain

criteria in order to qualify as fully self-contained, including onboard facilities such as toilets and sinks, which are required to be plumbed-in. If the RV did not satisfy these requirements, the visitor would need to utilise alternative accommodation options such as a caravan park.

The free rest areas are located at Wyalup-Rocky Point (maximum of four vehicles at any time), Ocean Drive at Scott Street (five vehicles permitted at any time), and Maidens Reserve (two vehicles permitted at any time). Sleeping in tents or cars is not permitted at these rest areas. Vehicles must obtain a permit at the Visitors Centre, or if arriving after hours, a staff member visits the sites to distribute permits.

All visitors who use the rest areas are asked to complete a short survey about their stay. Most visitors opted to stay the two nights that are allowed, and spent the most money in Bunbury on fuel, groceries and eating out. The majority learned of the free rest areas online or via an app, with only 21% finding out about them via word of mouth.

There has been increased visitation and spending in the City of Bunbury since the beginning of the trial. A six-month review recently conducted into the trial has revealed that has injected more than \$122,000 into the local economy via the 472 permits that had been issued at that time. This reflected an average spend of \$258.53 per vehicle.⁵

The City of Bunbury recognises that some of the RV community prefer to use free rest areas for one or two nights rather than stay at a caravan park, and that there was a chance that significant numbers of visitors might be bypassing Bunbury due to existing accommodation options. The trial is intended to run for a period of two years. The City will be monitoring the impact and benefits of the free rest areas, which are being actively promoted, and are being careful to not directly compete with commercial caravan park owners. For instance, they are not providing facilities specifically for travellers who use the rest areas. However, the City is exploring options for a free dump point in order to achieve RV Friendly town status.

If the trial is to receive negative feedback from the community or cause issues with City resources, it will be reviewed, reduced or concluded.

7.2 Case Study 2 – Shire of York RV Facilities

CreativeIQ conducted phone interviews with a number of Shire of York representatives who perform roles related to, or impacted by, the free RV rest stops located within the shire.

There are currently two free 24-hour RV rest stops in the Shire, one at Avon Park and the other at Gwambygine. Permits are not required to stay at either of the rest stops, but

⁵ <http://bunbury.wa.gov.au/Pages/Overnight-Rest-Areas-provide-economic-and-tourism-boon-to-the-City.aspx>

vehicles must be fully self-contained and periodic checks are performed by the Shire's ranger service.

The ranger supervises the site on weekdays (and reports monthly data back to council) as well as weekends when there is an event being held, such as the motorcycle festival. The ranger will also check that visitors are not staying beyond the allowed 24 hours, however if there is a genuine need to stay longer, such as having a vehicle or equipment in town for repair or health reasons, extra time is allowed.

Currently, the Avon Park facility has four powered stations, a dump point and toilets, however the new facility relocated over the river will not have free power. Visitors can stay up to 24 hours, provided their vehicle is fully self-contained, and make use of the free power, toilets, bitumen car bay and gas barbeque. The town centre is approximately a five-minute walk from the site.

The second free 24-hour rest stop is located at Gwambygine Park and was set up mainly so that fatigued drivers would have a place to stop and rest, but camping is allowed there. The facility is 11 kilometres south of York on way to Beverly. The facility has toilets, which are cleaned by the Shire, but only semi-regularly. This rest stop is commonly used by visitors travelling with pets.

The Gwambygine Park facility was developed with grant funds and includes heritage interpretive plinths (former school site of historical significance), boardwalk and viewing tower which are currently in disrepair with no current plan for restoration. The site also used to be a frequented wildflower area but now is significantly impacted by weeds.

These free rest stops have been in operation for approximately six years, although it is unknown how long they were unofficially used for this purpose. The Shire of York has had RV Friendly Town status since 2013.

York's RV rest stops evolved through the need for caravan and camping facilities in the township at a time when there was not caravan park options and later when the caravan park within the townsite was not always operation. Since then, business stimulation has resulted in two caravan parks opening in the Shire. Although there has been some contention locally as to whether the free service detracts from the local caravan park business, Shire representatives felt that the RV tourists who use the free sites mainly consist of those passing through on their way to popular destinations, such as the Pinnacles and Wave Rock. The intention of the facility is to increase visitor numbers to support local businesses and data collected supports this. Feedback left at the Visitors Centre includes comments such as, 'We wouldn't have stopped but saw that it was a free and well looked after facility.'

Ultimately, community and local business feedback has led to the Shire to decide to reduce its level of amenity at both rest stops, as well as to move the Avon Park facility over the river

to free up the current site to be used as parkland once again. According to Shire representatives, the relocation is due to the site being subject to a newly adopted redevelopment plan. The relocated facility was intended to be open around July 2018, however the predicted completion date is now more likely to be toward end of 2019.

The new site will have a reduced level of amenity, especially when compared to Avon Park; there will be no power, an unsealed surface, and a dump point. The designated RV location will be separate to the current playground and Avon Park facilities, whilst still maintaining close connectivity to the main street businesses.

Shire of York representatives say that the rest stops have definitely increased visitor numbers to the town, as noted by an increase in numbers to the Visitors Centre⁶. One observation was that there have been higher numbers of visitors from the 'grey nomad' market (55+ years) staying within the CBD for longer durations (for instance, staying at one free rest stop then moving on to the other, as opposed to travelling through town to other rest stops outside the York region). In 2018/19, there were 798 nights' stay at the Avon Park facility and 147 nights' stay at the Gawmbygine facility.

The Shire employees interviewed felt that the increase in visitors since the free service started has been largely due to word of mouth among these grey nomads, who have spread the word on the quality of the facility and recommended it. The site is registered on websites such as wikicamps.com.au and tripadvisor.com.au and has been given popular reviews which help bring in visitors who make use of social media and the internet. It has, however, been noted that there is misinformation provided on some of these websites.

Benefits noted from the increased number of visitors to the Shire include anecdotal reports from businesses in proximity to Avon Park facility reporting higher turnovers; an increase in volunteers for festival period activities; and a reduction in vandalism to Avon Park due to increase in passive surveillance (the increased presence of people and vehicles at the park). The low cost of providing power, and the low maintenance requirements for the service, are offset by the benefits the service provides to local businesses.

Challenges noted in managing and maintaining the facilities include community concerns regarding the number and frequency of caravans parked at the playground at Avon Park; the increase in use of Avon Park due to level of amenity offered for RVs (these issues should

⁶ Metrics for both sites are taken by the ranger on week days and reported to Council. Additionally, about 12 months ago, the Visitors Centre was fitted with an automated door counter and prior to this, manual counting was undertaken and recorded in annual reports available online. As a result of increase in Visitors Centre customers, a grant was awarded, and more staff have been hired to allow the centre's hours to be increased.

be resolved with the opening of the new facility); and concerns from local caravan parks due to the perception that council is in direct competition with them. Again, the reduced amenities that will be offered at the free rest stops may address this contention.

Overall the impact on the community has been largely beneficial, in particular through the higher volume of visitors, who might otherwise pass by, instead staying for a day or two and using town facilities, which supports local businesses. The unexpected benefit of 'passive surveillance' has made an impression on Shire representatives, as depending on the location of the rest stop it has the potential to reduce occurrence of graffiti and damage to adjacent parkland and equipment.

Suggestions from the Shire of York, based on their experiences in offering and maintaining the two free rest stops, are that websites such as Wikicamps and Trip Advisor can be administered and utilised by the local government as a feedback loop about the service and also should be monitored for misinformation. The Shire also advises that it is beneficial to have a conversation early between local government and existing local camping/caravan facilities to look at opportunities to work together for the benefit of both facilities, e.g. a promotional flyer distributed by the ranger to those who wish to stay longer. It is important to ensure the intention of the service is clearly defined.

7.3 Case Study Three – 'Experience' Caravan Parks

Caravan parks that are not located near tourist hot spots need to offer more than a place to park for the night to attract visitors. No longer are RV users willing to pay to stay at locations that do not offer benefits beyond basic amenities as vehicles are so well equipped now that many can go several days (or longer) completely off grid.

Despite not being located at a traditionally popular tourist location, many regional caravan parks are well-patronised because visitors are willing to travel in order to enjoy the experiences that the caravan park offers.

Willow Brook Farm Caravan Park is located just outside of Gingin. Although only a thirty-minute drive to the nearest beach, it is definitely not a beachside caravan park and does not strongly market this attraction. Rather it focuses on attracting visitors who are keen for a relaxed, farm experience. Besides from having good standard amenities, the park features a range of farm animals (included a daily 'afternoon round-up' where children can pet the animals), complimentary Sunday scones (a popular event with visitors) and a communal fire pit which is well-frequented by guests. Rather than relying on external attractions, Willow Brook have developed their park as a place to visit and experience, rather than simply a place to sleep at night.

Another Wheatbelt caravan park seeking to attract visitors for an experience is White Gum Farm. This enterprise is based just outside of York and combines a caravan park with a small airfield. Like Willowbrook, it has good standard amenities. It leverages the bush setting with

walking trails along with fishing and swimming in the man-made stocked lake. It also integrates the park with the airfield, with visitors able to watch take offs and landings or even take a joy flight. The park is also set up for day use visitors, particularly at the lake and 4WD park adjacent to the caravan park area.

The Shire of Quairading operates the local caravan park and, despite its relatively remote location from Perth and limited local attractions, it is well-patronised. Asides from having a very well-presented park with good amenities, the local government has taken an approach of specifically targeting caravan clubs to visit. Asides from marketing the local attractions, the clubs are assisted to book group meals at local venues and local businesses are alerted to their travel plans to allow them to vary their opening hours to take advantage of trading opportunities. The park is set up to allow for groups to gather and participate in activities, making it an attractive option for clubs.

8 Analysis of Potential Benefits

A formal cost-benefit analysis was not within the scope of work of this study as the cost of the preparation of this element would be considerable and is unlikely to significantly alter the overall findings of this study.

This study does however look at the anticipated economic, environmental and social benefits of this initiative in broad terms. In terms of more quantifiable economic impact, it is difficult to precisely anticipate this as there is insufficient market research to understand the number of visitors who currently do not visit Northam at all due to a lack of formal RV parking facilities. It is also not known as to the number who visit but have a limited stay owing to a lack of formal RV parking facilities compared to the number who would visit if there were RV day site facilities. Nor is there knowledge of the number who would not consider staying at a caravan park but would stay at a free or low cost overnight stopping facility.

On the basis that the Shire of York saw 798 nights' stay at the overnight stopping facility in their townsite in 2018/19, and data from City of Bunbury finding visitors to their free camping facilities spent around \$258 (assuming they stayed the maximum two nights allowed, thus being around \$130/night) we have made some assumptions around potential direct economic benefits of this type of visitation. If Northam was to capture a similar number of annual stays as York and we make an assumption that visitors might spend slightly less in Northam than Bunbury as there are less paid attractions to visit, that is something in the order of \$80,000 additional spend in the town on an annual basis. Whether those visitors would have stayed at one of the caravan park options is difficult to determine, however trends show that those people using free camping options often tend to avoid caravan parks.

8.1 Economic Benefits

MARKET SEGMENTATION

A report prepared for Tourism WA in 2012 segmented the caravan and camping tourism market into:

- Family groups
- Grey Nomads
- Backpackers and budget travellers
- Experiential travellers
- Short break and weekend holiday makers; and
- Owners of holiday sited caravans on caravan parks⁷.

Since this time a differentiation has become common in caravanning literature between 'grey nomads', who travel for extended periods and often to avoid winter in the southern parts of Australia, versus 'grey caravanners'¹⁰, who take short trips up to three days and often are still in the workforce.

TOURISM EXPENDITURE

The main potential economic benefits of caravan parks and camping grounds are direct expenditure by tourists, with indirect benefits to employment⁸. However, these benefits are difficult to quantify in smaller, regional locations and therefore prone to generalised or inflated statements of benefits.

In 2009 the Campervan and Motorhome Club of Australia Ltd (CMCCA) made a submission to the Standing Committee Inquiry into the Provision, Use and Regulation of Caravan Parks and Camping Grounds in Western Australia, stating travellers in self-contained vehicles spend reasonable sums on their visits to towns, particularly towns with "one good-sized supermarket, a reasonable range of other shops and services, and facilities for vehicle parts and vehicle servicing"⁹.

However, during its investigative travel the Committee also heard "considerable and consistent evidence that travellers go to some length to reduce their expenditure and in

⁷ Tourism WA. (2012) A Strategic Approach to Caravan & Camping Tourism in Western Australia. Prepared for Tourism WA.
https://www.tourism.wa.gov.au/Publications%20Library/Industry%20Support%20and%20Opportunities/The_Brighthouse_report_June_2012_v2.pdf

⁸ Campervan and Motorhome Club of Australia Ltd. Nd Self-Contained Travellers*. Available at: http://www.cmca.net.au/pages/about/government/economic_benefits/index.php. Accessed on 15 June 2009. *The methodology and timing of this survey is not known, however it is assumed that it is a small survey of members at a rally in the early 2000s, similar to that undertaken in April 2009.

doing so reduce any economic benefit they bring to a community⁹. They concluded that while caravan parks, camping grounds and facilities such as supermarkets and petrol stations do provide employment, the anticipated or implied flow-on effect of these traveller's spend to the local community may be often overestimated⁹.

Nevertheless, a Queensland Parliamentary Report in 2011 concluded the travel behaviour of grey caravanners (older short stay travellers) could be crucial to the economic survival of many small rural and regional destinations throughout Australia¹⁰. With low population densities and lack of economic diversification tourism can be an important economic contributor in regional areas, but generally has a nature-based focus¹¹. Abundant space and natural environments are drawcards for the emerging trend of outdoor recreation in WA¹², with the Shire of Northam able to fulfil both areas with close proximity to Perth. This also fits with existing RV research showing outdoor leisure is a focus of travel and may be an important consideration for both the type of facilities offered and the areas of likely expenditure.

A study comparing Exmouth, Coral Bay, Cape Range and stations camping found the type of accommodation used by tourists has a significant influence on the costs and benefits to the region¹¹. Although the campers had comparable incomes to those using town-based accommodation facilities, those camping made lower spends in all categories except fuel and the study concluded they were a net cost to the local economy because of their low direct spending, the lack on indirect contribution via formal accommodation (e.g. rates), the cost of dealing with environmental impacts and maintaining local roads and infrastructure¹¹.

There were increased economic benefits associated with presence of services and infrastructure (motels, restaurants, retail outlets) that require or encourage visitor spending. This translated to an average daily spend of \$142 in Exmouth, versus \$44 camping, with the Exmouth figure likely inflated by the whale shark activities which costs \$300 per experience⁵.

The most recent data from Tourism Research Australia in 2013 shows cost was a significant factor for those travelling self-contained, with 45% of respondents saying they travelled

⁹ Economics and Industry Standing Committee. (2009) Provision, Use and Regulation of Caravan Parks (and Camping Grounds) in Western Australia.

[http://www.parliament.wa.gov.au/parliament/commit.nsf/\(Report+Lookup+by+Com+ID\)/3AA6B1AE956E1C9C48257831003E97FE/\\$file/Part+2+AS+ADOPTED.CCI+-+Provision,+Use+and+Regula.pdf](http://www.parliament.wa.gov.au/parliament/commit.nsf/(Report+Lookup+by+Com+ID)/3AA6B1AE956E1C9C48257831003E97FE/$file/Part+2+AS+ADOPTED.CCI+-+Provision,+Use+and+Regula.pdf)

¹⁰ Patterson, I, Pegg, S, Mahadevan, R. (2015) *The Benefits of Short Stay Caravan Travel Based on the Lived Experiences of Grey Nomad Caravanners in Australia*. Tourism Analysis, Vol. 20, pp. 539-549 1083-5423/15

¹¹ David Wood & Michael Hughes (2006) *Tourism accommodation and economic contribution on the Ningaloo Coast of Western Australia*. Tourism and Hospitality Planning & Development, 3:2, 77-88, DOI: 10.1080/14790530600938212

¹² Tourism Western Australia (2015) *Tourism Western Australia: Fast Facts Year Ending June 2015*, Perth, Western Australia; Government of Western Australia.

that way because it was cheap. The majority of respondents reported using rubbish facilities, overnight and day rest bays, free sewerage dump facilities and potable water but few reported using 'pay-to-use' sewerage dump facilities and vehicle wash down bays. Just over half (55%) said they would not be willing to pay anything for overnight rest bays and 84% would not be willing to pay anything for roadside rest bays. Two-thirds would be willing to pay for sewerage dump but only willing to pay on average \$3.55¹³.

A study of users on the MTM rail trail in Victoria, a multi-use tourism and recreation trail on abandoned railway lines for use by cyclists, walkers and horse riders, found that towns with a range of activities and good marketing enjoyed the highest overnight visitor rates. Caravan and camping were the two most common accommodation types (amongst a mix of available accommodation types) and overall expenditure on accommodation was not high. While a quarter of surveyed visitors spent nothing on food and beverage (assuming they brought supplies with them) many of those spending little on accommodation did have high spends on food and beverages and the Centre for Sustainable Regional Communities at La Trobe University developed conservative multipliers for this project estimating a 2.00 multiplier for retail, 1.81 for accommodation, cafes and restaurants, and 1.77 for cultural and recreational services¹³.

EXISTING FACILITIES

An important consideration in the economic benefits of the caravan and camping sector is the interplay between free camping and self-contained travel facilities and existing caravan parks. Self-contained travellers who only require or want some of the facilities provided at established parks have proven to be an issue for some established providers, who struggle to offer these at a reasonable price (given operating costs) and within their statutory requirements¹⁴.

The Caravan Parks and Camping Grounds Regulations 1997 (WA) was reviewed in 2014 with the consultation stating that the increase in self-contained recreational vehicles (RVs) that do not need the same facilities prescribed in the Act was stifling the ability of caravan park operators to respond to different market segments¹⁴. The Department of Local Government removed regulation 49 as this was found by the National Competition Policy review to be anti-competitive.

The Shire of Northam currently has no official free camping areas within the local government area, although there are known to be a number of locations where overnight stays do occur. A number of WA local governments offer land (often Crown Reserves and showgrounds) for regular overnight camping and many of are not required to comply with

¹³ Tourism Research Australia. (2013). Evaluating the Caravan Park and Self-Contained Traveller Sector in Western Australia.

¹⁴ DLGC (2014). *Consultation Paper: Proposal for Caravan Parks and Camping Grounds Legislation*. Department of Local Government and Communities. 30 May 2014.

the Caravan Parks and Camping Grounds Regulations 1997 or be subject to a Planning Application^{Error! Bookmark not defined.}. Non-compliant sites are often offered free of charge or at a token fee yet compete against licensed caravan parks which local government inspect and require to comply with statutory regulations. In these cases, Councils may be breaching the competitive neutrality provisions of the National Competition Policy as well as conducting illegal and potentially unsafe operations.

CO-LOCATION AND CLUSTERING

A report for Tourism WA highlighted some existing examples and potential opportunities to co-locate caravan and camping facilities with other tourism facilities to enhance visitor experience and increase capacity where a standalone caravan or camping facility may not be commercially viable in its own right. Examples included⁷:

- Co-locating rest areas and dump points with existing caravan parks and/or roadhouses.
- Allowing limited duration caravan stays and camping at farms, stations, chalets or bed and breakfasts.
- Roadhouses permitted to offer an increased number of caravan or camping sites.
- Aboriginal community caravan or camping sites along with cultural tourism.
- Caravan or camping stays at vineyards, attractions, golf clubs, airports, showgrounds, sport grounds, race-tracks and clubs (special event or limited stays).

Realising the economic benefits of clustering and co-locating would also depend on local business being open, and the success of this can be demonstrated in projects such as the MTM rail trail in Victoria^{Error! Bookmark not defined.}.

REDUCTION IN LOCAL GOVERNMENT COSTS

Supplying facilities for the caravan and camping sector could reduce expenditure on maintenance, cleaning and waste disposal at roadside stops, rest areas, authorised and unauthorised camping areas^{Error! Bookmark not defined.}. These costs are incurred by local government or in some instances State Government agencies such as Main Roads WA.

Even though more formalised facilities such as RV dumps still incur maintenance costs, the usage may be more consistent and therefore easier to plan and budget for, as opposed to reactive maintenance and clean ups of ad hoc hotspots. The success of identified locations in reducing illegal camping would also be dependent on attracting the right market segment.

8.2 Environmental Benefits

Most of the environmental benefits are rather reductions in environmental impacts caused by informal caravanning and camping. The increasing appeal for low-cost, low-facility and

nature-based 'camping' experiences has led to an increase in illegal camping as well as caravanners spending several nights in a town in bush locations then checking into established caravan parks for one night, for example to "have a hot shower, leave rubbish and dump their toilet waste", as described by the York Caravan Park⁹ in their submission to the Economics and Industry Standing Committee in 2009.

Warroora Station in the Coral Coast region described issues with caravans using their dump point and leaving without paying or threatening to unload their waste¹⁰. The Shire of Exmouth reported people camping on the side of the road is a regular occurrence despite plentiful facilities. The Shire of Manjimup made a submission to the Committee¹⁰ detailing how the logistics of monitoring over 3000km of road network to ensure people are not camping for more than 24 hours is impractical. Over time the impact of this type of camping (dependent on camper behaviour) is "accumulation of litter, vegetation removal for camp fires, significant evidence of illegal wastewater disposal and general site deterioration". Feedback from Shire officers in June 2009 indicated the situation was at crisis point and required legislative changes to avoid significant environmental consequences. The Committee made a finding that "allowing unregulated camping is not advisable due to environmental, health and amenity considerations"¹⁰.

There are potential public liability issues for government agencies and local government which knowingly "turn a blind eye" to illegal camping activities that can place the public in danger. Fire risk, accidents between large transport vehicles and recreational vehicles competing for space in the same rest areas, health and security issues are all potential for litigation in the event travellers suffer damage or loss.

Camping is considered a generally high impact activity ecologically as it can result in loss of vegetation cover, soil compaction, erosion, pollution and other issues such as disposal of waste, taking resources as firewood and unregulated access to natural areas.

Among some of the known unofficial sites used by caravanners in the Shire of Northam, Eadine Springs and Wilkinson Park are potential sites that could be at risk from camping or caravanning impacts such as vegetation loss, soil compaction, waste disposal and impact on freshwater sources which provide habitat (e.g. for birds and macroinvertebrates) and ecological services.

Counter to the perception of camping being 'low impact' and 'nature-based' tourism, minimising its impact relies on the provision of suitable infrastructure such as design and supply of sewerage services or more formalised accommodation. In areas of environmental significance, small-scale tourism is usually suggested as the best way to minimise impacts and maximise benefits¹¹. However, numbers play only one role, with management of development and the type of activities undertaken equally important.

The State Government has produced 'Nature Based Parks licensing guidelines for developers and local governments' which outlines requirements for developing a nature-

based park on a Crown reserve, unallocated Crown land (UCL). As a guide, the operator is required to prepare a Management Plan addressing:

- (a) market segment being targeted;
- (b) amenities proposed to be provided, or not provided (in light of the market);
- (c) site planning;
- (d) environmental impact and sustainability;
- (e) waste management;
- (f) traffic management;
- (g) risk management; and
- (h) length of stay of occupiers.

The guide explains that assessment of Management Plans is flexible to focus on the intended market segment for the park and type of facilities required, balanced with environmental sustainability¹⁵.

8.3 Social Benefits

Most of the social benefits associated with camping or caravanning are received by the tourist and include the general benefits associated with taking a holiday, facilitation of recreation and learning opportunities as part of travel, and as an affordable alternative to other accommodation. Research on 'grey caravanners' (as opposed to grey nomads), a growing niche of the caravan market, has shown they have a strong preference for shorter trips and are often members of a caravan club. For this segment the communal atmosphere and the opportunity to meet new people and socialise appear to be key motives for travelling by caravan³.

The RV Friendly Town concept signals to RV tourists that they will be welcome there, that certain services will be provided for them, and that they have a safe place to stay for the night, or longer. All of this depends on the support of the local community. Furthermore, part of the tourism 'product' itself is the local community, as they are integral to the unique 'character' of a place that attracts tourists, particularly those who have travelled from some distance.

Social Political and Cultural Capital (or SPCC) is a social capital concept that brings the local community into the process of developing tourism and is particularly important in regional areas. Tourism development can be generated from within communities and it has been argued that communities which lack SPCC will not be able to sustain long-term tourism

¹⁵ DLGC. (2014) *Nature Based Parks Guidelines*. Department of Local Government and Communities. December 2014. Accessed from: www.dlgsc.wa.gov.au/resources/publications/Publications/Nature%20Based%20Parks%20Guidelines/NatureBasedParksGuidelines.docx

markets, therefore this element should be given significant consideration alongside the economic costs and benefits¹⁶.

The position of community members towards various tourism ideas (e.g. from support to antagonism) is important in planning and development and could promote or undermine the success of various ventures. Tourism can in turn boost the cultural capital of an area, for example, a community 'gathering' to share a cultural event will contribute to the development of its social capital¹⁶. A local Northam example is the broadening of the local hot air ballooning tourism industry to include the wider community via the Balloon Fiesta and Discovery Zone events.

Community involvement also delivers social benefits, such as the MTM rail trail project in Victoria which concluded that the health and wellbeing of both trail users and the local community are positive benefits from this tourism initiative. The social interaction between these groups can also foster a sense of pride and community identity, learning benefits, meeting like-minded people and bringing 'new faces' into smaller rural communities¹⁶.
Bookmark not defined.

SPCC contributes to a better environment conducive to tourism because high social capital public spaces are cleaner, the people friendlier and the streets safer. However, rather than commodifying social capital, it should be considered how tourism development (including ownership, purchasing and staffing) contributes to the economic well-being of the region. The planning and development should also involve stakeholders such as residents in meaningful ways that contribute to developing the networks that the industry will rely on¹⁶.

9 Recommendations on Site Development

Consult with Northam Caravan Park and Avon Valley Chalets

As a key stakeholder, it is recommended that the Shire of Northam's next step is to consult with the Northam Caravan Park and Avon Valley Chalets owners to better understand their priorities and concerns, looking for opportunities for the Shire to support the sustainability of their business. It would be beneficial for the Shire of Northam to gain an understanding of occupancy rates at the Parks, along with their targets in this area and strategies to achieve these. If the Parks are regularly at capacity or are not able to respond to the requirements of all RV travellers (who are consequentially not visiting or overnighing in the Shire) there may be an opportunity for a Northam-based short-term stopping option.

Consult with Other Stakeholders

¹⁶ Macbeth, J., Carson, D., Northcote, J. (2004) *Social Capital, Tourism and Regional Development: SPCC as a Basis for Innovation and Sustainability*. Current Issues in Tourism Vol. 7, No. 6, 2004

The Shire of Northam may also like to consider consulting with businesses in Northam more broadly to determine the sentiment towards the proposal. Consideration should be given to engaging with the Northam Chamber of Commerce along with retail, service and hospitality businesses who may derive additional trade from a short-term RV stay facility, or businesses who are concerned that the initiative could have a negative impact on their business in some way.

Development of RV Day Site – Northam

It is recommended that the first priority for development should be an RV Day Site in Northam to meet the need for a designated parking option for RVs.

If the Shire of Northam is keen to be designated RV Friendly Town as a matter of urgency, consideration could be given to allowing 24-hour stopping at this location with the proviso that visitors are fully self-contained including grey water capture.

As an alternative to qualifying as an RV Friendly Town, Shire of Northam might instead consider a marketing campaign targeting RV travellers and highlighting the opportunities for them locally rather than seeking the RV Friendly Town brand endorsement.

Undertake Market Research

To better understand the needs and behaviour of RV visitors to the area, and to measure the current and potential benefit of this sector to the local economy, it is recommended that the Shire of Northam seek more detailed, formal feedback from visitors (akin to the data collected by City of Bunbury as part of their RV parking trial).

Development of RV Traveller Marketing Campaign

There is the opportunity to develop a marketing campaign directly targeting RV travellers highlighting stopping options around the Shire, along with attractions. This could combine online marketing (website information and paid social media campaigns) with printed marketing collateral and signage (directional and informational). Updating Wikicamps with information about points of interest and caravan sites would also be useful. An educational approach should be taken to encourage visitors not to camp at non-designated locations to minimise environmental impact, lessen risk to visitors (safety and injury) and avoid public health issues around discharge of waste water.

Development of RV Caravan Parks – Bakers Hill and Wundowie

It is recommended that the Shire of Northam allocate funding to respond to community aspirations identified in the Bakers Hill and Wundowie Community Plans to establish RV stopping options in their townsites as a means to improve visitation and spending. Following the development of the parks, an application to have the towns designated as RV Friendly should be made.

It is suggested that in first instance, local businesses/individuals be offered the opportunity to undertake the caretaking of the sites on a contractual basis as a means of supporting the local economy. Where a suitable provider of caretaking services cannot be found, then this could be undertaken as part of Shire of Northam operations.

Development of RV Short-Stay Area - Northam

Subject to the confirmation of need (based on consultation with Northam Caravan Park and surveying of RV visitors) develop an RV Short-Stay area in Northam with a view to providing a limited amenity short-stay option for self-contained vehicles (although as per concept designs, it is recommended that grey-water disposal is provided to minimise public and environmental health risks).

If a short-stay area is developed, it is recommended that the Northam Caravan Park be offered the opportunity to undertake the caretaking of the sites on a contractual basis in acknowledgement that this is their field of expertise and as a way for them to build rapport with site users to potentially extend their stay and relocate to the Northam Caravan Park. If the Northam Caravan Park is not interested in this opportunity, then this could be undertaken as part of Shire of Northam operations or contracted to another local business or individual.

UNCONFIRMED

Appendix – Excerpts from Wundowie Feasibility Study

The following elements are taken directly from Wundowie Community Hub Feasibility Study prepared for the Shire of Northam in May 2019 which include the development of options for a short stay caravan park. These excerpts should be considered in context with the rest of this study which looks at the underpinning community planning documents and stakeholder engagement in relation to these projects.

Benchmarking – Similar Facilities

BINDOON TRANSIT PARK

Bindoon Transit Park is small, basic facility with six powered bays that have gravel pads. There is a dump site for waste on the site, as well as toilets and showers, but there is no kitchen or laundry available for campers.

The Park is managed by the post office on behalf of the Shire of Chittering and post office staff member, Kristy, provided some insights into operations. The post office manages the park because they are open every day, whereas the tourist centre is not.

The park is mostly self-managed meaning that they often run off an honour system. If the post office is open when visitors arrive, they can come in and pay the \$20 for the night and pick up an information pack. If the post office is not open there is a sign out the front instructing people to leave their \$20 in the box out the front. Kristy feels that this system works very well but admits there often isn't any way of telling how often people abuse it. She feels most people are generally honest and the majority do come and go during business hours. There are also signs in the public toilets informing visitors of how the honour system works. Although the system is casual, Kristy feels it is pretty clear to visitors what the expectation of them is and they do not have any plans to change the approach as it is working well.



They do not keep records of things like car or caravan registration, but they do record where people come from and how long they stay for the tourist centre.

Although quite basic, the park is appreciated by visitors and is quite well utilised. Kristy believes it definitely improves visitation to the town. January and February are usually the quietest months but this year they have had at least 1-2 people in there each day, on average staying for about 4 nights a week. This is busier than usual at this time of year, Kristy thinks it might be because people are less worried about the heat because more people have better caravans with good air conditioning.

Tourist season is the busiest and usually runs from winter to spring and into the start of summer. During this period the park will be full every day and they need to remind people to leave by 10am because there will be more people arriving later in the day. There is no option to pre-book a site which may put some people off planning a stopover as there are no other options in the Shire and its possible they prefer an option where they can be certain of obtaining a bay, especially if they have had a long day of travelling.

She also said that as Swan Valley becomes more popular, they are getting the overflow. The area has had access to camping facilities for a long time, but the transit park has been there for about 4 years. It is good for the town as the visitors who stay patronise local businesses such as IGA, the pub and bakery.

Charges

\$20 per night for two people, max. 4-night stay

QUAIRADING CARAVAN PARK

Quairading Caravan Park was completely gutted out and revamped about three years ago. It used to be more 'traditional' style with lines of bays but is now a sort of 'wonky roundabout shape' with two large bays at the front for 'drive throughs' that are only staying one night or very big vans; a section in the middle of the 'roundabout' that has concrete bays plus a kitchen, laundry and male and female toilets, a fire pit and seating area; and the back area which has bigger bays with gravel pads for longer stays. These are for vans staying more than a week, to a maximum of two months. There are around 20 bays in total. There is also an overflow area if the park is full.

There is no dump site in the actual park, the dump site is situated on the outskirts of town so it can be accessed by vans that are not staying at the park.

The Shire of Quairading officer, Michelle, who was interviewed for this study advised that the park receives very positive reviews particularly in relation to neatness and effectiveness of the set up. She also said their best asset is the amazing caretaker. Her observation was that it does not matter how nice the park is, if you don't have a good caretaker then it doesn't matter because the facilities are not taken care of well and visitors do not have the same positive experience.



When asked about management of the site such as taking bookings and payments, Michelle said they are actually talking about changing their process completely as their current system does not work effectively.

Any bookings or payments are done through the Shire, but it is only open Monday – Friday. If there are visitors on weekend or arriving after hours, they have the option to pay cash to caretaker, but he doesn't take any names or numbers, so they have no record of who has been there (the Shire usually has a diary of bookings). The caretaker is also not constantly in attendance. If guests arrive at night, the caretaker will take their payment in the morning.

The Shire also has no way of allocating bays to particular people and will not be aware of which guests are in which bays. They are unsure yet of how their processes will change and in fact are planning on exploring what other Shires do for their facilities.

In terms of utilisation, Michelle said it is well utilised and that a fair amount of their business comes from caravan clubs who often book up to 12 months in advance. They will often have one every month, each club might have 15-20 vans. The clubs provide repeat business and keep coming back not so much because there is a lot to do in the town, but because the park is very nice and provides a spot to relax.

The park does also get quite a lot of drive throughs (one-night stay) of vans stopping en route to Perth. Quairading also holds a community event once a year – a community camp out, and a lot of the locals will stay in the caravan park on this night, just in tents and swags.

They do experience quieter periods, such as immediately after school holidays, but it is usually on and off with no real pattern.

Michelle thinks that the revamped park has improved visitation to Quairading, with the improvements being a big part of it. The park was 'pretty ordinary' before but now that it is nicer people are returning – people are always commenting on how nice the park is.

Also, if the Shire gets a big booking – like a caravan club, they will inform the Community Resource Centre who will put a notice in their newsletter to inform local businesses. If a club is coming some businesses (such as the IGA) that are not usually open on weekends might open for a couple of hours on a Saturday to accommodate the extra people. The pub needs the notice that it might need to serve 20+ extra meals during that period so they appreciate the advanced notice.

Charges

Powered Caravan Site - 2 persons - \$30/night (stay four - pay for three)

Caravan Clubs - \$28.50/night

Cottage Charges (\$200 bond applies)

1 night - \$125; 2 nights - \$118/night

KOORDA CARAVAN PARK

Koorda Caravan Park is a long-established park, with old and very basic facilities but that are always kept very clean and tidy. The Shire hires cleaners who clean the park every day. The Shire of Koorda officer, Debbie, who was interviewed for this study, identified the most important feature of the park as its clean, tidy facilities.

The site has one dump site located in the park. There are approximately 20 powered sites with dirt or gravel pads. There is also room for other vans around the outside area, but these are unpowered sites. There is also a lockable unisex toilet/shower room with access ramp, separate men's and ladies' bathrooms, scheme water, undercover camper's kitchen with electric BBQ facilities, and a pay-per-use washing machine with clothesline. Generators are allowed so long as they don't disturb other campers, pets are also allowed but must be on a leash at all times.

As previously mentioned, the Shire hires cleaners who clean the site every day, they also take money and bookings during office hours. After hours and on weekends, payments are managed via an Honesty Box. Debbie said there are no real issues with the honesty box, both in terms of theft and people using the site but not paying. If people stay longer, they will usually pay at the Shire office. There are envelopes available for campers to leave their payment in for the Honesty Box, this includes space for their name and other details, which are recorded by Shire staff on a spreadsheet and kept for tourism purposes.



The caravan park is quite well utilised, especially during Wildflower Season. The hottest months tend to be the quietest time. Debbie says despite being quite old, the park has improved visitation to Koorda, especially since the Wheatbelt Way was improved. They also get visitors through word of mouth as their facilities are so clean and well-maintained.

One difference to many other parks is they do not have any self-contained units for people to stay in – it is just a caravan site with powered and unpowered sites. There are self-contained units in the town but not at the caravan park.

Koorda also has a drive-in movie theatre (opened in 1965, closed briefly in the 1980s, then renovated in the 1990s), owned by the Shire and operated by the Community Resource Centre (with the canteen run by community groups as a fundraiser), that screens a double feature once a month. Prices are \$12 per adult, \$6 per child, with under 3s free. It was updated to a digital system in 2015 with a 20x22 metre screen. Koorda is one of three drive-in cinemas still operating in Western Australia. It has a capacity for 110 cars. The presence of both the drive-in theatre and the caravan park in the one town means that visitors from other areas are attracted as they can watch the features, have dinner at the canteen and have an inexpensive but comfortable place to stay overnight.



Charges

Caravans per night \$27.00

Caravans per week \$110.00

Non-powered Site \$11.00

Tents per night \$6.00

CARAVAN PARK FACILITIES - DISCUSSION

The most important feature of the parks reviewed was their presentation and maintenance. Each varied in terms of size and level of amenity but all ranked having a very clean and well-maintained facility as being very important to maintain visitor numbers.

Each park clearly made a positive difference to the local economy in varying ways - in Quairading with the leveraging of caravan club visits, in Koorda through the added attraction of the drive-in cinema and in Bindoon by capitalising on their proximity to the Swan Valley. All locations considered that the caravan parks provided extra income for businesses in town, making them more viable.

At a minimum, sites with power and water, an amenities block (although not necessarily with laundry features if the site was not staffed) and a dump point were required to service visitors. The honesty system seemed to work well for payment. Having a fair number of bays (20) made the two larger parks an attractive option for caravan clubs.

Overview of Requirements – Un-Manned Caravan Park

A basic, short-stay caravan park should incorporate the following facilities as a minimum:

- Bays with either grass or gravel sites (with concrete pad if achievement within budget), ideally serviced with power and water. Bays should be easy to reverse a 22ft caravan into, with drive through bays if space permits.
- Basic ablution block with accessible toilets and showers.
- Dump point.
- Sheltered communal area, with gas BBQ and basic kitchen (sink and bench space) if budget permits.
- Information bay (potentially incorporated into communal area).

Overview of Concept Designs – Caravan Park

Based on the topography of the area, it is recommended that the most suitable area to locate a caravan park would be where the current lower hockey field is. As presented in SK101, the design has been created to avoid encroaching on the remaining hockey field but in close enough proximity that it could be used for overflow caravan or tent sites if the park was at capacity during an event or a visit from a caravan club.

In designing the park, consideration has been given to creating a layout that allows for drive through bays (attractive to caravaners with larger vans or motor homes) that offer a good degree of privacy with natural plantings around each site.

A modest ablution block and drive-through dump point is situated at the hockey field end of the park to allow for easy access by visitors using the overflow area and with the potential for the toilets to be used by players and spectators at sporting events on the field.

Management Models and Revenue Generation

There are a few options open to the Shire of Northam, including:

1. **Local Government Management** – Shire of Northam assumes total responsibility for the management and operation of the facility, including collection of fees, cleaning, promotion and maintenance. This gives the highest level of control to the Shire of Northam but may not be operationally convenient.
2. **Contract Management** – An individual, community organisation or commercial entity is contracted to operate all or part of the facility under a detailed contractual arrangement. This would see the Shire of Northam paying a third party to manage operations while retaining responsibility for the maintenance of the building and capital equipment. The Shire would play no role in day-to-day operations but could require the contractor to adhere to strict principles about how services are delivered. There is a risk that poor management could result in the Shire

shouldering the burden of a third-party's poor financial decision making or dissatisfaction from service users and/or the community about the services provided.

- 3. Lease** - The Shire could lease the facility to a third party to operate the park. This would see a third party able to operate the facility independently, without involvement from the Shire and would limit the Shire's responsibility for financial decisions taken by the lessee. However, it would also significantly reduce the Shire's ability to influence the operations of the facility. Given the small park size, it seems unlikely that a commercial entity would be interested in leasing the park even if they were provided very favourable terms.

Some other considerations could be the use of technological solutions for payment – for example credit card payment via a website could be established (and cheaper rates offered to visitors paying by credit card offered) to minimise the number of cash payments needing to be received. The adoption of such a method could result in the only management of the park on a day-to-day basis being cleaning and general maintenance. To minimise issues around vandalism, a key pad system could be used – the City of Busselton has an automated phone system where travellers wanting to use the dump point to call and provide some identifying information before being provided with a code to deactivate the dump point lock.

Potentially the caravan park offers the opportunity to allow a local individual or existing business to develop a tourism product (tours or other experiences for example) and being contracted to manage the caravan park could provide an additional income stream to make the business more viable (and incentivise them to ensure the visitor experience at the park was of a high standard to increase visitation).

Benefits – Short-Stay (Un-Manned) Caravan Park

Given the relatively low average income in Wundowie compared to Western Australia, a significant way to provide economic benefit is by attracting outside visitors to the town.

ECONOMIC BENEFITS

The focus of a short-stay caravan park would be economic benefits from attracting visitors, with some flow on of social benefits to local residents. Tourism in regional Australia is a significant economic contributor and generally has a nature-based focus¹⁷. Outdoor recreation is an emerging trend identified in WA and abundant space and natural

¹⁷ David Wood & Michael Hughes (2006) Tourism accommodation and economic contribution on the Ningaloo Coast of Western Australia. Tourism and Hospitality Planning & Development, 3:2, 77-88, DOI: 10.1080/14790530600938212

environments are seen as drawcards¹⁸, with the western ward of the Shire abundant in both of these plus close proximity to Perth.

The economic benefits of nature-based tourism are two-fold: primary tourism spend within the region on user fees, accommodation, equipment, food and fuel; and secondary employment and income expenditure. Economic multipliers are usually inaccurate at such as small scale however direct spend estimates can be used. The mean daily direct spend measured at several sites in WA is shown below¹⁷:

Item	Exmouth	Coral Bay	Cape Range	Stations
Local travel	\$15.50	\$43.10	\$12.90	\$16.40
Accommodation	\$41.22	\$16.10	\$11.10	\$6.00
Food/drinks	\$46.58	\$12.20	\$10.30	\$7.50
Activities	\$34.84	\$19.00	\$6.90	\$11.20
Equipment	\$3.88	\$5.50	\$4.90	\$2.90
Total	\$142.02	\$95.90	\$46.10	\$44.00

A study of Exmouth, Coral Bay, Cape Range and stations camping showed a higher direct tourist spend in Exmouth and Coral Bay was directly related to the existence of facilities, services and infrastructure that require or encourage spending. Furthermore, although the visitors had comparable incomes to those using town-based facilities, those camping made lower spends in all categories except travel (e.g. fuel), and were actually found to be a cost to the local economy rather than a net benefit as they used local services such as roads (maintained by the local government) but did not contribute in the way formal accommodation does¹⁷.

This is important to consider in the context of Wundowie as it does not have an existing tourism product to draw on and, other than the Iron Festival, no strong pull factors for visitors. As an economic driver, there are limitations to the festivals and events sector for small towns due to their episodic nature¹⁷. There are also limited opportunities to leverage the buying power of visitors and few tourism spend categories covered, with fuel, accommodation, food/drinks currently largely offered elsewhere in the Shire. There is potential for sufficient caravan park visitors to make enterprises such as a café or coffee van more viable.

Opportunities also exist to leverage Wundowie's unique offering as a demonstration of the beginning of the iron industry in Western Australia and the potential to further interpret the history of iron and rare earth materials and industrial technology. Education-oriented tourism has shown growth on a global scale, and there is also promise in route-based

¹⁸ Tourism Western Australia (2015) *Tourism Western Australia: Fast Facts* Year Ending June 2015, Perth, Western Australia; Government of Western Australia.

tourism, bringing together tourism products of a similar theme within rural areas. The small Canadian town of Morden, located 125km from the nearest city, successfully diversified its economy around tourism products based on its past and present bentonite mining¹⁹. Morden's 'fossil centre' is located within a larger recreational and community complex and firmly taps into the self-drive tourism sector.

Other Wheatbelt towns are using short-stay (unmanned) caravan parks to attract tourists while having low ongoing running costs. Similar facilities have leveraged caravan club visits, used added attractions such as movies, made use of their proximity to larger tourist destinations or tapped into route-based tourism such as the Wheatbelt Way. Quairading, Koorda and Bindoon consider their caravan parks provide extra income for businesses in town, in turn making them more viable.

Research into the WA caravan sector showed 'grey nomads' represent 40% of caravanners who stayed at caravan parks for accommodation on a road trip, with some research suggesting a spend of \$500 per couple per week on the road²⁰. A study of 90 Queensland Caravan Club members found the biggest trigger for frequency of future trips was organised social activities, highlighting the importance of interaction in a formal or organised setting.

Over 43% of respondents had visited the Beaudesert region at least three times in the last five years and this study found the national park was sufficiently explored once, so less of a draw for future visits and the 'outback spectacular' event was highly unlikely to encourage repeat visitation due to lack of variety.

However, there was a positive correlation between additional accommodation and repeat visitation, with 'grey nomads' using a variety of accommodation due their flexibility and being able to pre-book. Accommodation variety was more important than travel cost and the study concluded that to encourage more trips, more accommodation facilities should be provided, with higher prices charged to recover the development costs, with a variety of attractions important for future visitation of 'grey nomads'¹⁸.

The idea of a short-stay caravan park facility in Wundowie was well received by attendees at the community workshop, although there were differing views on the potential location, either at the lower oval, with the option to access amenities at the hub or away from the hockey fields to the south of both ovals - so all ovals can be retained for sports. Some Wheatbelt parks use an honour system, the success of which could depend on some passive surveillance and therefore be partly dependent on the location chosen.

¹⁹ Ramsey, Doug ; Malcolm, Christopher D. (2018) *The importance of location and scale in rural and small town tourism product development: The case of the Canadian Fossil Discovery Centre, Manitoba, Canada*. Canadian Geographer / Le Géographe canadien, June 2018, Vol.62(2), pp.250-265

²⁰ Renuka Mahadevan (2018) *Understanding Senior Self Drive Tourism in Australia Using a Contingency Behavior Model*. Journal of Travel Research 2014, Vol. 53(2) 252-259

ENVIRONMENTAL BENEFITS

In areas of high environmental value, small scale tourism development is a preferable model, primarily because the infrastructure required is cheaper and less demanding of resources, and smaller visitor numbers are considered to have less impact¹⁷. The same principles could be applied to Wundowie, where a small-scale facility would be most appropriate so as not to provide pressure on the existing town's services and resources or artificially inflate the demand at peak times only.

Camping is considered a generally high impact activity ecologically as it has the potential to result in loss of vegetation cover, soil compaction, erosion, pollution and other issues such as disposal of waste, taking resources as firewood and unregulated access to natural areas¹⁷. Many of these issues can be mitigated through design and supply of sewerage services and/or formalised accommodation. Therefore, counter to the assumptions of camping as a 'low impact' activity, development of 'nature-based' tourism that does not impact on the environment relies on the provision of suitable infrastructure.

SOCIAL BENEFITS

The WA Primary Health Alliance (WAPHA) flagged Wundowie as a priority location of greatest need in the Wheatbelt, based on an analysis of social determinants, health indicators, service gaps and stakeholder feedback¹⁸. An unmanned caravan park is unlikely to offer any significant social benefits to the local community, apart from through potential flow-on employment improving the sustainability of local business and therefore maintaining the social fabric of the area.

Any facilities would need to be carefully planned so as not to disrupt the character of Wundowie, hence small-scale tourism is considered most appropriate. The development of activities and interpretation of the town's history and significance could also contribute to community pride. For example, the development of heritage interpretation for Central Maitland in NSW, a city which had experienced significant population decline, led to increased local knowledge about the region's heritage, community capacity building and created a sense of place and community pride²¹. Potential exists here to use interpretation as a vehicle to rebuild community bonds in Wundowie.

²¹ SH (2014) *Maitland Heritage Interpretation Masterplan*. Retrieved from:
<http://www.shp.net.au/interpretation.html>

Prepared by Anna Dixon Consulting
annadixonconsulting.com
hello@annadixonconsulting.com
(08) 6102 8580 | 0429 869 988

Attachment 2



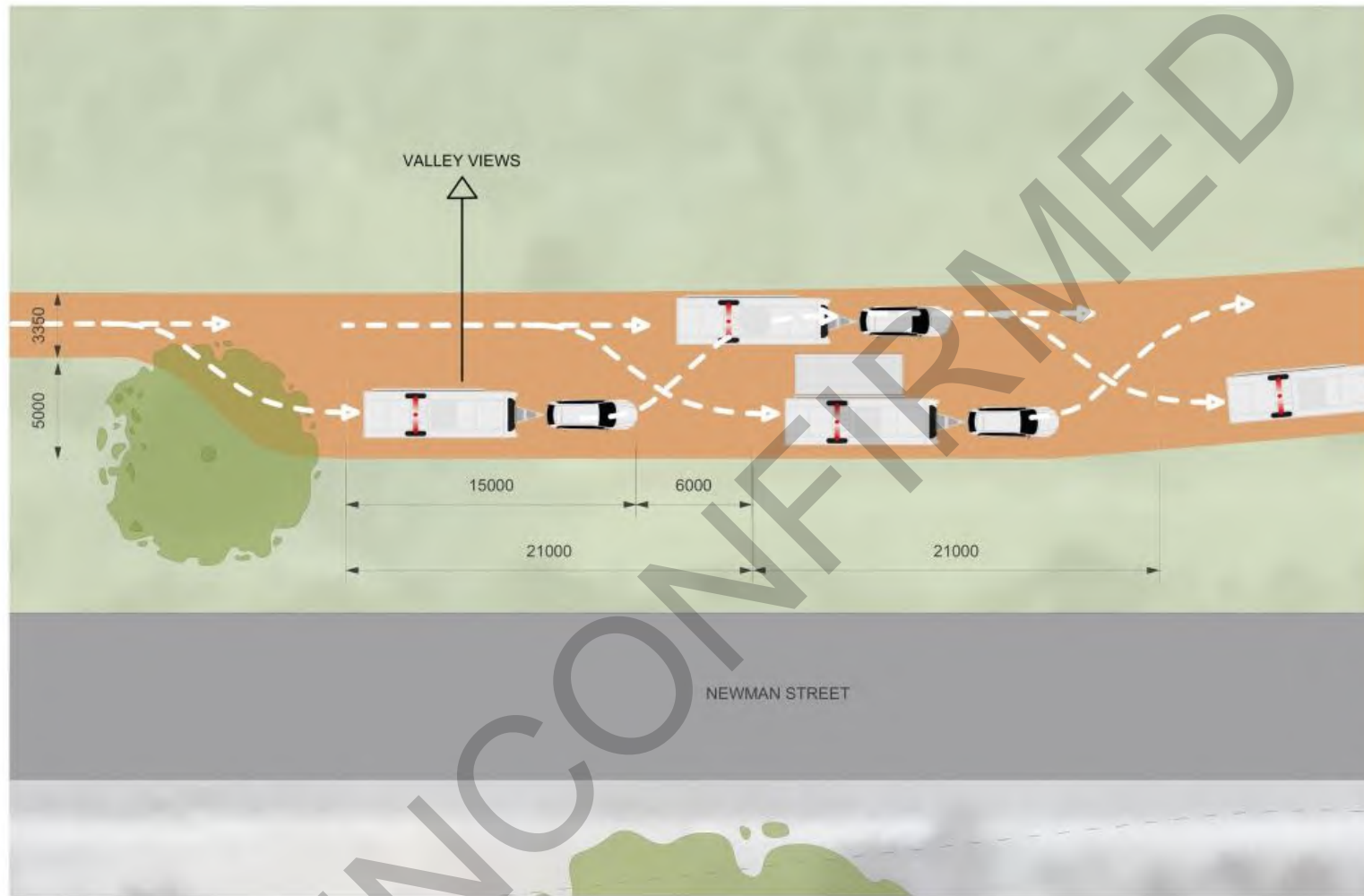

Project	Northam Camping
Address	Baker's Hill, Northam
This Sheet	Baker's Hill Caravan Bay Close-Up
Plot Date	7/6/18
Scale (A4)	1:200
Project No.	19932
Drawing No.	A102

DESIGN CONSULTANTS ONLY
 NOT FOR CONSTRUCTION
 ©2018 Copyright Slavin Architects

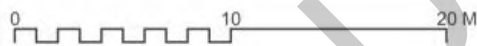

2 Baker's Hill Caravan Bay close-up
 Scale: 1:200

Slavin Architects Pty Ltd
 10 Pearce Street, North Fremantle WA 6159 Australia
 www.slavinarch.com.au
 Phone: +61 8 9400 3242
 info@slavinarch.com.au

Associations:
 Australian Institute of Architects
 Institute of Planning
 Institute of Environmental Designers
 Institute of Landscape Architects
 Institute of Urban Designers
 Institute of Environmental Engineers

LEARNING ENVIRONMENTS
 North Australia: PO Box 203
 North Fremantle WA 6159 Australia



DUAL USE
 PATH TO
 TOWN
 CENTER

Project	
Northam Camping	
Address	
Northam	
Title Sheet	
Northam Campsite Site Plan	
Plot Date	7/8/19
Drawn @A11:1000	Rev
Project No	19032
Drawing No	A103
<small> DESIGN OWNED ONLY NOT FOR CONSTRUCTION © 2019 Copyright Shire of Northam </small>	

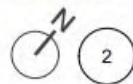
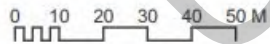

2 Northam Campsite Site Plan
 Scale: 1:1000



Stavin
 Stavin Architects Pty Ltd
 10 Pearce Street, North Fremantle, WA 6155 Australia
 www.stavin.com.au
 9493 0647-68
 4618 4502 3242
 info@stavin.com.au
 9493 0647-68
 4618 4502 3242
 info@stavin.com.au



CARAVAN PARK- MINSON AVE CARPARK
for the Shire of Northam

SK100
SITE PLAN
1:500 @ A3

Attachment 3

REPORT DETAIL



Project: Shire of Northam	Details: Budget Costing (Final)
Building: Various Project	

Item No.	Item Description	Quantity	Unit	Rate	Amount
----------	------------------	----------	------	------	--------

MINSON AVE DAY USE AREA/CARPARK

<u>Demolition & Alterations Works</u>					
1	Making good to existing carpark and modify existing some areas to new layouts		Excl.		0
2	Allow to modify entrance exit crossover to new layouts		Item		3,300
3	Remove existing line marking		Item		1,500
4	Remove existing bitumen and creating island for natural landscape	39	m2	50.00	1,950
5	Clearing the site for new carparking layout	395	m2	10.00	3,948
<u>New Works</u>					
6	Additional bitumen car parking to existing car parking including clearing the site	395	m2	85.00	33,554
7	Provision for line marking		Item		15,000
8	Wheelstops to car bays	31	No.	125.00	3,875
9	General landscape next to car parking		Excl.		
<u>Services</u>					
10	Provision for services ie. water, electrical etc.		Excl.		
<u>On Costs</u>					
11	Preliminaries, 10%		Item		7,000
12	Design contingency, 10%		Item		8,000
13	Contract contingency, 5%		Item		4,000
14	Round up		Item		874
<u>GENERAL EXCLUSIONS</u>					
15	Goods & Services Tax (G.S.T)				
16	Escalation				
17	Excavation in rock				
18	Removal of asbestos				
19	Land costs				
20	Landscaping				
21	Services				

MINSON AVE DAY USE AREA/CARPARK TOTAL

83,000

REPORT DETAIL



Project: Shire of Northam	Details: Budget Costing (Final)
Building: Various Project	

Item No.	Item Description	Quantity	Unit	Rate	Amount
----------	------------------	----------	------	------	--------

BAKERS HILL SHORT STAY AREA

<u>Demolition & Alterations Works</u>					
22	Modify existing road to accommodate for new roundabouts	251	m2	108.00	27,075
23	Upgrade Yates Street		Excl.		
<u>New Works</u>					
24	Allow for testing existing gravel		Item		1,500
25	Claycrete to existing gravel base	2,423	m2	12.00	29,080
26	Assume existing gravel base is adequate for use		Note		
<u>Services</u>					
27	Pathway light poles, approx 8m with independent solar and footing	3	No.	5,000.00	15,000
<u>On Costs</u>					
28	Preliminaries, 10%		Item		8,000
29	Design contingency, 10%		Item		9,000
30	Contract contingency, 5%		Item		5,000
31	Round up		Item		345
<u>GENERAL EXCLUSIONS</u>					
32	Goods & Services Tax (G.S.T)				
33	Escalation				
34	Excavation in rock				
35	Removal of asbestos				
36	Land costs				
37	Landscaping				
38	Services .ie. water supply etc				

BAKERS HILL SHORT STAY AREA TOTAL

95,000

REPORT DETAIL



Project: Shire of Northam	Details: Budget Costing (Final)
Building: Various Project	

Item No.	Item Description	Quantity	Unit	Rate	Amount
----------	------------------	----------	------	------	--------

NORTHAM SHORT STAY AREA

	<u>New Works</u>				
64	Allow for testing existing gravel		Item		3,000
65	Claycrete compacted gravel road	3,679	m2	12.00	44,153
66	Assume existing gravel base is adequate for use		Note		
67	Prepare ground for natural landscape	1,140	m2	2.00	2,281
	<u>Services</u>				
68	Allowance for redirect greywater dump into existing leach drains		Item		15,000
69	Pathway light poles, approx 8m with independent solar and footing	5	No.	4,000.00	20,000
	<u>On Costs</u>				
70	Preliminaries, 10%		Item		9,000
71	Design contingency, 10%		Item		10,000
72	Contract contingency, 5%		Item		11,000
73	Round up		Item		566
	<u>GENERAL EXCLUSIONS</u>				
74	Goods & Services Tax (G.S.T)				
75	Escalation				
76	Excavation in rock				
77	Removal of asbestos				
78	Demolitions				
79	Land costs				
80	Landscaping				

NORTHAM SHORT STAY AREA TOTAL

115,000

Cr S B Pollard declared an "Impartiality" interest in item 12.5.4 - Community Representation on Council Committees as a number of applicants are known to him.

Cr C R Antonio declared an "Impartiality" interest in item 12.5.4 - Community Representation on Council Committees as a number of nominees are known to him.

12.5.4 Community Representation on Council Committees

Address:	N/A
Owner:	N/A
Applicant:	N/A
File Reference:	Community Safety Committee 2.1.3.6 Nyoongar Cultural Advisory Group 2.1.3.8
Reporting Officer:	Ross Rayson, Executive Manager Community Services
Responsible Officer:	Ross Rayson, Executive Manager Community Services
Officer Declaration of Interest:	Nil
Voting Requirement:	Absolute Majority
Press release to be issued:	No

BRIEF

The purpose of this report is to provide Council with the applications for community membership of the Community Safety Committee and Nyoongar Cultural Advisory Group.

ATTACHMENTS

- Attachment 1: Nominations (provided as a separate confidential attachment to this agenda/minutes.)
Attachment 2: Terms of Reference Nyoongar Cultural Advisory Group.

A. BACKGROUND / DETAILS

Council requested expressions of interest from community members to become community representatives on the following committees:

- Community Safety Committee (2 representatives)

The objective of the Shire of Northam Community Safety Committee is to enhance the community safety and reduce criminal and anti-social behaviour through collaboration of key interests and agencies.

- Nyoongar Cultural Advisory Group (One representative from each of the following families: Ryder; Garlett; Stack; Slater; McGuire; Kickett; Moody; Davis; 2 other Aboriginal and/or Torres Strait Islander community representatives)

The objective of the Shire of Northam Nyoongar Cultural Advisory Group is to provide guidance and recommendations to the Shire of Northam on all Nyoongar related matters focusing on the BKB Centre for Nyoongar Culture & Environmental Knowledge and the development of a community wide Reconciliation Action Plan.

B. CONSIDERATIONS

B.1 Strategic Community / Corporate Business Plan

Theme Area 3: Safety and Security

Outcome 3.1: Northam residents are able to pursue the fullest life possible without fear of or hindrance from crime and disorder.

Objective: Plan and implement strategies to address crime and safety within the Shire of Northam

- increase community participation in identifying and reporting of crime
- increase community awareness and understanding of how to prevent crime and improve community safety
- work with key stakeholders and community groups to plan and implement community safety and crime prevention initiatives
- Engage with all segments of our population to understand

Theme Area 4: Environment and Heritage

Outcome 4.2: Northam honours, and is recognised for, its unique heritage and cultural identity.

Objective: There is a strong, respected and valued Aboriginal community and culture in the Shire of Northam

Theme Area 6: Governance and Leadership

Outcome 6.3: The Shire of Northam council is a sustainable, responsive, innovative and transparent organisation.

Objectives: Implement systems and processes which deliver outcomes for our community
Encourage active community participation in our local government

B.2 Financial / Resource Implications

There is a sitting fee of \$100 per person, per meeting attendance for the Nyoongar Cultural Advisory Group.

B.3 Legislative Compliance

N/A

B.4 Policy Implications

N/A

B.5 Stakeholder Engagement / Consultation

The Expressions of Interest were promoted via local print media and the Shire's social media and website.

B.6 Risk Implications

Risk Category	Description	Rating (consequence x likelihood)	Mitigation Action
Financial	Council has not budgeted for expenditure for this committee.	Low(1)	Council has budgeted costs associated with previous Aboriginal Advisory Group. Associated budget will be utilised to cover costs of this committee.
Health & Safety	Nil		
Reputation	Council perceived as not being serious about establishment of a RAP or community input into matters relating to Aboriginal cultural issues	Low (4)	Council establishes formal committee and Terms of Reference to and ensures committee is operated within established frameworks.
Service Interruption	Nil		
Compliance	Committee does not operate within established Committee frameworks	Low (2)	Ensures committee is operated within established frameworks.
Property	Nil		
Environment	Nil		

C. OFFICER'S COMMENT

Community Safety Committee

There being no expressions of interest received for the Community Safety Committee, the committee will commence without Community Representatives. Community representatives will continue to be sought.

Nyoongar Cultural Advisory Group

There were a number of expressions of interest (EOI's) received from the family groups identified. Details of the EOI's has been provided to Councillors as a confidential attachment.

Given that more nominations than positions available were received, officers have considered there are a number of ways to resolve the membership of the committee. These include:

1. Council voting on the representative from each family group, where there is more than one nomination
2. Amend the terms of reference to include up to 2 representatives from each designated family group, with 2 community representatives.

Officers believe that whilst it will result in a large Working Group, all recommended applicants will provide positive input to the advisory group and their nominations should be accepted.

The Terms of Reference for this Advisory Group (as attached) have been amended to reflect the recommended changes to the membership.

RECOMMENDATION / COUNCIL DECISION

Minute No: C.3868

Moved: Cr Ryan

Seconded: Cr Mencshelyi

There being no Expressions of Interest received the Community Safety Committee will commence meeting without community representation. Community representatives will continue to be sought.

CARRIED 10/0

One (1) member of the Gallery left the meeting at 7:05pm.

RECOMMENDATION / MOTION

Moved: Cr Ryan
Seconded: Cr Mencshelyi

That Council endorse the amended Terms of Reference of the Nyoongar Cultural Advisory Group as attached to:

- 1. Appoint up to two (2) representatives from the following family groups: Ryder; Garlett; Stack; Slater; McGuire; Kickett; Moody; Davis; 2 other Aboriginal and/or Torres Strait Islander community representatives);**
- 2. Include section 7. Tenure of Membership;**
- 3. Include section 8. Working Group; and**
- 4. Include Section 9, Payment to Committee Members.**

AMENDMENT TO MOTION

Moved: Cr Little
Seconded: Cr Pollard

That the words 'two (2) representatives' be replaced with 'one (1) representative' in item 1 of the motion.

LOST 3/7

Debate was held around the motion. Cr Little, Cr Pollard spoke for the motion. Cr Ryan spoke against the motion. Cr Little used his right of reply to close the debate.

RECOMMENDATION / COUNCIL DECISION

Minute No: C.3869

Moved: Cr Ryan
Seconded: Cr Mencshelyi

That Council endorse the amended Terms of Reference of the Nyoongar Cultural Advisory Group as attached to:

- 1. Appoint up to two (2) representatives from the following family groups: Ryder; Garlett; Stack; Slater; McGuire; Kickett; Moody; Davis; 2 other Aboriginal and/or Torres Strait Islander community representatives);**
- 2. Include section 7. Tenure of Membership;**
- 3. Include section 8. Working Group; and**
- 4. Include Section 9, Payment to Committee Members.**

CARRIED 10/0

The Shire President advised that there would be a short intermission at 7:12pm.

The Gallery and the Manager Health & Environment left the meeting at 7:12pm.

The meeting reconvened at 7:15pm, the Gallery and Manager Health and Environment did not return to the meeting.

RECOMMENDATION / COUNCIL DECISION

Minute No: C.3870

Moved: Cr Ryan
Seconded: Cr Mencshelyi

That Council appoint the following community members to the Nyoongar Cultural Advisory Group:

Ryder:

- Joan Parfitt (nee Ryder)**

Garlett:

- Rod Garlett**
- Kirk Garlett**

Stack:

- Elizabeth Stack
- Kate Stack

McGuire:

- Deborah Moody (nee McGuire)
- Marie Nickels (nee McGuire)

Kickett:

- Boyd Kickett

Moody:

- Donna Moody

Davis:

- Jermaine Davis
- Kathy Davis

Other Aboriginal and/or Torres Strait Islander Representatives:

- Brenda DeAtta
- Yvonne Kickett (nee Winmar)

**CARRIED 10/0
BY ABSOLUTE MAJORITY**

Attachment 1

**TERMS OF REFERENCE
SHIRE OF NORTHAM NYOONGAR CULTURAL ADVISORY GROUP**

**TERMS OF REFERENCE
SHIRE OF NORTHAM NYOONGAR CULTURAL ADVISORY GROUP**

1. Objectives of the Shire of Northam NYOONGAR CULTURAL ADVISORY Group (NCAG)

The primary objective of NCAG is to provide guidance and recommendations to the Shire of Northam on all Nyoongar related matters focusing on the BKB Centre for Nyoongar Culture & Environmental Knowledge and the development of a community wide Reconciliation Action Plan.

2. Powers of the Northam NCAG

NCAG is a formally appointed committee of Council and is responsible to that body. NCAG does not have executive powers or authority to implement actions in areas over which the CEO has legislative responsibility and does not have any delegated financial responsibility. NCAG does not have any management functions and cannot involve itself in management processes or procedures.

NCAG is to report to Council and provide appropriate advice and recommendations on matters relevant to its terms of reference in order to facilitate informed decision-making by Council in relation to the legislative functions and duties of the local government that have not been delegated to the CEO.

3. Membership

The Advisory Group shall consist of elected members, designated Shire of Northam employees and Aboriginal and Torres Strait Islander community members as follows:

- Two(2) Elected Members;
- Up to Two (2) representative from each of the following families
 - Ryder
 - Garlett
 - Stack
 - Slater
 - McGuire
 - Kickett
 - Moody
 - Davis
- Two other Aboriginal and/or Torres Strait Islander Community Representatives
- Shire of Northam CEO or nominated Executive Manager.
- Member for Central Wheatbelt, State Legislative Assembly
- The CEO and or their nominee is to attend all meetings to provide advice and guidance to the committee. They do not have voting rights on the committee
- The local government shall provide secretarial and administrative support to the committee.

**TERMS OF REFERENCE
SHIRE OF NORTHAM NYOONGAR CULTURAL ADVISORY GROUP**

4. Meetings

The NCAG shall meet at least four times annually.

Additional meetings shall be convened at the discretion of the presiding member.

5. Reporting

Minutes and recommendations of each NCAG meeting shall be presented to the next Ordinary Meeting of the Council.

The NCAG is responsible for liaising with all relevant business units to complete and submit the RAP Impact Measurement Questionnaire to Reconciliation Australia annually.

6. Duties and Responsibilities

The following activities will be carried out by the NCAG:

- Provide guidance and assistance to Council on the future development of the BKB.
- Provide input and advice in relation to the development of a Shire of Northam Reconciliation Action Plan.
- Meet with the Full Shire of Northam Council, not less than once each year to discuss progress of the Reconciliation Action Plan and BKB
- Develop a RAP within the context of the Shire of Northam's core business and in-line with:
 - Over-arching community strategic plan and corporate business plan.
 - Any existing Aboriginal and Torres Strait Islander employment strategy
 - Any existing supplier diversity strategy
 - Any existing equity and diversity policies.
- Establish a collaborative/consultative process for engaging staff across the organisation so that they can provide ideas for the RAP and comment on drafts.
- Develop a project plan and timeline to development, launch and begin implementing the RAP, including consultation with Reconciliation Australia at regular intervals.
- Regularly liaise with relevant business units and key stakeholders to review progress of RAP actions and:
 - Report RAP progress to internal and external stakeholders, including Reconciliation Australia, Shire of Northam elected members and staff, and Aboriginal and Torres Strait Islander stakeholders
 - Reflect on key learnings in the development of new RAPs.
 - Consider RAP implementation issues and consult with relevant business units to find solutions.
- Develop a new RAP when the current plan expires.

**TERMS OF REFERENCE
SHIRE OF NORTHAM NYOONGAR CULTURAL ADVISORY GROUP**

7. Tenure of Membership

Shall be in accordance with the Local Government Act, section 5.11, i.e. until the next scheduled local government Ordinary Elections.

8. Working Group

8.1. Chairperson

The members shall appoint the Chairperson.

8.2. Secretary

As appointed by the Executive Manager Community Services.

8.3. Quorum

The quorum at any meeting shall be half plus one of the number of offices. Therefore the number for a Quorum shall be 11 voting members.

8.4. Voting

Shall be in accordance with the Local Government Act, Section 5.21

8.5. Minutes

Shall be in accordance with the Local Government Act, Section 5.22.

8.6. Who Acts If No Presiding Member

Shall be in accordance with the Local Government Act, Section 5.14.

8.7. Meetings

Meetings shall be generally open to the public pursuant to Section 5.23 of the Local Government Act and include question time for members of the pursuant to Section 5.24 of the Local Government Act.

8.8. Members Interests to be Disclosed

Members of the Working Group are bound by the provisions of the Local Government Act Section 5.65 with respect to disclosure of financial, impartiality or proximity interests.

8.9. Code of Conduct

Members of the Working Group are bound by Council's Code of Conduct.

9. Payment to Committee Members

All Committee Members, who are not a member of Council, shall be reimbursed reasonable expenses for attending Committee Meetings in accordance with section 5.100 (2) (a) of the Local Government Act 1995. The amount of the expense to be reimbursed shall not exceed \$100 per meeting.

13. MATTERS BEHIND CLOSED DOORS

Cr J E G Williams declared an "Impartiality" interest in item 13.1 - Confidential Shire of Northam Licensing Services as one of her non dependent children holds one of the staff positions affected by this decision.

Cr M I Girak declared an "Impartiality" interest in item 13.1 - Confidential Shire of Northam Licensing Services as she knows the Senior Licensing Officer and some of the customer service staff that may be affected. The extent of her interest is minimal and it will not affect her decision.

RECOMMENDATION / COUNCIL DECISION

Minute No: C.3871

Moved: Cr Della
Seconded: Cr Girak

That Council, in accordance with section 11.1(i) of the Shire of Northam Standing Orders Local Law 2018 and Section 5.23 (2) (a) of the Local Government Act 1995, meet behind closed doors to consider agenda item 13.1 - Confidential Shire of Northam Licensing Services.

CARRIED 10/0

13.1 CONFIDENTIAL SHIRE OF NORTHAM LICENSING SERVICES

RECOMMENDATION / COUNCIL DECISION

Minute No: C.3872

Moved: Cr Mencshelyi
Seconded: Cr Ryan

That Council:

1. Authorise the CEO to terminate the Licencing Agreement with the Department of Transport should they find a suitable tenderer.
2. Should a suitable tenderer not be engaged, the Shire is willing to continue until the original end of the contract'.
3. Endorse the CEO offering the Senior Licencing Officer redundancy when the licencing service ceases to be carried out at the Shire; and
4. Endorse the amended restructure of the administration department when the Licencing service ceases to be carried out at the Shire.

CARRIED 9/1

It was raised whether the words 'include a clause stating' can be removed from item 2 of the motion, with the approver of the mover and seconder these words were removed.

Debate was held around the motion. Cr Mencshelyi and Cr Ryann spoke for the motion, Cr Pollard spoke against the motion. Cr Mencshelyi used his right of reply to close the debate.

RECOMMENDATION / COUNCIL DECISION

Minute No: C.3873

Moved: Cr Little

Seconded: Cr Mencshelyi

That Council move out from behind closed doors.

CARRIED 10/0

The Gallery and Manager Health and Environment returned to the meeting at 7:29pm.

14. MOTIONS OF WHICH PREVIOUS NOTICE HAS BEEN GIVEN

Nil.

15. URGENT BUSINESS APPROVED BY DECISION

Nil.

16. DECLARATION OF CLOSURE

There being no further business, the Shire President, Cr C R Antonio declared the meeting closed at 7:30pm.

"I certify that the Minutes of the Ordinary Meeting of Council held on Wednesday, 22 January 2020 have been confirmed as a true and correct record."

_____ President

_____ Date